

Tiger Touch

Operator's Manual

Version 7.0



Useful Avolites phone numbers: -

Avolites England

Sales and service* (+44) (0) 20 8965 8522

Service out of hours* (+44) (0) 831 17 8888

Fax (+44) (0) 20 8965 0290

Email support@avolites.com

Website <http://www.avolites.com>

Before contacting Avolites for service enquiry please ensure that you have the product serial number and the software version. The serial number can be found on the back of the desk; the software version is displayed on the menu prompt when the Tiger Touch is switched to System mode.

The latest version of this manual and console software can be downloaded from the Avolites website.

The small print :

No Liability for Consequential Damages

Avolites has a policy of continuous product and documentation improvement. As such the detail within this manual may not match the operation of the console.

In no event shall Avolites be liable for any direct, indirect, special, incidental, or consequential damages or loss whatsoever (including, without limitation, damages for loss of profits, business interruption, or other pecuniary loss) arising out of the use or inability to use the console even if Avolites Ltd. has been advised of the possibility of such damages. Because some jurisdictions do not allow the exclusion or limitation of liability for consequential or incidental damages, the above limitation may not apply to you.

Avolites Ltd recognise that all trademarks within the manual are the property of their respective owners.

Reprint and revision history:

Titan Universal Manual v7: July 2013

Written by Tim Mitchell, Sabre Technology Ltd
<http://www.sabretechnology.co.uk>

SECTIONS

1. QUICK START	13
2. SETTING UP AND USING THE CONSOLE	17
3. PATCHING	42
4. CONTROLLING DIMMERS AND FIXTURES	59
5. PALETTES	81
6. SHAPES AND PIXEL MAPPER EFFECTS	93
7. CUES	125
8. CHASES	143
9. CUE LISTS	153
10. RUNNING THE SHOW	171
11. REMOTE CONTROL	183
12. USER SETTINGS AND OTHER OPTIONS	189
13. WORKING WITH FIXTURE PERSONALITIES	205
14. NETWORKING THE CONSOLE	209
15. USING DIFFERENT AVOLITES CONSOLES	219
16. RELEASE NOTES	223
17. GLOSSARY OF TERMS	245



This icon shows important information which you should know about to avoid damage to your console or loss of important data.



This icon shows information which is useful to know.



This icon shows handy tips which will help you use the console more efficiently.

CONTENTS

1.	Quick Start	13
1.1	Patching fixtures	13
1.2	Controlling fixtures	13
1.3	Programming cues and chases.....	14
1.4	Programming palettes	15
1.5	DMX / network setup	15
2.	Setting up and using the console	17
2.1	Guide to the Tiger Touch	17
2.2	Connecting up.....	21
2.2.1	Cautions	21
2.2.2	Connecting mains power	21
2.2.3	Starting up and shutting down.....	21
2.2.4	Titan Healthcheck	22
2.2.5	Connecting DMX lines.....	22
2.2.6	Connecting a monitor	23
2.2.7	Other connections.....	23
2.3	Using the touch screen and monitor	24
2.3.1	Workspace windows	24
2.3.2	The menu area of the touch screen	28
2.3.3	The toolbar	29
2.3.4	The Heads-Up Display (HUD).....	30
2.3.5	Visualiser	31
2.3.6	Key profiles.....	32
2.3.7	Undo/Redo.....	32
2.3.8	Key macro buttons.....	32
2.3.9	Keyboard shortcuts	33
2.3.10	Locking the console.....	34
2.4	Titan Simulator	34
2.4.1	Installing Titan Simulator	35
2.4.2	Running Titan Simulator	35
2.4.3	Using Virtual Panel with a console	35
2.5	Loading and saving shows	36
2.5.1	Saving the show	36
2.5.2	Loading a show	37
2.5.3	Importing parts of other shows.....	38
2.5.4	Autosave	39
2.5.5	Backing up existing show files to USB pen drive.....	40
2.6	Clearing the console.....	40
2.7	Creating reports	40
3.	Patching	42
3.1	Patching new fixtures or dimmers	42
3.1.1	Fixture select buttons and handles	42
3.1.2	Patching dimmers	43
3.1.3	Patching moving light fixtures.....	44
3.1.4	Visualiser Auto Patch.....	46
3.1.5	Patching fixtures with multiple cells (sub fixtures)	46
3.1.6	Patching by RDM.....	47
3.1.7	Finding a lost fixture	47
3.2	Changing the patch.....	48
3.2.1	Patch View	48
3.2.2	View detailed fixture information.....	49
3.2.3	Changing DMX address using Patch menu	50
3.2.4	Setting legends	51
3.2.5	DMX view window	51
3.2.6	Fixture Exchange.....	52
3.2.7	Update personalities.....	53
3.3	Copying, moving and deleting fixtures	54
3.3.1	Copying or moving a patched fixture	54
3.3.2	Using copied fixtures	54
3.3.3	Deleting a patched fixture	54
3.4	Advanced options	55
3.4.1	Swap pan and tilt.....	55
3.4.2	Invert attributes	55

3.4.3	Attribute limits	56
3.4.4	Fixture / Attribute curves	56
3.4.5	Freeze fixtures or attributes	57
3.4.6	Editing the personality.....	57
4.	Controlling dimmers and fixtures	59
4.1	Using the select buttons and wheels.....	59
4.1.1	Selecting fixtures and dimmers for control	59
4.1.2	Setting fixtures to a start position (Locate)	60
4.1.3	Clearing selection.....	61
4.1.4	Fixtures with multiple cells/subfixtures	62
4.1.5	Changing attributes using the wheels	63
4.1.6	Setting attributes using the touch screen	65
4.1.7	Setting attributes from the softkeys	67
4.1.8	Adjusting attributes with the @ buttons	68
4.1.9	Selecting fixtures and dimmers by number (Channel)	68
4.1.10	Selecting using a pattern	69
4.1.11	Selecting fixtures which are in a palette or playback	70
4.1.12	Attribute groups – IPCGBES-FX.....	71
4.1.13	Using fixture groups	71
4.1.14	Fixture Order and Fixture Layout in groups.....	72
4.1.15	Stepping through selected fixtures one at a time.....	74
4.1.16	Highlighting the selected fixture with Prev/Next	74
4.1.17	Flash selected fixtures to full	74
4.1.18	Turn off unselected fixtures.....	74
4.1.19	Align fixtures.....	74
4.1.20	Flip	75
4.1.21	Fan mode.....	75
4.1.22	Setting fixture/attribute times.....	78
4.2	Viewing and using numerical values	79
4.2.1	The Channel Grid window.....	79
4.3	Advanced options	80
4.3.1	The Fixture Tools / Menu Latch button.....	80
4.3.2	Lamping fixtures on and off.....	80
5.	Palettes	81
5.1	Creating palettes	82
5.1.1	Which attributes are stored in palettes.....	82
5.1.2	Storing a palette.....	82
5.1.3	Quick record	84
5.1.4	Setting legends for palettes.....	85
5.1.5	Creating an effects palette (shape or pixel mapper)	86
5.1.6	Creating a time palette	86
5.2	Recalling palettes	87
5.2.1	Recalling a palette value	87
5.2.2	Palette pages	87
5.2.3	Quick palettes with no fixtures selected	87
5.2.4	Setting palettes to all fixtures in a playback	87
5.3	Editing palettes	88
5.3.1	Viewing and editing the content of palettes	88
5.3.2	Changing the content of palettes	88
5.3.3	Updating palettes used in a playback.....	89
5.4	Copying, moving and deleting palettes	89
5.4.1	Copying or moving a palette.....	89
5.4.2	Deleting palettes.....	90
5.5	Timing with palettes.....	90
5.5.1	Palettes with saved times.....	90
5.5.2	Manually overriding palette times.....	90
5.5.3	Manual fixture overlap when recalling palettes.....	91
5.5.4	Master Time for palettes	91
6.	Shapes and Pixel Mapper effects	93
6.1	Creating effects.....	94
6.1.1	Creating a shape	94
6.1.2	Changing size and speed of a shape.....	95
6.1.3	Changing the phase of a shape across multiple fixtures	96
6.1.4	Creating Pixel Mapper effects	97
6.1.5	Pixel mapper Layer Masters.....	100
6.2	Editing shapes and effects	100

6.2.1	Editing shapes and effects in cues	100
6.2.2	Selecting a running shape to edit	101
6.2.3	Changing fixture order in a shape	101
6.2.4	Removing or adding fixtures	101
6.2.5	Reversing a shape	102
6.2.6	Deleting shapes	102
6.3	Advanced options	102
6.3.1	Fading shape size and speed	102
6.4	Pixel Mapper examples	102
6.4.1	Randomising effects	102
6.4.2	Overlaying effects	106
6.4.3	Creative use of fixture layouts	108
6.4.4	Other Layout Editor tools	112
6.4.5	Playback Order and Priorities	113
6.4.6	Displacement and Layer Properties	117
6.4.7	Spawn and Pre-Spool	120
7.	Cues	125
7.1	Creating a cue	125
7.1.1	How the Tiger Touch works when programming	125
7.1.2	Creating a cue	126
7.1.3	Quick Build cues	127
7.1.4	Using shapes/effects in cues	127
7.1.5	Blind mode	127
7.2	Using a cue	128
7.2.1	HTP and LTP	128
7.2.2	Playing back a cue	128
7.2.3	Changing playback pages	128
7.2.4	Viewing active playbacks	129
7.2.5	Speed Masters	129
7.2.6	Releasing running playbacks	130
7.2.7	Turning off individual fixtures/attributes in playbacks	130
7.3	Editing cues	130
7.3.1	Editing a cue by merging	130
7.3.2	Updating stored values and palettes used in a cue	131
7.3.3	Playback and Cue view	131
7.3.4	Using parts of existing cues - the Include function	133
7.3.5	Removing attributes from cues using "Off"	133
7.4	Copying, moving, linking and deleting	134
7.4.1	Copying or moving a cue	134
7.4.2	Deleting a cue	135
7.5	Cue timing	135
7.5.1	Setting fade times and Overlap for a cue	135
7.5.2	Changing fixture order	137
7.5.3	Setting attribute fade times for a cue	138
7.5.4	Editing times in the programmer	139
7.6	Advanced options	139
7.6.1	Release mask	139
7.6.2	Shape size/speed on fader	140
7.6.3	Curve	140
7.6.4	Locking a playback onto a handle	140
7.6.5	Playback priority	140
7.6.6	Blind mode	141
7.6.7	Key Profile	141
8.	Chases	143
8.1	Creating a chase	143
8.1.1	Programming a chase	143
8.1.2	Creating a chase with Quick Build	144
8.2	Playback	144
8.2.1	Playing back a chase	144
8.2.2	Connecting a chase for control	145
8.2.3	Setting speed and crossfade for a chase	145
8.2.4	Manually controlling the steps of a chase	146
8.2.5	Changing chase direction	146
8.2.6	Jumping to a step	146
8.3	Editing a chase	147
8.3.1	Opening a chase for editing	147
8.3.2	Editing a chase using Unfold	147

8.4	Copying, moving, linking and deleting	148
8.4.1	Copying or moving a chase	148
8.4.2	Deleting a chase	148
8.4.3	Deleting a step from a chase	148
8.5	Chase timing.....	148
8.5.1	Global timings for chases	148
8.5.2	Individual cue times in chases	150
8.5.3	Setting attribute fade times for a cue in a chase	151
8.6	Advanced options	151
8.6.1	Loop/Stop on Final Cue.....	151
8.6.2	Forwards/backwards/bounce/random	151
8.6.3	Cue linking.....	152
8.6.4	Renumber cues.....	152
9.	Cue Lists	153
9.1	Creating a cue list.....	153
9.1.1	Programming a cue list	153
9.1.2	Changing legends for cues in a cue list	155
9.1.3	Autoloading a playback within a cue list	155
9.1.4	Running a key macro from a cue list.....	156
9.1.5	Keyboard shortcuts/syntax for cue lists	156
9.2	Cue List playback	157
9.2.1	Running a cue list	157
9.2.2	Killing a cue list	157
9.3	Editing cue lists	158
9.3.1	Playback View window.....	158
9.3.2	Editing values in Cue View window	158
9.3.3	Moving and copying cues	158
9.3.4	Editing a cue list using Unfold	159
9.3.5	Using Update to change tracked cues	160
9.3.6	Editing a cue list which is running	160
9.3.7	Editing a cue list while recording	161
9.3.8	Disabling a cue	161
9.4	Copying, moving, linking and deleting	161
9.4.1	Copying or moving a cue list	161
9.4.2	Deleting a cue list	162
9.4.3	Deleting a cue from a cue list	162
9.5	Cue list timing.....	162
9.5.1	Time and fade options for Cue Lists.....	162
9.5.2	Cue linking & Link Offset.....	163
9.5.3	Individual attribute fade times.....	164
9.5.4	Fixture overlap	164
9.5.5	Running a cue list to timecode.....	165
9.6	Advanced options	166
9.6.1	Release mask	166
9.6.2	Fader mode.....	167
9.6.3	Handle Paging	167
9.6.4	Cue Options	167
9.6.5	Autoload	167
9.6.6	Macro Links.....	167
9.6.7	Key Profile	168
9.6.8	Shape Size/Shape Speed	168
9.6.9	Tracking	168
9.6.10	Move In Dark (MID) functions.....	168
9.6.11	Fire first cue option	169
10.	Running the show	171
10.1	Playback controls.....	171
10.1.1	Back up the show.....	171
10.1.2	Label the console	171
10.1.3	Run mode	171
10.1.4	Grand Master fader	171
10.1.5	Assignable Master faders.....	171
10.1.6	Speed Masters	172
10.1.7	Group Masters	172
10.1.8	Flash and swop buttons	173
10.1.9	Playback priority	173
10.1.10	Preset playbacks	173
10.1.11	Locking a playback onto the same handle on every page.....	174

10.1.12	Viewing active playbacks	174
10.1.13	Blind mode	175
10.1.14	Busking with palettes	175
10.2	Using multiple on-screen workspaces	176
10.2.1	View menu	176
10.3	Organising the console	176
10.3.1	Using the Move function	176
10.4	Set List window	176
10.5	MIDI or DMX remote triggering	177
10.5.1	Connecting remote trigger sources	178
10.5.2	Setting up remote triggering	178
10.5.3	Classic Pearl MIDI triggers	179
10.6	Running a second console as backup	180
10.6.1	Setting up consoles for backup	180
11.	Remote control	183
11.1	Setting up the remote	183
11.1.1	Using an existing network	184
11.1.2	Network setup using a dedicated access point	184
11.2	Operating the remote	184
11.2.1	Keypad	185
11.2.2	Controlling fixtures	185
11.2.3	Recording groups and palettes	187
12.	User Settings and other options	189
12.1	Configuring the Workspace	189
12.1.1	Opening workspace windows	189
12.1.2	Selecting and positioning workspace windows	189
12.1.3	Saving workspaces	190
12.1.4	Compatibility windows for Pearl Expert shows	191
12.1.5	Configuring an external monitor	191
12.2	Key Profiles	192
12.2.1	Creating and editing key profiles	192
12.2.2	Selecting a Key Profile	194
12.2.3	Individual Key profiles for playbacks	194
12.3	The System menu	194
12.3.1	TitanNet Security	194
12.3.2	Network Settings	194
12.3.3	User Settings	194
12.3.4	Key Profiles	195
12.3.5	Wipe	196
12.3.6	DMX settings	196
12.3.7	Triggers	196
12.3.8	Display Setup	196
12.3.9	Assign mastering	196
12.4	DMX output mapping	196
12.4.1	Configuring DMX outputs	196
12.4.2	TitanNet Overview	198
12.5	Curves	198
12.6	Upgrading the software	202
12.7	Recovering/reinstalling the system	202
12.7.1	Booting from USB recovery stick	203
12.7.2	Installation Instructions	203
12.7.3	After Installation	203
12.7.4	Front panel button mapping for BIOS	204
13.	Working with Fixture Personalities	205
13.1.1	Downloading fixture personalities from Avolites	205
13.1.2	Updating the personality library on the console	206
13.1.3	User/custom personalities	206
13.1.4	Requesting a new fixture personality	207
13.1.5	Reporting a personality bug to Avolites	207
13.1.6	In an emergency	207
14.	Networking the console	209
14.1	Controlling fixtures over a network	209
14.1.1	Setting IP address	209
14.1.2	Setting up DMX outputs	210

14.1.3	A simple Art-Net system	210
14.1.4	Setting up an Art-Net system	211
14.1.5	Additional Art-Net Resources	213
14.2	Connecting to a simulator with ACDI	213
14.2.1	ACDI	213
14.3	Module Setup.....	214
14.4	Using Active Fixtures with CITP	214
14.4.1	Example CITP setup	215
14.5	All about IP addressing.....	215
14.5.1	Setting your IP address	215
14.5.2	Subnet Masks.....	216
14.5.3	Choosing an IP address and Subnet Mask.....	216
14.5.4	Automatically assigning IP addresses (DHCP)	217
14.5.5	Private IP address ranges.....	217
15.	Using different Avolites consoles	219
15.1	The console controls	219
15.2	Programming features in Titan	220
16.	Release notes	223
16.1	Version 7.0	223
16.1.1	Upgrade instructions.....	223
16.1.2	New Features	224
16.1.3	Improvements.....	231
16.1.4	Changes	232
16.1.5	Bugs fixed.....	233
16.1.6	Known issues	240
16.2	Version 6.2	240
16.2.1	Upgrading from: 6.1:	240
16.2.2	Improvements.....	240
16.2.3	Changes	241
16.2.4	Bugs fixed.....	241
16.2.5	Known Issues	241
16.3	Version 6.1	242
16.3.1	Upgrading from: 6.0:	242
16.3.2	Changes	242
16.3.3	Bugs fixed.....	242
17.	Glossary of terms	245
INDEX		251

1. Quick Start

This section is a quick guide on how to do most things on the Tiger Touch. Each section has a link to take you to the appropriate manual section for more details.

Softkeys are shown in square brackets like [This].

1.1 Patching fixtures

Press Patch, [Dimmers] or [Fixtures].

For Fixtures, from the softkeys choose fixture manufacturer (type on keyboard to filter the list) then fixture type, then fixture mode.

Set [DMX Line] and [Address]. Console will automatically set these if you don't change them.

Press buttons in the Fixtures window to patch the fixture. (Section 3.1.3, p44).

To patch a number of dimmers or fixtures at once, drag over buttons to draw a selection box on the screen. Or, set [Quantity] in the patch menu.

To change DMX address or line, use [Repatch Fixtures]. (Section 3.2, p48).

View fixture patch

To see an overview screen of how the console is patched, press View then Patch (Section 3.2.1 , p48).

Setting fixture options

Press Patch, [Edit Fixtures], or use the Patch View screen.

1.2 Controlling fixtures

Select fixtures for control by pressing select buttons.

Press Locate to "home" selected fixtures with lamp on. . (Section 4.1.2. p60). Hold locate and press attribute button to remove that attribute from the locate (e.g. to locate without changing pan/tilt, hold Locate and press Pan/Tilt).

Select attribute to control using attribute bank buttons (right hand edge of console) , then turn the wheels to set fixture. Display shows which attribute each wheel is controlling. (Section 4.1.5, p63).

Open Attribute window onscreen (View, Attribute Options) to select attributes from buttons. (Section 4.1.6, p65).

Use Palettes to store often-used colours, positions etc. for instant recall, see next page.

Shapes (effects)

Select fixtures. The order of fixture selection is used by shapes.

At top menu press [Shapes and Effects], [Shape Generator], [Create]. Select attribute of shape then select a shape to run. (Section 6.1.1, p94).

Or from the Shape Library window (View, [Open Workspace Window], [Shape Library]) you can select a shape directly. Filter the list of shapes using the attribute buttons.

Use the wheels and [Adjust Speed, Size and Phase]/[Adjust Phase, Spread and Offset] to configure the shape.

Fixture Groups

Fixtures may be grouped for quick selection, press Group, [Record Group], select fixtures for group, set legend using [Provide a legend], press [Store]. Order of fixture selection is remembered for use with shapes. (Section 4.1.13, p71).

1.3 Programming cues and chases

Cues

Set up the look to be recorded.

Press Record Cue.

Set [Record Mode] to Channel (saves only modified attributes), Fixture (saves all attributes of fixtures which have been modified or are selected), Stage (saves all attributes of all fixtures with nonzero dimmer), or Quick Build (merges palettes and playbacks into the cue when you select them).

To store, press blue Select button on playback fader, or press button in Playbacks window. (Section 7.1.2, 126).

Chases

Press Record Chase.

Press blue Select button on a playback fader, or press button in Playbacks window.

Set up the look for the first step, press playback select button to store. Repeat until all steps stored. Quick Build mode can be used to merge palettes and cues into chase steps.

Press Exit to finish storing chase steps. (Section 8.1.1, 143).

Timings

All times (cue times and fixture attribute times) are stored in the programmer and are saved when you store a cue.

To edit times in the programmer before saving, press the Times button (previously labelled "Set" on Titan Mobile/Sapphire Touch and "Next Time" on Pearl Expert/Tiger Touch).

For chases, speed and fade can be set with wheels A and B when the chase is running.

To edit times in a saved cue, at top level menu press [Edit Times] then the select button for the playback. Timing options are set from softkeys.

[Fixture Overlap] sets each fixture to fade in sequence (100%=all together, 0%=fixture waits for previous one to complete).

[Attribute times] sets individual fade times for different attributes.

[Fixture order] changes sequence for shapes and Overlap. (Section 8.5, p148).

Cue Lists

Cues may be stored in a Cue List which allows a full show to be run from a Go button. Chases can be included using Autoload.

1.4 Programming palettes

Set up the attributes to be recorded. If attribute is the same for all fixtures of one type (e.g. colour), only one fixture need be set up and palette will be "shared".

Press Record Palette.

Use [Set Mask] to choose attributes to record/exclude.

Press a grey palette button to store, or press a button in one of the Colours/Positions/Gobos windows. (Section 5.1.2, p82).

To recall palette, select fixtures, select recall mask using Attribute Bank buttons, press palette button.

To set a legend, press [Set Legend] then the palette's button. Press [Picture] to draw a picture legend.

Quick Record

Press an unused button in one of the windows – the button turns red with a +. Press again to save the palette. The mask is automatically set to match the window (e.g. Positions window is masked for only position attributes).

Busking with palettes

To fade palettes when busking a show, select fixtures, type fade time on the keypad then recall the palette (you have to do this each time). If no fixtures selected, palette will recall to all applicable fixtures.

To set fixture overlap, type 0-100 then press [Set Overlap], then recall the palette.

To set a fade time for all palettes, press Palette then [Master Time]. (Section 5.5, p90). Faded palettes do not go into the programmer so don't use fades when programming.

1.5 DMX / network setup

The console can output up to 12 universes of DMX (called DMX Lines) which may be routed to the 4 XLR sockets or over Ethernet. The Pro versions of Pearl Expert and Tiger Touch can output 16 Universes. The Titan One dongle is limited to a single universe. By connecting further DMX processing nodes to the network using TitanNet, you can control up to 64 universes.

Switch to System mode, press [DMX Settings].

Select a Node on the left (where the DMX is going to), click the blue arrow. On the right, select the DMX line it will be fed by. The 'i' buttons set properties for Nodes/Lines. (Section 5.5, p196).

To change the IP address of the console, press [Network Settings] in System mode (Section 14.1.1, p209).

To change User Settings which let you personalise how the console works, hold down Avo and select [User Settings] (Section.12.3.3, p194).

2. Setting up and using the console

Welcome to the Tiger Touch from Avolites. This manual is a reference guide to all the functions of the console.

We explain things in the order you're most likely to use them, so we start with how to set up the console, then look at patching lights, controlling lights and how to program cues.

2.1 Guide to the Tiger Touch

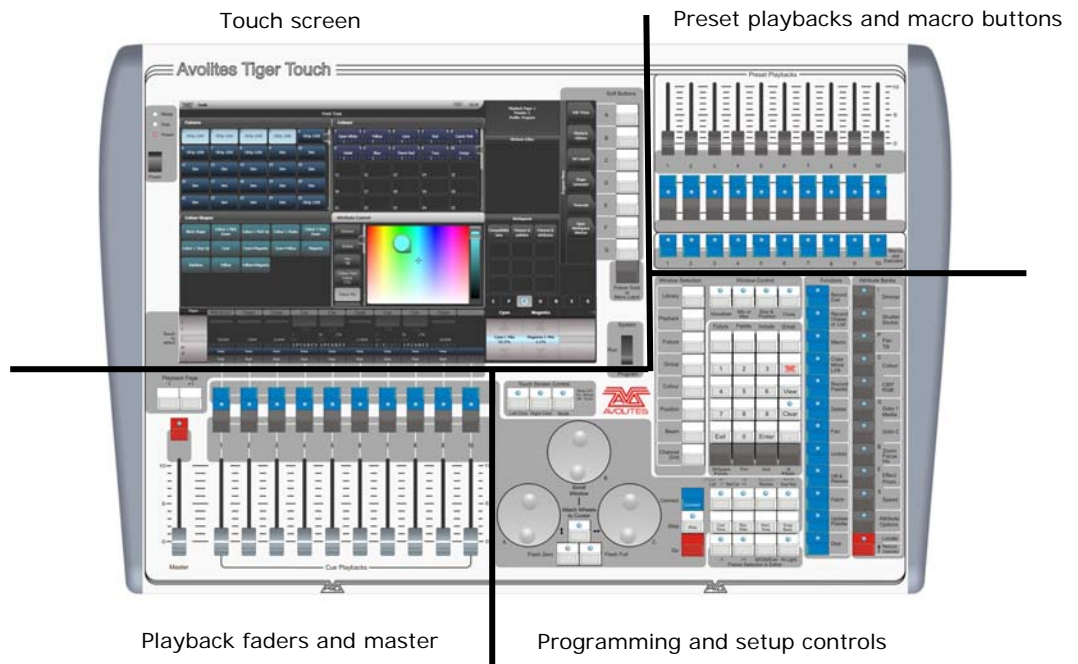

The Tiger Touch has four main control areas:

The **Touch screen** contains fixture, palette and group select buttons. It also shows legends for the playback faders and shows the current menu page and softkey buttons on the top right of the screen.

The **Playback faders** select and control cues and programs

The **Preset playbacks** give you additional (unpaged) playbacks and the **macro buttons** allow storage of frequent key sequences.

The **Programming and setup controls** configure and program the console

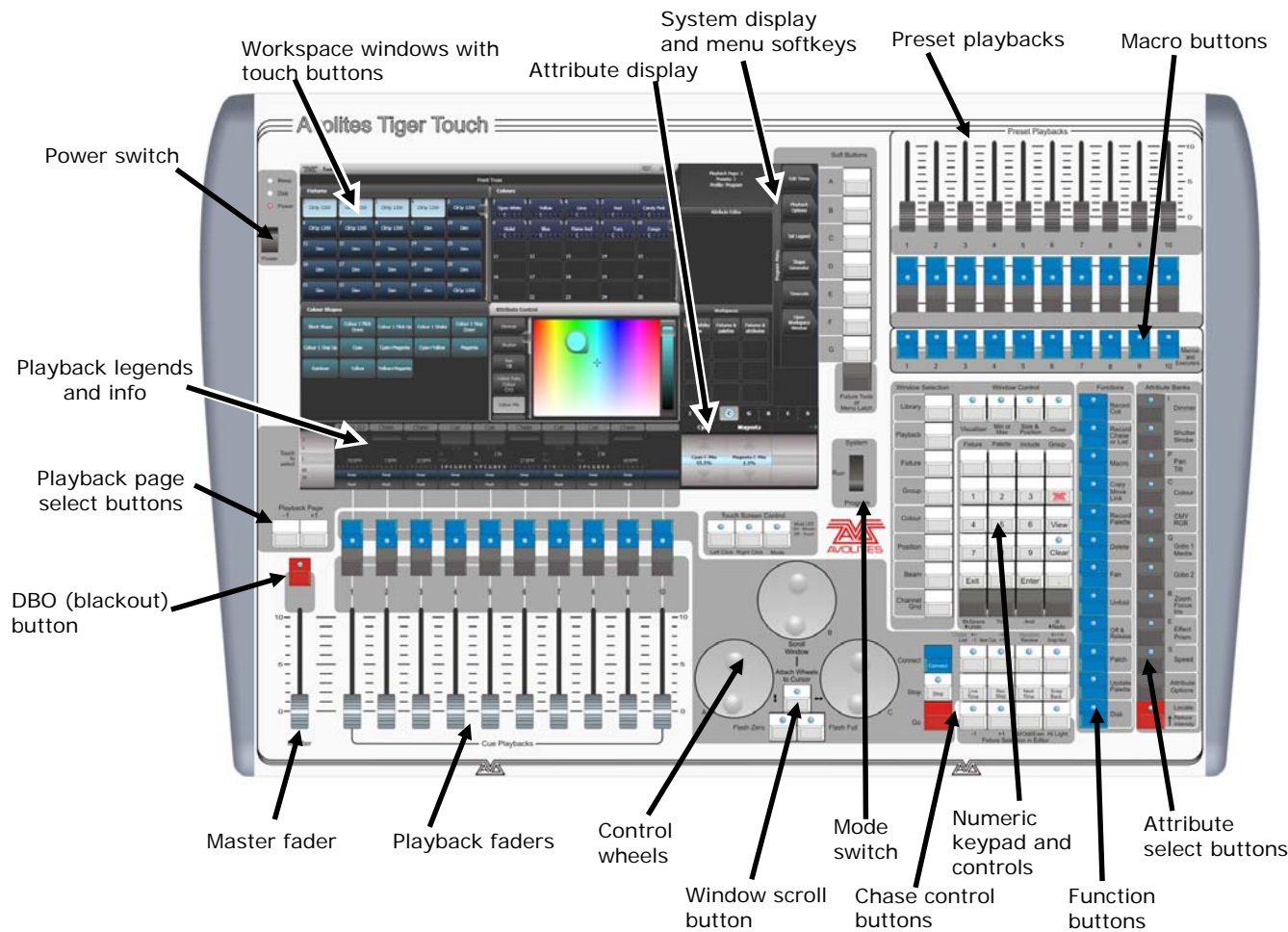

The main controls

The **Workspace windows** on the touch screen contain touch buttons for fixtures, palettes, groups, playbacks, macros and more. You can also set fixture attributes and show information windows.

The **System display and menu** area of the touch screen is the nerve centre of the console and shows you what is going on. This part of the display shows various screens of information depending on what you are currently doing.

The **Menu Softkeys** (labelled A – G) are used to select control options. The display next to the buttons shows what each one will do. The options for each key change depending on what the console is doing. Softkey commands are shown in the manual with square brackets like this: [Edit Times]

The **Preset Playbacks** are used to store and play back cues or chases that you need frequently. These playbacks are not changed by the page select buttons, but you can assign macro buttons to change pages (see section 7.1.2 on page 155).

The **Macro Buttons** store frequently used sequences of keypresses which can be replayed with a single button press. Playbacks can also be stored here.

The **Master fader** controls the overall output of the console. You will normally have this set at Full. The **DBO button** allows you to blackout the whole console.

The **Playback faders** are used to store and play back cues or chases. The **Page Select buttons** let you change to a different page of playbacks. The touch screen above the faders shows information about each playback.

The **Mode switch** selects Programming, Run or System modes of operation.

The **Control wheels** are used to set control values (attributes) for the fixtures, and to set chase speeds and fades. The touch screen above the wheels shows information about the attributes being controlled. Press the **Window Scroll Button** to switch the wheels into scroll mode – this is used to move a selection box around the screen when editing.

The **Numeric keypad** and other control buttons are used to enter values and change controls on the console.

The blue **Function buttons** are used to carry out functions such as storing cues, copying, saving to disk, etc. These buttons have lights on to indicate when they are active.

The **Attribute select buttons** are used to select which attributes of a fixture (e.g. colour, gobo, pan, focus) are going to be controlled using the Control wheels. The buttons have lights on to show you which attributes are active. The bottom (red) button allows you to locate fixtures, which sets them to a known start position while programming.

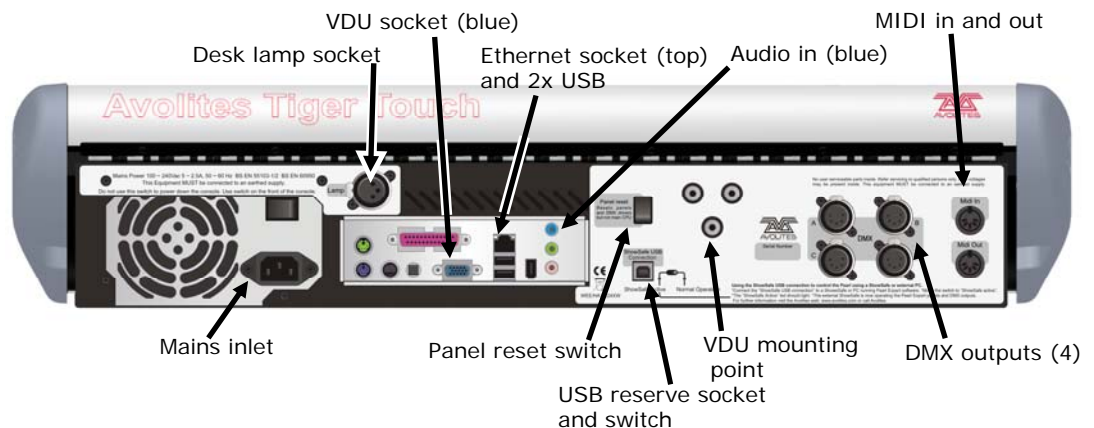

The back panel

All the connections required for the console are found on the back panel. Most are self-explanatory.

The Panel reset switch may be pressed to restart the front panel electronics if something odd happens with the switches and faders. The main board will continue running but the DMX output will be interrupted until the restart is completed.

The USB reserve socket and switches are for future expansion. The switch should be set to 'Normal operation'.

2.2 Connecting up

2.2.1 Cautions



Radio transmitters may affect the operation of the console and we recommend that they are not placed on, above or behind the console. If you are wearing one it is best placed in a back pocket or behind you when attached to a belt.

2.2.2 Connecting mains power

You can safely connect the Tiger Touch to any voltage from 80 to 260V.

The console may be fitted with an internal UPS (uninterruptible power supply) module, available as an upgrade from Avolites. If an internal UPS is not fitted, we recommend that you run the console through an external UPS (available from computer suppliers). If the console unexpectedly loses power, you can lose data (up to the last Autosave) and the console may want to check its disks on startup which can cause delays. The UPS will protect you from most power problems and give you chance to shut down the console normally.

In case of power loss, the toolbar at the top of the screen will turn orange and display how long you've got before the console shuts down.



When the UPS battery runs low and the console is about to shut down, the toolbar turns red.

2.2.3 Starting up and shutting down

The console runs a Windows-based operating system internally, so you need to make sure it is shut down properly rather than just turning off its power.

Start up the console by pressing and releasing the Power switch at the left hand side of the touch screen. The console display should come alive. The console takes about 1 min 30 seconds to start up.

Shut down the console by pressing and releasing the Power switch again. The console will perform a controlled shutdown. Wait until the Power light has gone off (about 30 seconds) before you disconnect power from the console.

To carry out a **Forced Shutdown** of the console, if the normal shut down does not work, hold down the power switch for 5 seconds. You will lose any changes to your show since the last save.



Do not use the power switch on the rear of the console to switch off the console as this would not close down the console properly and you will lose any changes to your show.

2.2.4 Titan Healthcheck

When the console starts up, it runs a small utility called Titan Healthcheck which checks the file system and the installed firmware and software. If any problems are found, a warning screen is displayed which offers the option to fix the problems.

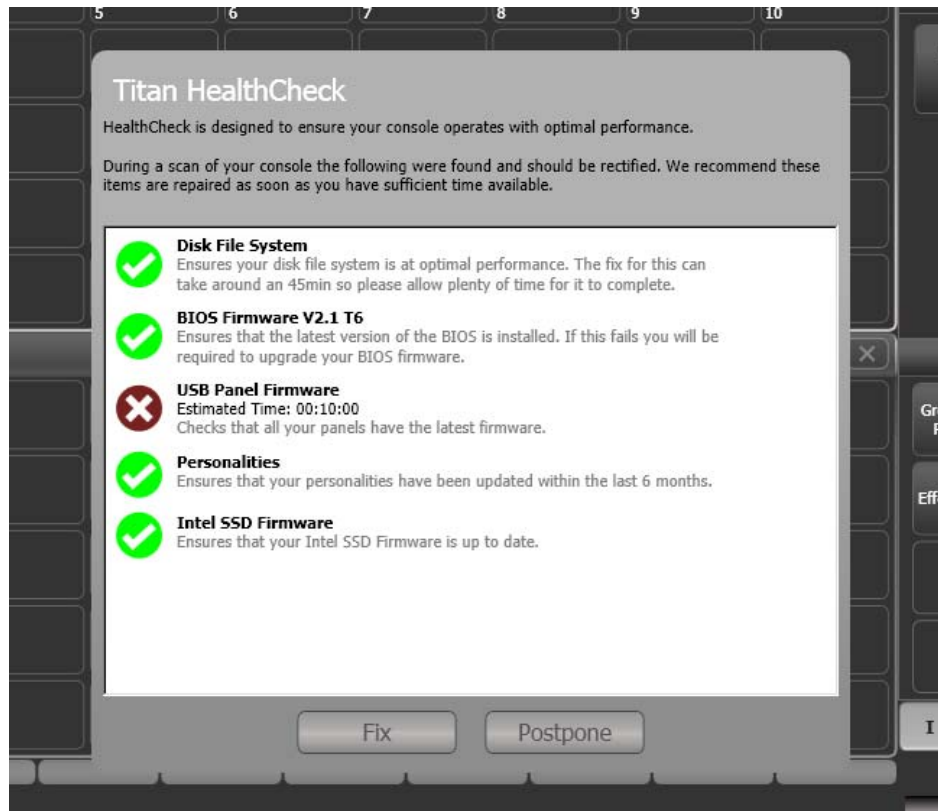

Only run fixes if you have plenty of time as some fixes can take up to an hour to complete.

2.2.5 Connecting DMX lines

The console communicates with lighting fixtures using the DMX512 system. The console itself can output 12 universes of DMX (each 512 control channels). If you need to output more universes, it is recommended to network the console to one or more Avolites TitanNet processing nodes. This off-loads the DMX processing, allowing the console to control up to 64 universes of DMX in total (see section 12.4.1 on page 196 for more details).

The console has 4 DMX outputs on 5-pin XLR for direct connection to fixtures and dimmers, and can send DMX over Ethernet and wireless Ethernet systems to allow connection to remote DMX Ethernet nodes, media servers, and so on.

When you patch a dimmer or fixture you tell the Tiger Touch which of the 12 (or 64 with TitanNet) DMX universes it is on. Each universe can be configured to come out of one or more of the standard DMX

outputs on the back of the console, or over an Ethernet protocol (see section 14 on page 209.)

By default, DMX Lines 1-4 are connected to the four XLRs on the console.

The 5-pin XLR sockets on the console are wired like this:

Pin 1	Earth
Pin 2	Data -
Pin 3	Data +
Pin 4	Not used
Pin 5	Not used

Each DMX line should pass through all the fixtures to be connected on that line one after the other and have a DMX terminator fitted at the end (120 ohm resistor between pins 2 and 3). You should not split the DMX lines using passive splitters (Y-splits) as this can corrupt the data.

2.2.6 Connecting a monitor

You can optionally connect a VGA computer monitor to the console. This gives you extra screen space for workspace windows which can be handy for showing Visualiser or other information windows.

The external monitor is disabled by default and will show a 'disabled' message. To enable, switch to System mode and select [Display Setup] then press [External Display Disconnected]. The option will change to [External Display Connected] and the display will be enabled.

If you need to change the monitor resolution or settings, touch 'Tools' at the very top of the screen and select 'Control Panel', then 'External Monitor', then select the option to match the resolution of your monitor.

There are more details about setting up an external monitor, including troubleshooting help, on page 225.

2.2.7 Other connections

You can connect an external keyboard and mouse to the console if you don't like the touch keyboard which pops up on the touch screen. If you are using an external non-touch monitor you will need to connect a mouse. You can connect either USB keyboard/mouse or use the green/purple PS/2 connectors on the rear of the console - if using PS/2 devices, plug the devices in before powering up the console.

The console provides MIDI connections which can be used to trigger playbacks or connect MIDI timecode to the console for timecode-controlled cue lists.

You can connect the console to a LAN (local area network) using the RJ45 socket on the rear. This allows you to operate many more universes of DMX using DMX network protocols.

A 3-pin XLR socket for a desk lamp is provided on the rear edge of the console. Suitable lamps are available from Avolites. The lamps are 12 volt, wired from pins 1 (negative) and 2 (positive) of the XLR.

2.3 Using the touch screen and monitor

The heart of the Tiger Touch is its large touch screen.

2.3.1 Workspace windows

The main area of the screen contains the workspace windows. These contain buttons for selecting fixtures, groups, palettes, playbacks and so on. Information windows such as Playback View and the integrated Visualiser application can also appear as a workspace window.

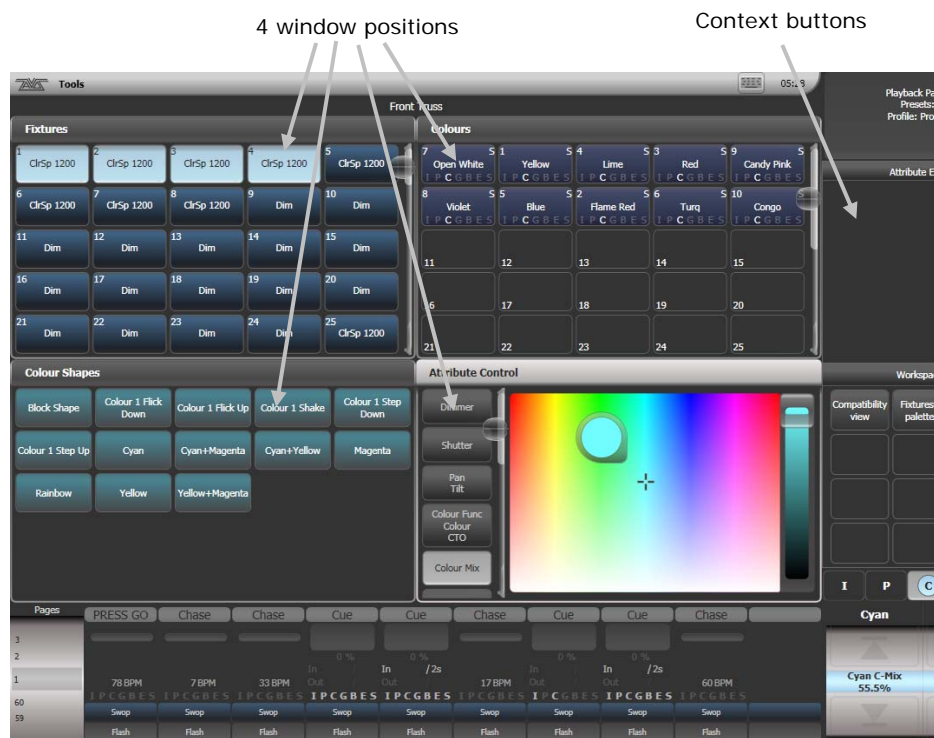

Up to 4 windows can be shown on the screen in a 2x2 grid, but if you need a larger view, you can make a window twice as big, or maximise it to take up the whole screen. You can also move windows to an external screen which can show a further 4 windows. Some possible window sizes/positions are shown below.



Quarter size



Double wide



Double height



Maximised

Some windows have associated control buttons, these are positioned in the 'context buttons' area on the top right of the screen.

Selecting and positioning workspace windows

You select which workspace windows you want to see using the [Open Workspace Window] menu command on the root menu, or by pressing the Window Selection buttons just to the right of the touch screen.

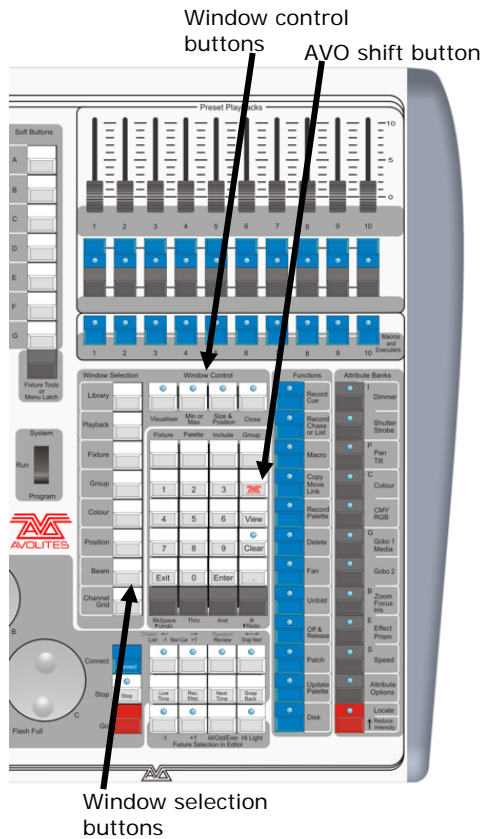

You can also press the View button to access the [Open Workspace Window] option while in another menu.

You can change the positions and sizes of the windows by using the Window Control buttons above the numeric keypad above the numeric keypad. The min/max button swaps the active window between full screen and quarter size. The size/position button moves the active window around the possible positions. You make a window active by clicking/touching its header bar.

You can move the active window to a different monitor by pressing Avo and the Size/Position button, or View then [Window Options] then [Move Screen].

Window shortcuts

Press View then an Attribute Bank button to open the Palette window for that attribute.

Press View then Patch to open the Patch View window.

Press View then a fixture select button to open the Fixture View window showing patch details for that fixture.

Press View then Connect to open the View Cue window.

Press View then Off to open the Active Playbacks window.

Press View then Macro to open the Macro window.

Workspace window options

You can change the window sizes and positions by clicking the small 'i' button in the top right corner of the window. These options also allow you to set the button size and the text size of the window. The Screen options may vary depending on the setup of the console and if you have any external monitors.



Saving workspaces

You can save different workspace setups to the Workspaces touch buttons (to the left of the menu) by pressing View then [Record Workspace], then touching one of the Workspaces buttons. This allows you to reconfigure the workspace at the touch of a button.

Workspaces are saved with the show.

Setting up and recording workspaces is described in more detail in section 12.1 on page 189.

Quick record

Some windows – Groups, Workspaces, Playbacks, and all the Palette windows - have a Quick Record function. Set up what you want to record, then touch or click the button once. The button will light up red with a + sign. At this point you can enter a legend. Touch or click again to store the item.

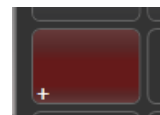

The Quick Record function can be disabled using Key Profiles (see section 12.2.1 on page 192).

Legends and picture legends

All touch buttons can have legends set to remind you what they do. In addition, you can draw picture legends on the buttons. To do this,

select [Set Legend] then press [Picture]. A drawing space will open on the touch screen for you to draw the legend. There is also a library of pictures to choose from including popular gobo designs.



Touch Keyboard

At the right hand end of the toolbar is the keyboard popup button which will open the touch keyboard.

Keyboard button



The touch keyboard can be switched between large and small size using the Max/Min button and you close it using the large X button in the top right hand corner. It can be set to pop up automatically when text input is required, using the Man/Auto button. You can also move it on the screen by touching and dragging the blank area of the keyboard at the top.

The small version of the keyboard (pictured) does not have some of the less frequently used buttons.

Manual/Auto Change size Close



2.3.2 The menu area of the touch screen

The right hand side of the touch screen is used for the operating menu display.

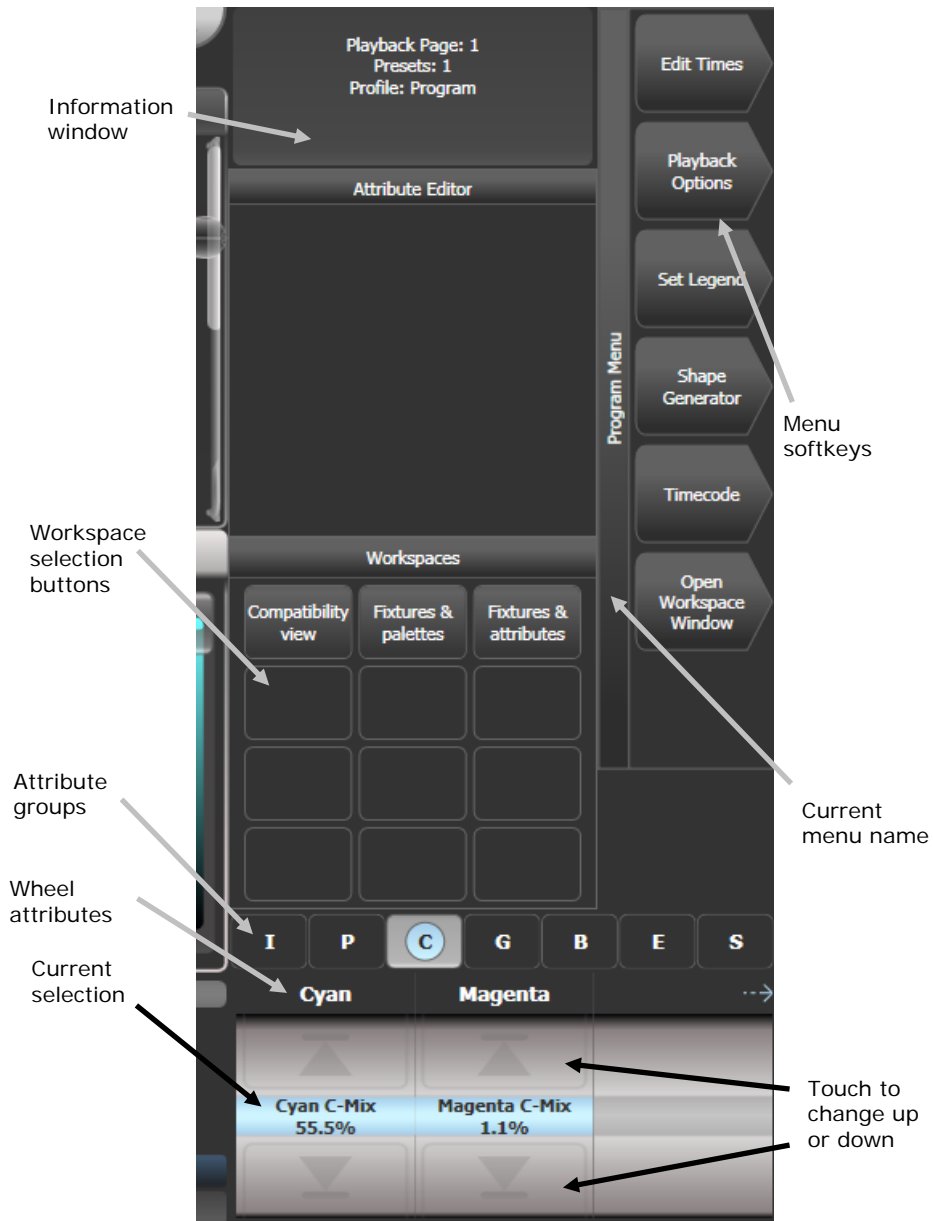

Down the right hand side of the screen, the functions of the A-G menu softkeys are listed. If there are more functions than will fit on one screen, [Previous] and [Next] buttons are provided to page through the functions. You can either press the real button or touch the key on screen.

The vertical bar to the left of the softkeys shows you which menu you are currently in. You can 'latch' the menu (so that you don't have to keep reselecting it) by pressing the Menu Latch button. The menu bar turns red when latched.

The area to the left of this shows instructions to the user and information from the console.

At the bottom of the screen, the current function of the wheels is shown on a simulated roller. If fixture attributes are being set, this shows the possible settings which are available on the fixtures. Above the roller image a legend shows which attributes are being controlled by each wheel and the centre of the roller shows the current attribute. Touch the upper or lower segment of the roller to set the attribute to maximum/minimum.

If a chase is being controlled, information about the chase is shown here.

Above this, the screen shows which attribute group (Intensity, Position, Colour, Gobo, Beam, Effect and Special) is selected (grey box) and which are currently modified (blue circle).

The appearance of the softkeys varies to indicate the type of actions available:

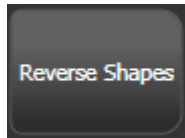

Action button: console will carry out the action shown

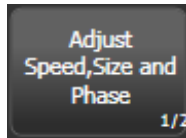

Option button: cycles through a range of options

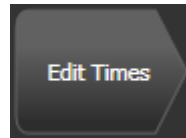

New menu button: jumps to a new menu



Text entry button: press and enter text using the touch keyboard

2.3.3 The toolbar

Across the very top of the screen is the toolbar.



If you click/touch on 'Tools', you will get a menu giving you access to some configuration functions (these options may change slightly depending on the console).

About gives you information about the software version.

Help shows you the online manual.

Control Panel opens a sub-menu allowing changes to monitor settings and to the USB expert console which links the front panel controls to the system. The 'More...' option opens Windows Control Panel allowing you to change the operating system configuration.

Touch Screen Setup (in Control Panel) opens the setup utility which allows you to align touch positions on the screen. See next section.

Usb Expert Console (in Control Panel) sets up the connection between the front panel controls and the software. If you are having problems this can be used to troubleshoot.

Folders opens the file explorer. You might need this when backing up show files or when updating the operating software.

Switch Task allows you to show other programs (may be needed when upgrading software) on the touch screen or move them between screens. Touch the Switch Screen icon to swap the program between different screens. Touch the Centre icon to centre the window on the screen. Touch Close to close the program. The appearance of this window varies depending on the console.



Additional Programs allows you to run some diagnostic programs which might help Avolites Support find problems you're having.

Restart and **Shutdown Software** restarts and closes the Titan software. You would normally only use these when upgrading the software.

2.3.4 The Heads-Up Display (HUD)

The HUD window is shown as one of the workspace windows. Most of the HUD information is now shown in other windows, but if you're used to using it you might like to have it displayed.

Fixtures are highlighted in dark blue if in the programmer and in light blue if selected.

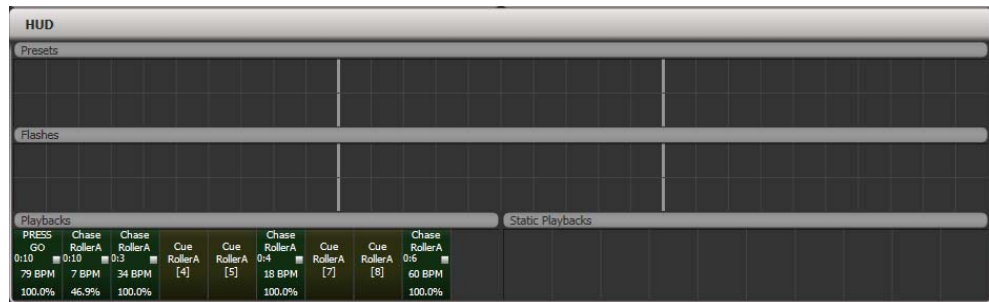

2.3.5 Visualiser

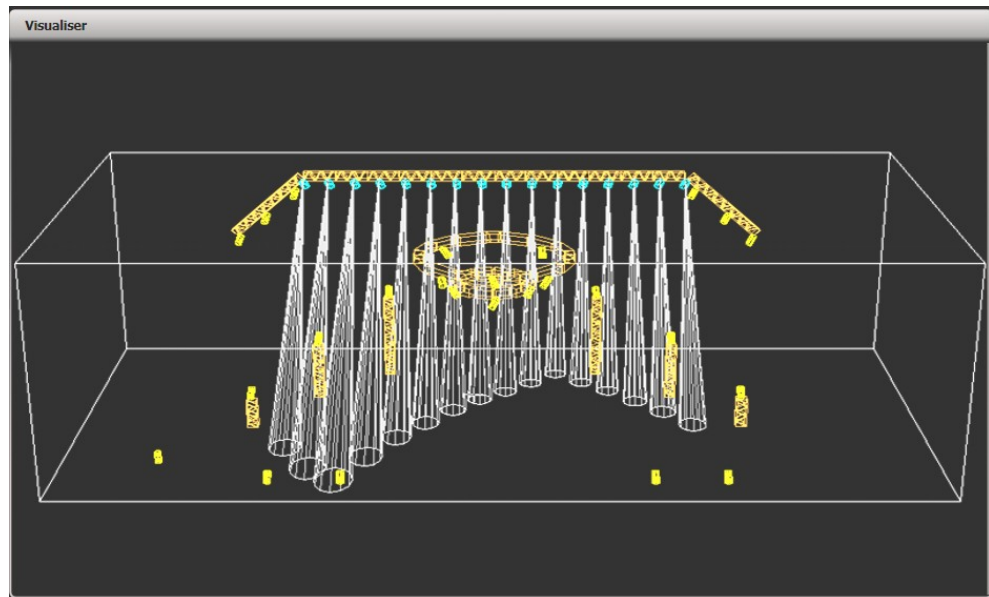

The console runs Avolites Visualiser internally. This allows you to view the output of the console if you can't use the real lights, enabling you to make changes to your show at home or in your hotel. It can also be used in Blind mode for programming during a show.

Visualiser is shown in a workspace window, either on the touch screen or on the external monitor. Press [Window Options] then [Move Screen] on the View menu to move it between the touch screen and external monitor.

Configuration controls for Visualiser are found in the context button area to the left of the menu buttons.

The operation of Visualiser is not covered in this manual, please refer to the Visualiser manual.

Auto Patch

The Auto Patch function automatically creates a Visualiser rig from your show as you patch fixtures. When you start Visualiser, it will open with an automatic representation of your patch.

You will see the fixtures laid out on screen, sorted by handle number.

The Visualiser will start in run mode, with the simulator tab selected so you can start controlling lights immediately.

Multiple dimmers patched to one handle will appear as a single fixture in Visualiser.

Fixture selection

When a fixture is selected on the console, it is highlighted in blue in Visualiser.

2.3.6 Key profiles

The console allows you to change the function of the blue select and grey flash panel buttons. You can also change the way some of the touch keys work. You can save your settings as a Key Profile. Different profiles can be selected for different users or to enhance the operation of the console for a particular use. See section 12.2 on page 192 for details.

2.3.7 Undo/Redo

You can undo and redo up to 20 actions by pressing Avo shift and the Undo or Redo buttons below the numeric keypad (on black Pearl Expert consoles these are the Left arrow (Undo) and Right arrow (Redo) buttons). So for example if you press Clear then wish you hadn't, the Undo function will restore the console state.

You can use undo/redo on the following actions:

- Fixture selection
- Attribute adjustment (eg Pan, Tilt, colour changes)
- Locate
- Clear
- Keypad input
- Applying Palettes
- Group selection
- Off
- Align
- Flip

2.3.8 Key macro buttons

Lighting programming can sometimes require a repeated sequence of button presses. You can record sequences of keypresses and play them back with a single keypress – this is called a macro.

Macros can be stored in the 10 dedicated buttons below the Preset Playbacks, and there is also a Macro button window which can be shown in the workspace. The macro buttons correspond to the first 10 macros in the window.

Macro buttons

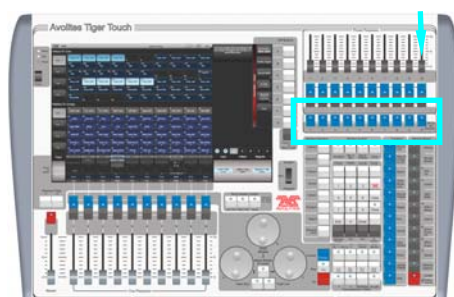

To record a macro:

- 1> Press the Macro button (above keypad)
- 2> Press [Record]
- 3> Press an empty Macro button on the panel, or an empty button in the Macro window on the screen. Recording starts. The Insert/Macro button flashes during recording.
- 4> Press the sequence of buttons you want to record.
- 5> Press Record Macro to finish recording.

To play back the macro, just press or touch the button where you recorded the macro. The macro will repeat all your button presses (but there is no delay or timing between the presses).

2.3.9 Keyboard shortcuts

Many features of the console can be controlled by shortcuts on the keyboard. These are especially useful when using Titan Mobile or Titan Simulator.

The Titan application “captures” the keyboard on start up, meaning that if you try to use other applications at the same time they will not receive keypresses. Pressing Break on the keyboard releases the keyboard for other applications but disables all text entry for Titan including the shortcut keys; changing menus will reconnect the keyboard to Titan.

F1	Move to other screen	Ctrl X	Cut text
F2	Activate window	Ctrl C	Copy text
F3	Minimise/Maximise	Ctrl V	Paste text
Shift F3	Next window	Ctrl A	Select all text
F4	Size/Position	Ctrl Z	Undo
Shift F4	Move to other screen	Ctrl Y	Redo
F5	Close window	Alt C	Clear
Shift F5	Close all windows	Alt R	Record menu
F6	Open Playbacks window	Alt A	Toggle Avo (shift) menu
F7	Open Fixtures window	Alt L	Locate
F8	Open Groups window	Alt P	Patch
F9	Open Colours window	Alt ↑ D	Disk menu
F10	Open Positions window	Alt ↑ S	System mode
F11	Gobos/Beams window	Alt V	Open/View menu
F12	Open Channel Grid	Alt G	Go
Esc	Exit menu	Alt D	Delete
Enter	Enter	Alt ↑ C	Copy
Alt 1	Softkey A	Alt M	Move
Alt 2	Softkey B	Alt U	Unfold
Alt 3	Softkey C	Alt I	Include

Alt 4	Softkey D	Alt ↑ R	Release
Alt 5	Softkey E	Alt S	Shape
Alt 6	Softkey F	Alt T	Fixture Tools/ML Menu
Alt 7	Softkey G	Alt B	Blind
Alt ↑ F	Fixture	Alt O	Off
Alt ↑ P	Palette	Alt F	Fan
Alt ↑ M	Macro	Alt ↑ O	Attribute options
Alt ↑ G	Group	Alt ↑ L	Latch menu
/ (num)	Thro	Alt ←	Previous fixture
* (num)	@	Alt →	Next fixture
- (num)	Not	Alt ↑	All
+ (num)	And	Alt ↓	Highlight

↑ means shift

(num) means on the numeric keypad

2.3.10 Locking the console

You can lock the console controls to prevent people fiddling with it while you're not looking. Hold down Avo and press [Lock], then type a password (numbers or letters). To unlock, enter the password again, or restarting the console will also unlock it.

While the console is locked, all functions are disabled except the DMX outputs and currently running playbacks.

2.4 Titan Simulator

Need to pre-program or tweak your show before you get to the venue? No problem, just run the Titan Simulator on your PC. You can then load your show and simulate any of the Titan consoles, using an on-screen "virtual panel".

You can also use the Titan One software without the Titan One dongle as a simulator for pre-programming.



2.4.1 Installing Titan Simulator

You will need a user account with Administrator privileges to install or run Titan Simulator.



From v7, Windows XP and Vista are no longer supported by Titan software. Your PC must be running Windows 7 or Windows 8.

Simply download and run the installer from the Avolites Download website. The first time you run Simulator you will need to license the software with the Avolites website. For this you will need an account set up on the Download site, which you should go and create now if you don't already have one.

To license the software, start Titan Simulator and choose Internet Activation (the software will ask you for your Avolites Download user name and password and automatically retrieve your license), or Manual Activation (you have to copy and paste the Computer Key into the form on the Titan Simulator webpage).

Once licensed Titan Simulator will run in 'Offline' mode which is shown towards the top right of the screen. In Offline mode the software will function as normal including Visualiser and Art-Net outputs. However periodically random DMX values will be sent down all DMX outputs, please wait for this to stop before continuing programming.

2.4.2 Running Titan Simulator

When you start the simulator you need to select which console you are simulating. The simulator will then open a Virtual Panel, which replicates the controls of your chosen console, and monitor windows for each of the monitor outputs.



The Tiger Touch and Sapphire Touch simulators show the touch screen display separately from the Virtual Panel.

The Virtual Panel works exactly the same as the real panel; to hold a button down so you can press a second button, right click it using the mouse.

2.4.3 Using Virtual Panel with a console

As well as its use with the simulator, you can also run the Virtual Panel on the console. This could be handy to keep things going if you are suffering hardware problems with the real console controls.

To show the Virtual Panel, click the Tools menu on the toolbar, then select Other Programs, then Virtual Panel. The Virtual Panel controls will work in parallel with the real controls.

2.5 Loading and saving shows

You can save any number of different shows on a USB drive or the console's internal hard disk. The console will also autosave the show periodically.



Shows created on the Tiger Touch can be loaded into any other Avolites Titan console, but not to non-Titan consoles as the showfile format is different.

Although your show is safe on the console's internal hard disk, it's a good idea to also save it to a USB pen drive which you can take with you in case something bad happens to the console or if you want to transfer a show to a different console. USB drives are plugged into the rear USB sockets on the console.

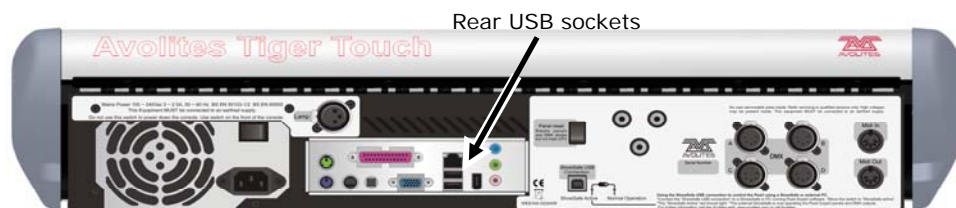

2.5.1 Saving the show

You can save your show at any time either with its current name or with a new name. If you save your show with its current name, a new version of the show will be created. This allows you to go back to previous versions of your show if needed.

To save your current show:

-
- 1> Press the Disk button.
 - 2> Press [Save Show].
 - 3> If you have a USB drive connected, use the softkeys to select whether to save on [Removable Disk] or [Internal hard drive].
 - 4> If this is a new show, enter a name for the show on the keyboard. If this is a new version of an existing show you can enter a tag to help identify the version, which will be shown on the Show Browser screen when you load shows.
 - 5> Press Enter or [Save] (or [Overwrite] if the show already exists). The show will be saved.
 - 6> Press Exit or [OK] to leave Disk mode.
-

- To save the show under a different name, use the [Save As] softkey.
- Pressing the Disk button twice will force the console to save an Autosave version of the file. Autosaves are stored in the same folder as the normal show file.
- A new version of the file will be saved even if you enter the same tag as previously used.

If you save to hard drive, shows are saved in the folder 'D:\Show Files', unless you change this in the User Settings. When using the

Titan Simulator or Titan One, shows are saved to 'Documents\Titan>Show Files'.

2.5.2 Loading a show

The console will automatically reload the last show when it is turned on.

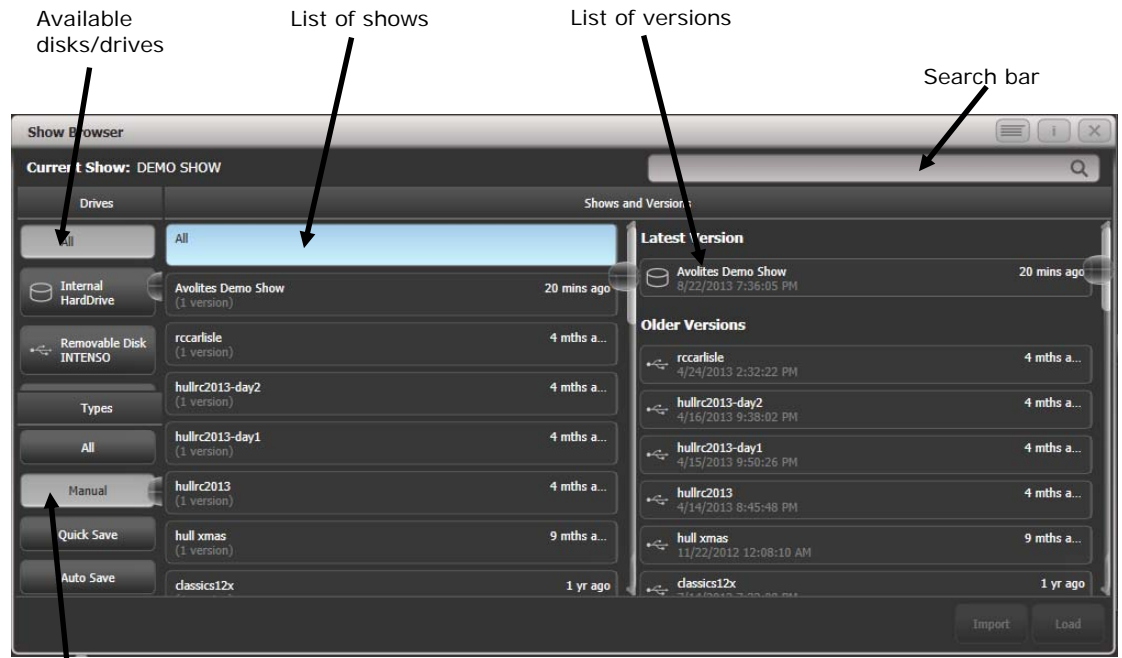

Filter list of shows

Press the Disk button then [Load Show] to load in a new show. The Show Browser window will appear.

On the top left you can select which drive is used, or show files on all drives. On the bottom left you can filter the list of shows to see all shows, or just manual saves, quick saves or autosave files. On the right you can see different versions of the showfile; this allows you to reload an earlier version if you need to.

You can also load shows from the softkeys:

- 1> Press the Disk button.
- 2> Press [Load Show].
- 3> If you have a USB drive connected, select which drive you want to load from.
- 4> Available shows are listed on the softkeys; press the key to load the show (the F and G keys show more pages). If you type the first few letters of the show name on the touch keyboard, the list will only include shows starting with those letters, which can make it easier to locate the show you want.
- 5> If there are multiple versions of the show stored on the disk, select the one you want.
- 6> Press Load Show. The console will show a loading screen as the different elements of the show load.
- 7> When the show has loaded the normal operating screen will reappear.

When loading a show you have the option to keep the existing DMX settings of the console, or to load the settings stored in the showfile. The DMX settings determine how the XLR sockets on the back of the console are used and how DMX is sent over the network using TitanNet.

You can save any number of different shows on the Tiger Touch's internal hard disk.

2.5.3 Importing parts of other shows

If you are doing a show which is similar to a previous one, you might want to import parts of the previous showfile, for example you might want the palettes for some Robe Robins from another show, but not the other fixtures. This is where the Import Show function comes in handy.

For Import Show to work, you need to map fixtures from your imported file to fixtures in the current show so that Titan knows where to import the programming to.

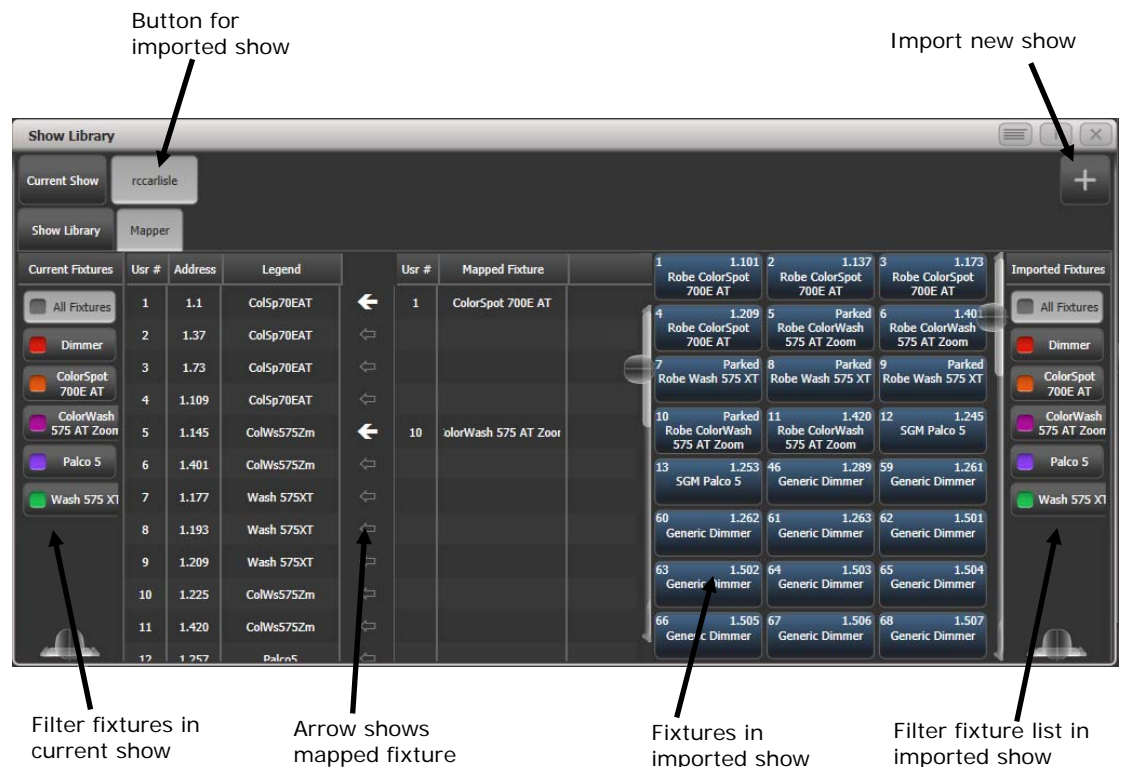

You can then select items from the imported show and store them onto workspace or panel buttons in your current show.

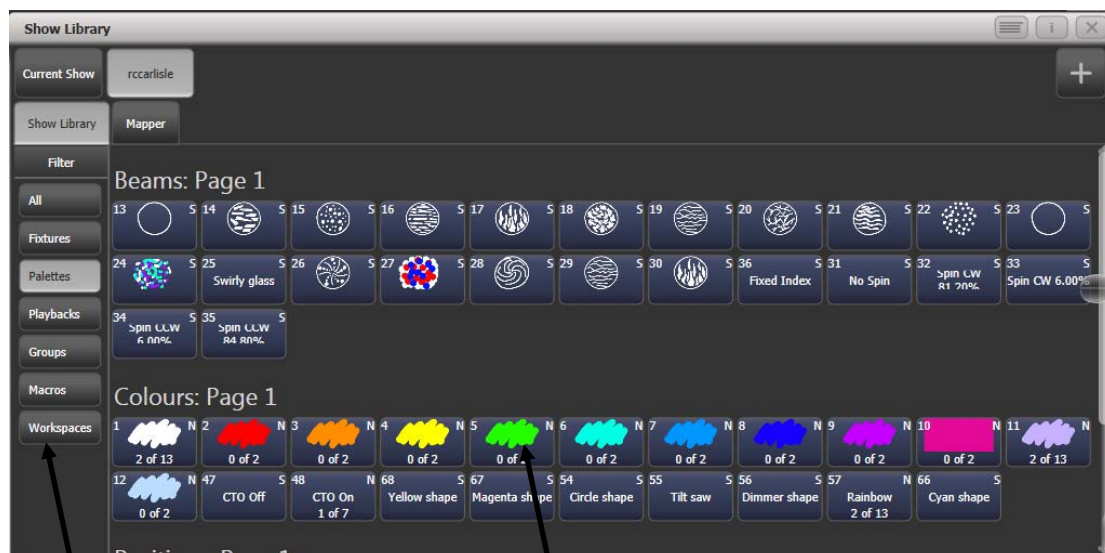

Filter display of
items in show

The items which
can be imported

- 1> Press the Disk button.
- 2> Press [Import Show] (The plus button at the top right of the Show Library window also opens this menu).
- 3> The Show Browser window opens. Select the show you want to import from and press [Load Show].
- 4> The Show Library window will now open. Your current show and the imported show will appear as buttons at the top of the show browser. You can import items from more than one show at once by repeating steps 1-3.
- 5> Click on the Mapper tab, and select your imported show.
- 6> Select a fixture in your imported show, then click the arrow beside the fixture it maps to in the current show. To remove a mapping, click the [Clear Fixture Mapping] context button.
- 7> When you have mapped all fixtures you want to import data from, click on the Show Library tab.
- 8> Select the items you want to import (single or multiple). Use the buttons on the left to select Palettes, Groups etc.
- 9> Select handle(s) where you want to store the imported items.
- 10> When you have imported all the items you want, press Exit.

- You can filter fixture types to make the mapping easier using the buttons on the left and right sides of the show browser.
- You can directly import shows without using the Disk menu by clicking the Plus button at the top right of the Show Browser.

2.5.4 Autosave

The console will automatically save your show to its internal hard disk when you shut it down. It will also autosave the show every 30 minutes in case the console loses power.

You can disable Autosave or alter the time between saves using option [Auto Save] on the Disk menu (selected using the blue Disk button). You can reload Autosave files using the Show Browser.



We recommend that you have autosave enabled while programming in case the power fails, but disable it while running a show as it can cause the console to pause slightly at inconvenient moments.

2.5.5 Backing up existing show files to USB pen drive

If you just want to save a copy of your current show, you can use the normal save function to save it to the USB drive instead of the hard drive.

To copy an existing show file on the hard disk to a USB drive, first ensure your current show is saved, then use the Disk functions to load the existing show from hard disk, then save it to the USB drive. Alternatively you can use the Folders command on the Tools menu.

2.6 Clearing the console

When you start a new show on the Tiger Touch it is usually a good idea to clear the console. All programming and patching is deleted, but user options are not changed.

-
- 1> *Press the Disk button.*
 - 2> *Press [New Show].*
 - 3> *Press [OK] to confirm.*
 - 4> *Press Exit to leave Disk mode.*
-

- When starting a new show you have the option to keep existing DMX settings. This preserves the DMX/TitanNet configuration of the console which determines how the XLR sockets on the back of the console are used and how DMX is sent over the network.
- There is also an option [Wipe] in the System menu (when the console is in System mode) which has the same function, and is located in the same place as on other Avolites consoles.

2.7 Creating reports

When preparing a show it is often useful to create a report of how the show is patched or programmed on the console, for example to give to a crew when pre-rigging fixtures, or just for your records.

Reports can be created in HTML, PDF, CSV or XML formats for the following:

- Fixtures
- Memory (Cues)
- Chases
- Cue Lists
- Palettes
- Groups

To generate reports:

-
- 1> *Press the Disk button.*
-

- 2> *Press [Reports].*
 - 3> *Select the item(s) you want to include in the report*
 - 4> *Select the format in which you want to output the report*
 - 5> *Select the drive where you want to save the report*
-

Reports are output to the Documents/Titan/Reports folder. When the report is complete, Titan will open the folder where the report is stored so you can see where it went.

3. Patching

Patching is the process where you tell the Tiger Touch

- What type of lighting units you have connected to it
- What DMX addresses they are operating at
- Which DMX line (universe) each unit is connected to (there are 64 lines, but the console itself can only output 12; further lines can be controlled using networked DMX processors over TitanNet)
- Which buttons on the console you want to use to access them (either physical buttons or touch buttons)
- Particular option settings for each fixture.



Before you start rigging, you can use the console to work out the DMX addresses for the fixtures in your rig. Patch them on the console (or simulator), then press View, Patch to show the Patch View window. This will use the DMX channels as efficiently as possible without leaving any gaps.

By default, DMX lines 1-4 are linked to the 4 XLR outputs on the console. If you want to change this or use other lines, go to the DMX Settings window in System mode – see section 12.3.6 on page 196 .

3.1 Patching new fixtures or dimmers

3.1.1 Fixture select buttons and handles

To control intelligent fixtures or dimmer channels, they must be patched to a fixture button in the Fixtures workspace window.

If the Fixtures window is not shown, press the Fixtures button to the right of the screen to show it, or press View then [Show workspace window] then [Fixtures].



Fixture buttons can be shown either in pages with Page buttons, or you can use the scroll bar on the right to show different pages. Use the [Pages Show/Hide] button on the right of the screen to select

between page buttons and scrolling mode. You can change the fixture page at any time.

You can allocate fixtures and dimmers to Groups, which allows you to quickly select a set of fixtures with one button. Groups are described in the next chapter.

Once you have patched fixtures or dimmers, the Patch View screen shows you an overview of what is patched where and lets you edit the patch. See section 3.2.1 on page 48.

3.1.2 Patching dimmers

Each fixture button can control single or multiple dimmer channels. You allocate a button using the Patch menu (described below) or the Patch View window (see section 3.2.1).

- 1> Press Patch (one of the blue function buttons bottom right), then [Dimmers].
- 2> [DMX Line=] shows you which of the DMX output lines you are patching onto. Enter a new number to change the line. [Address =] shows the DMX address about to be patched. You can change this by typing in the new address on the numeric keypad and pressing Enter.



- 3> To patch a single dimmer, press a Fixture Select button. To patch a sequence of dimmers each to its own button, press [Quantity] and set the number of dimmers then press the first select button. Alternatively, run your finger across the buttons on the screen. The range of dimmers will be patched to sequential DMX addresses.
- 4> The onscreen Select buttons turn dark blue and show fixture details when they are patched.
- 5> Repeat from step 2 for other dimmers.

- When setting the DMX address using [Address=], you can set the DMX line (universe) as well by entering {line}.{DMX}, for example 2.56 will set DMX address 56 on DMX line 2.
- To see how DMX channels are patched, press View (next to the numeric keypad) then Patch to show the Patch View window.
- [User Number = xx] allows you to set a user-defined number for each dimmer or fixture patched, to help you identify them later. You can also edit the User Number from the Repatch Fixture menu.

- You can patch multiple dimmer channels to a single handle. This can be useful if, for example, you want to control all the lights for one area together. To do this, just press the same Fixture Select button again when patching the new dimmer channel. You can tell the dimmer channel has patched OK because the DMX address will increase by 1.
- If you need to remove a dimmer from multiple dimmers on a single handle without losing programming, make a copy of the handle then repatch the copy to the individual dimmer address.

3.1.3 Patching moving light fixtures

Moving light fixtures are more complicated to patch than dimmers because they have more attributes to control, such as pan, tilt and colour, whereas a dimmer channel just has intensity.

Avolites consoles use a “personality” system to control fixtures. This means you don’t have to know how each fixture works, you just tell the Tiger Touch what you want to do and it will send the right control commands. The console has built-in personalities for most types of fixture, which tell it what attributes are available and how to control them. If the console does not have the personality for your fixture, you can download further personalities from the Avolites website, create your own using the Personality Builder application installed on the console, or Avolites can create one for you. See section 13 on page 205 for details of how to find personalities.

You can patch either using the Patch menu (described below) or the Patch View window (see section 3.2.1).

- 1> Press Patch (one of the blue function buttons bottom right).
- 2> Press [Fixtures].

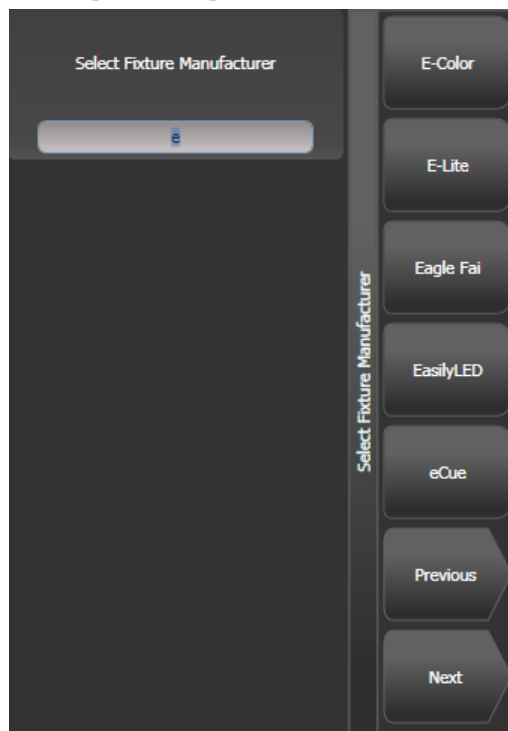

- 3> Select the correct fixture manufacturer from the softkeys ([Previous] and [Next] page through the list of manufacturers).

Or use Quick Search and type the first few letters of the manufacturer's name on the keyboard to find the one you want.

- 4> Select correct fixture from the softkeys (F and G show other pages). You can use Quick Search here as well.
- 5> Select the correct fixture operating mode from the softkeys.
- 6> [Address =] shows the first free DMX address. Type the new address on the numeric keypad if you want a different one. [DMX line=xx] lets you patch to a different DMX line, or you can enter the address as [line].[address], e.g. 2.45 would set address 45 on line 2.

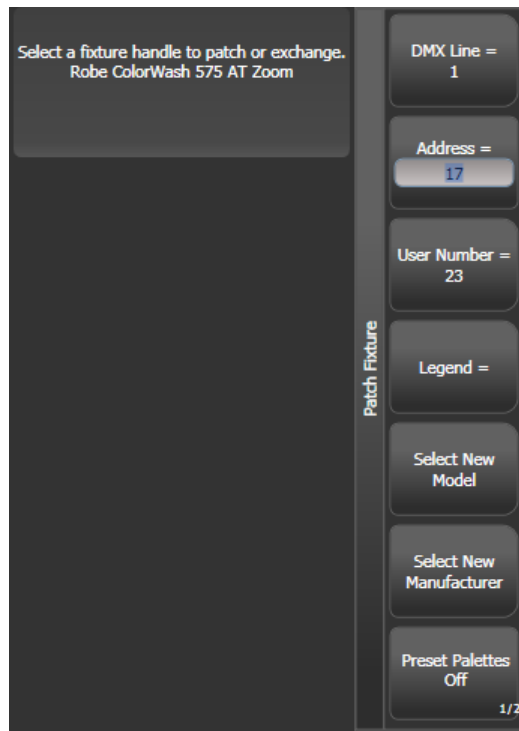

- 7> Press a Fixture Select button to patch the selected fixture.
- 8> The onscreen Select button turns dark blue and shows fixture details when it is patched.
- 9> Repeat from 7 to patch more of the same fixture type. The DMX address automatically updates so you can just keep patching by pressing Select buttons.

- You can patch a number of fixtures in one go using the [Quantity] button, or by running your finger across the buttons on the screen, in the same way as for dimmers.
- [Options], [Offset] allows you to leave gaps in the DMX channels between fixtures when patching multiple fixtures, which is useful if you are planning a show which may involve exchanging fixtures. The Offset number is the size of the block which will be allocated to the fixture, for example if you want to allow 32 channels for each fixture you would set Offset to 32.
- You cannot patch more than one fixture onto a button. If the button is already used, the patch will fail.
- If you are patching a fixture which uses a separate dimmer channel, such as a VL5, you can patch the dimmer channel onto the same handle as the moving light part of the fixture so you can control it all together. This is called a Pending Dimmer (in

the Patch View window this is indicated with a flash symbol behind the user number).

- [Options], [Preset Palettes] sets whether the console will create default colour, gobo and position palettes for the new fixture. These are created in the Position, Colour and Beam workspace windows.
- [Options], [AutoGroups] sets whether the console will automatically create groups from the fixtures you patch. If Enabled, a group is created for all fixtures of the same type, and another if you patch a quantity of fixtures.
- To show the DMX address for fixtures, press View then Patch. To show patch details for a single fixture press View then the fixture select button. On touch buttons the DMX address is displayed on the top right of the button in the format {DMX line}. {Address} (this display can be disabled using the context menu).
- If a patch goes over the capacity of a DMX line, the console will patch at the beginning of the next line. For example if you try to patch a Mac500 at channel 1.510, it will actually be patched at 2.1.

3.1.4 Visualiser Auto Patch

If you want to use Visualiser, start it by pressing the Visualiser button above the numeric keys, or press View then [Open Workspace Window] then [Visualiser]. Visualiser will open in one of the workspace windows with an automatic representation of your patch.

If you have another monitor connected, you can move the Visualiser window to it by pressing View then [Window Options] then [Move Screen], or by holding Avo and pressing Size/Position.

You will see the fixtures laid out on screen in handle number order. You can then use the Visualiser controls to reposition the fixtures if you wish.

3.1.5 Patching fixtures with multiple cells (sub fixtures)

Some fixtures have multiple cells of control within a single fixture (for example an RGB LED batten). To avoid having to patch every cell as a single fixture, you can patch the whole fixture as one “super fixture” and each cell will then appear as a “sub fixture”. This is very useful when laying out fixtures for use with the Pixel Mapper as it allows you to move and rotate the fixture as a single fixture, but keep individual control over the cells.

If you access the fixture using the handle it is patched on, all cells of the fixture will be controlled together. To access the sub fixtures independently, press Unfold then the select button of the fixture. In the Fixtures workspace, the current page of fixtures will be replaced by select buttons for each individual fixture cell. You can also select subfixtures from the numeric keypad. See section 4.1.4 on page 62 for more details of working with fixture cells.

To go back to normal, press Unfold then [Exit Unfold].



The Sub fixtures feature requires an updated personality file. If sub fixtures does not work on your fixture you may need to obtain the latest fixture personality from Avolites.

3.1.6 Patching by RDM

RDM (Remote Device Management) is a system which allows the console to interrogate the lighting rig to find out what's there. It can then patch itself to match the existing DMX addresses. You can also remotely change modes and other settings on the fixture.



Fixtures must be equipped with RDM for this to work; many fixtures are not. Also if you have DMX buffers or splitters in your rig, they must be RDM enabled or they will block the information being sent back to the console.

Press View then Patch to open the Patch View window then select the RDM tab. All devices which support RDM will be listed here. Click the Full Discover context menu button to rescan the rig for RDM devices.

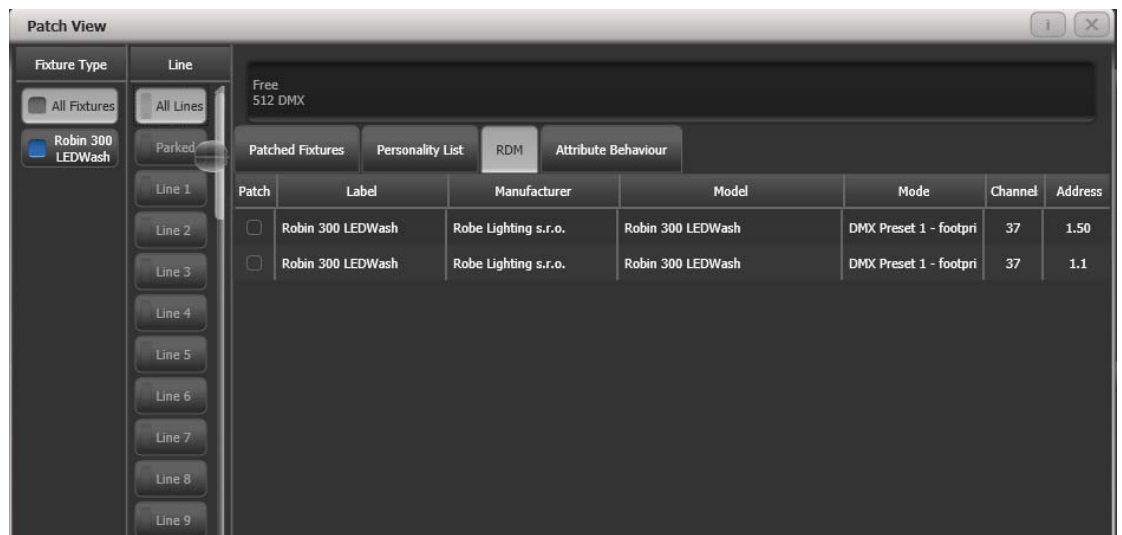

- Select one or more fixtures in the grid and click the Patch context menu button to patch the devices.
- Click on the Mode or Address cells in the grid to change these settings remotely.
- Click on the Identify button (at the right hand end of the screen, you might need to scroll to see it) to turn the fixture on so you can see where it is in the rig.
- Click on the RDM Quick Patch context menu button to automatically patch all RDM devices.

3.1.7 Finding a lost fixture

Sometimes a fixture may be rigged with the wrong DMX address set, or connected to the wrong DMX line.

The Find Fixture function allows you to find the start address of the fixture by scrolling a “locate” state through all possible DMX addresses, avoiding a trip up the rig to look at it. When the fixture responds with its Locate state, you know its DMX address.

- 1> Press Patch, [Fixture] and select the type of fixture you are looking for
- 2> Press [Options], then [Find Fixture] to enable the Find Fixture mode.
- 3> Turn Wheel B to go through all possible DMX addresses. Wheel A sets DMX lines.
- 4> When the fixture responds with its Locate state, you have found the correct DMX address.
- 4> Turn off [Find Fixture] mode and (if not already occupied) patch the fixture. The DMX address/Line will be automatically set to match the Find Fixture settings.

- On consoles with 3 wheels, wheel C (DMX Slot) jumps through DMX addresses using the fixture channel count (for example if a fixture uses 16 channels, it will jump through in 16's).

3.2 Changing the patch

3.2.1 Patch View

The Patch View window gives a full overview of how all the fixtures in your show are patched, and allows you to patch, repatch, legend, renumber, invert, pan/tilt swap, freeze, exchange, park and view fixtures.

To show the Patch View window press View then Patch, or use the Open Workspace Windows menu command.

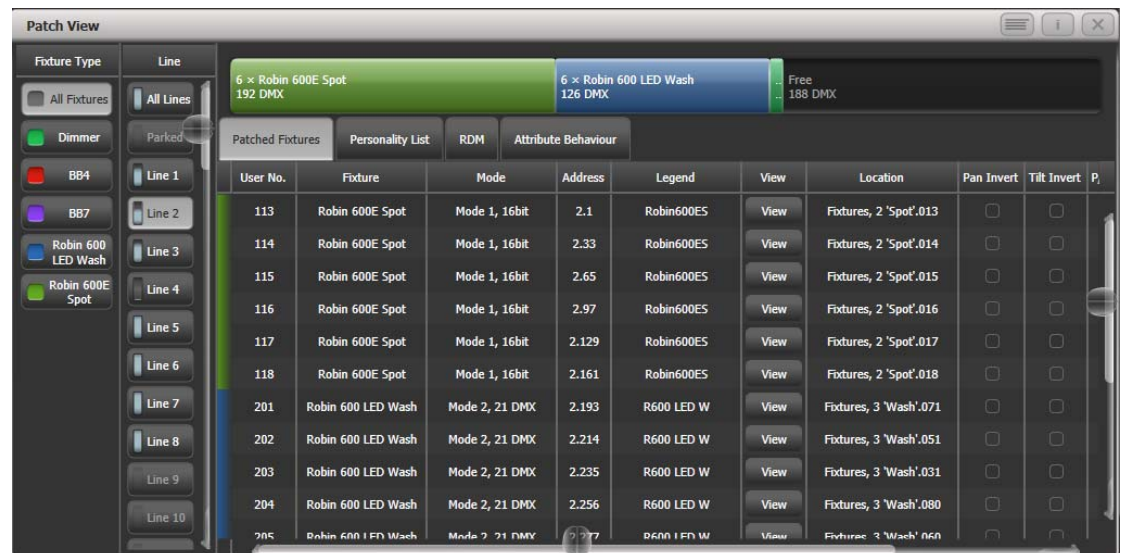

Fixture type: lists the different types of fixture in your show. Each fixture has a unique colour code. Click on these buttons to select all fixtures of the type.

Line: lists the available DMX output lines/universes. The blue bargraph in the button shows how much of the line is used by patched fixtures and how much is free. Click a button to show the details of that line in the right hand side of the window.

The **coloured bar** at the top shows how fixtures are patched on the selected output line, using the unique colour code for each type of fixture. Click on a section of the bar to select those fixtures in the grid below.

The **grid area** shows details for each patched fixture on the selected output line. Some parameters are editable by clicking in the grid, then the softkeys allow you to change the parameter.



You can change parameters for multiple fixtures by dragging a selection box over the grid, or hold the Ctrl button on the keyboard and click on the required fixtures. Then edit the parameter on the softkeys, and use the Set context button to update the selected fixtures.

- You can switch off some of the display columns to make the Patch View simpler. Press the Choose Columns context menu button and then use the options on the softkeys to turn columns on and off.
- You can add notes to each fixture in the Patch View. Click on the Notes field and enter text using the keyboard.

The tabs across the top allow you to switch the window to Personality List (lists all fixtures available on the console), RDM (allows you to patch devices using RDM) and Attribute Behaviour (allows you to set invert, freeze, curve, and limit. See section 3.4.2 and following sections for Attribute Behaviour.

3.2.2 View detailed fixture information

In the Patch View window click on the View button for the fixture you wish to view, or press View followed by a fixture handle. A Fixture View window will open showing details for that fixture, including the personality and mode used to patch, and the individual DMX channel addresses for each attribute. Attributes can be inverted or frozen by clicking on the checkboxes at the right hand side.

Channel Name	Cell	Channel Offsets	Channel Addresses	Inverted	Frozen
Pan	-	1, 2	2.1, 2.2	<input type="checkbox"/>	<input type="checkbox"/>
Tilt	-	3, 4	2.3, 2.4	<input type="checkbox"/>	<input type="checkbox"/>
P/T Speed	-	5	2.5	<input type="checkbox"/>	<input type="checkbox"/>
Control	-	6	2.6	<input type="checkbox"/>	<input type="checkbox"/>
P/T Macro	-	7	2.7	<input type="checkbox"/>	<input type="checkbox"/>
P/T Macro Sod	-	8	2.8	<input type="checkbox"/>	<input type="checkbox"/>

If the fixture address is set using DIP switches, the console can show you how to set the switches by clicking on the DIP Switches tab.

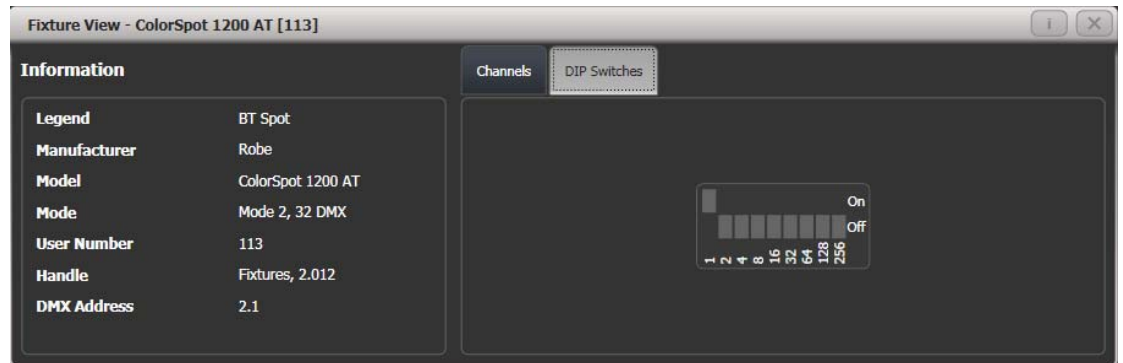

There is also a Personality tab (not shown in the pictures) which shows history information about the personality file for the fixture. This can be useful for checking the version of the personality file.

3.2.3 Changing DMX address using Patch menu

As well as using the Patch View screen, you can use the Patch menu to re-patch a fixture to a different DMX address or a different DMX output line. All programming is kept.

- 1> Press Patch (if you're not already in Patch mode).
- 2> Press [Repatch Fixtures].
- 3> Press the Select button of the fixture you want to change.
- 4> To change DMX press [Address], type the new address and press enter. If this address is already in use, a warning icon will be shown.



- 5> To change the DMX output line, press [DMX Line=x] and enter a new output line number 1-12.
 - 6> Press Enter or [Repatch] to confirm the change.
 - 7> Repeat from step 3 if you want to change other fixtures.
- You can "Park" the fixture using [Park]. This removes the fixture from the DMX output map, but all programming is retained.
 - If the new DMX address already has another fixture or dimmer patched on it, the console will warn you (unless this is disabled in User Options, see section 12.3.3 on page 194). You can either press [Select another DMX address] to abort the change or [Park Conflicting Fixtures]. All programming for the parked fixture is preserved, but you need to repatch it to a free DMX address using the above procedure before you can use it again. If you press [Always Park Conflicting Fixtures] the console will park this and any future conflicting fixtures without warning you (you can change this option back in the User Settings).

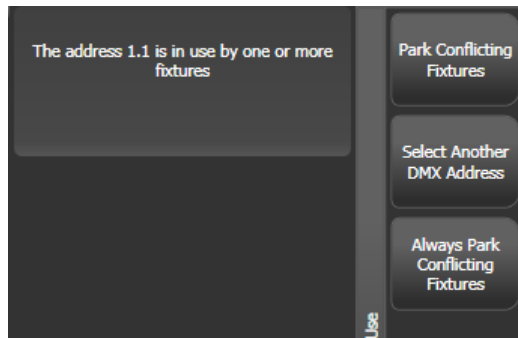

3.2.4 Setting legends

You can set a legend for each fixture or dimmer you've patched which is displayed in the Fixture Select touch button. This can be really useful to help you identify the fixture.

-
- 1> *At the main menu press [Set Legend].*
 - 2> *Press the Select button for the fixture you want to legend.*
 - 3> *Type the legend on the keyboard.*
 - 4> *Press Enter when you have finished.*
-

- You can also choose to have a picture legend using the softkey options.
- You can set the same legend for multiple fixtures by selecting a group of fixtures after pressing [Set Legend].
- You can automatically allocate User Numbers for multiple fixtures by selecting a group of fixtures, then using softkey A on the Set Legend menu. The first fixture will have the User Number you entered, and the other selected fixtures will be given a number increasing by 1 for each fixture.
- You can set a legend for the current page of fixtures using the [Set Legend] function from the main Program menu. The legend is shown on the touch button for the page and on the HUD.

3.2.5 DMX view window

When you're having problems getting fixtures to work it can be useful to see the actual DMX output values coming from the console. Press View, then [Open Workspace Window], then select [DMX].

Line	Index	Line	Address	Control	Output
Line 1	1	1	1	Dimmer	227
Line 2	2	1	2	Dimmer	0
Line 3	3	1	3	Dimmer	196
Line 4	4	1	4	Dimmer	0
Line 5	5	1	5	Dimmer	0
Line 6	6	1	6	Dimmer	0
Line 7	7	1	7	Dimmer	30
Line 8	8	1	8	Dimmer	0
Line 9	9	1	9	Dimmer	0
Line 10	10	1	10	Dimmer	0
Line 11	11	1	11	Dimmer	0
Line 12	12	1	12	Dimmer	0
	13	1	13	Dimmer	0
	14	1	14	Dimmer	0
	15	1	15	Dimmer	0
	16	1	16	Dimmer	0

The buttons on the left let you select the different output lines from the console. Scrolling the window to the right shows more information about each DMX channel.

3.2.6 Fixture Exchange

The Fixture Exchange function enables you to repatch fixtures in your show using alternative fixtures, retaining important elements such as cue times, shapes and legends. This is very useful for touring shows and venues with a high turnover of events.

For example, if you have programmed your show in a venue which has MAC 500s and are moving to a venue with VL6s you can exchange the MAC 500s for VL6s whilst retaining many elements of your show.

Fixture Exchange works best if you use Palettes to create your cues. This allows you to adjust for position differences and so on by reprogramming a few position palettes, rather than having to reprogram every cue. Cues recorded with absolute values will need to be re-recorded, preferably using palettes.

The pan, tilt and dimmer will always be preserved from one fixture type to the next, as will times, shapes and legends for recorded items. Links from the palettes to groups, cues, chases and cue lists will also be preserved, so the show can be easily recreated by updating your palettes as normal.

Fixture exchange also gives you a powerful way to re-use an existing show with new lights, so you can give yourself a programming head start when faced with a new fixture.

- It's a good idea to save your show before performing major changes such as fixture exchange. Should you change your mind or have problems, you will easily be able to return your show to its previous state.

-
- 1> *Enter patch mode by pressing Patch.*
 - 2> *Select the new fixture type you wish to use.*
 - 3> *Touch the select button of the fixture which is to be exchanged.*
 - 4> *The console will warn you that the fixture is in use. Press the [Exchange Fixture] option.*
 - 5> *Repeat from step 3 to exchange other fixtures with the same type of new fixture.*
-



After exchanging fixtures you need to update the palettes which used those fixtures. If you have trouble switching values off in a palette, set new values for all the attributes in the attribute group and re-record the palette. You should then be able to switch off an attribute group as required.

3.2.7 Update personalities

This option allows you to update the personality for a fixture used in your show. Normally a copy of each fixture personality in the show is saved in the showfile, so updating the personality library on the console does not update fixtures which are already patched.

- It's a good idea to save your show before using Update Personalities, then you will be able to undo any changes if you change your mind or have problems.

-
- 1> *Enter patch mode by pressing Patch.*
 - 2> *Press [Update Personality] to update an individual fixture type, or [Update All] to update all patched fixtures to the most recent version in the library.*
 - 3> *If updating individual fixtures, the console shows you a list of personalities used in the show which can be updated.*
 - 4> *If updating individual fixtures, press the personality you want to update.*
-

- The new personality is loaded from the Titan/Personalities folder.

3.3 Copying, moving and deleting fixtures

3.3.1 Copying or moving a patched fixture

Using the Copy/Move/Link button you can make a copy of an existing fixture or move it to a new button. You cannot link fixture buttons. You can copy or move multiple fixtures in one operation.

Move is useful for tidying up the console.

-
- 1> Press the Copy/Move/Link button.
 - 2> Select [Copy] or [Move]. Pressing the Copy button again will also toggle through these options.
 - 3> Press the Select button of the fixture you want to copy/move. You can select multiple fixtures.
 - 4> Press the empty Select button where you want it to go.
-

- The Menu Latch button latches the Copy/Move/Link menu, so you can keep copying or moving things without having to keep pressing the Copy/Move/Link button. Press again to unlatch.
- The [Retain Layout] or [Bunch Up] option is used when copying a group of fixtures with empty handles in the group – you can either keep the empty handles, or bunch up the used handles together. There is also a [Bunch Up With Offset] option which allows you to leave a gap in the DMX channels, if you are running a show where you need to exchange fixtures to ones which use more DMX channels.
- When in Copy mode, option [Copy Legends] can be changed to [Don't copy legends] so that the copied fixtures are given default legends.
- When in Move mode, [Swap Items if Required] will attempt to reposition any existing handles which are in the way of the move. This is useful when rearranging buttons on a page which is nearly full.

3.3.2 Using copied fixtures

Fixture copying is very useful if you need an additional fixture of a type you've already patched and programmed. The new copy will come complete with all the cues and palettes of the original fixture you've copied.

The copied fixture will be "Parked" (have no DMX channel allocated) and you will need to repatch it before you can use it (see section 3.2.1 above).

3.3.3 Deleting a patched fixture

You can delete a fixture or dimmer from a button if you patched it accidentally or if you change your rig and want to use the button for something else.



All programming for the fixture is also deleted. You cannot undo deletion of a fixture or get the programming back by repatching a fixture to the same handle.

If you think you might need the fixtures again later, copy them to an unused fixture page.

-
- 1> Enter Patch mode by pressing the Patch button.
 - 2> Press the Delete button.
 - 3> Press the Select button of the fixture you want to delete.
 - 4> The button will light up red and the console asks for confirmation. Press the Select button again to confirm.
-

- You can delete a range of fixtures in one operation.

3.4 Advanced options

3.4.1 Swap pan and tilt

This allows you to make the pan channel control tilt and the tilt control pan. This can be useful for fixtures rigged in strange orientations.

-
- 1> Press Patch.
 - 2> Press [Edit Fixtures].
 - 3> Press [Swap Pan and Tilt].
 - 4> Select the fixtures to be pan-tilt swapped. Press [Pan and Tilt ...] to select either [Swapped] or [Normal] for the selected fixtures.
 - 5> Press Exit when finished.
-

3.4.2 Invert attributes

This option inverts individual attributes of fixtures. Useful if you have a fixture which pans right when the rest pan left, saving a trip up the rig to set fixture options, but you can invert any attribute.

-
- 1> Press Patch.
 - 2> Press [Edit Fixtures].
 - 3> Press [Invert Attribute].
 - 4> Select fixture(s) to be changed.
 - 5> Select the attribute to invert from the softkeys. The display shows [Inverted] when the attribute is inverted.
 - 6> Press Exit to finish.
-

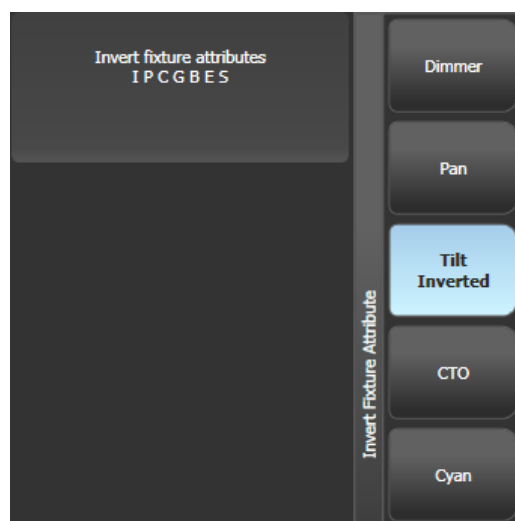

- You can change the invert on multiple fixtures by selecting more than one, but the “Inverted” display will not show if there is a mixture of inverted and non-inverted fixtures in the selection.
- Some attributes cannot be inverted.
- Invert can also be set from the Attribute Behaviour tab of the Patch View window.

3.4.3 Attribute limits

You can set upper and lower limits for any attribute. This can be useful for example to limit the pan/tilt movement of a fixture, or if a fixture has a combined dimmer/strobe function and you only want the dimmer part of the operation.

Attribute limits are set either from the Edit Fixtures menu or using the Attribute Behaviour tab of the Patch View window.

-
- 1> Press Patch.
 - 2> Press [Edit Fixtures].
 - 3> Press [Set Limits].
 - 4> Select the fixtures to be set.
 - 5> Use the softkeys to select which attributes are to be set, then select upper or lower limit.
 - 6> Input a percentage value for the limit value, or press [Set To Current Value]. To remove a limit press [Remove Limit].
 - 7> Press Exit when finished.
-

From the Attribute Behaviour tab, use the context buttons to set Attribute Limits.

It is still possible to put values into the programmer outside the limits. A “limited” watermark will appear on the wheel view behind an attribute when it is being limited.



3.4.4 Fixture / Attribute curves

Curves set how an attribute behaves over the full range of values. They are most often used for dimmer attributes to set the way the dimmer level follows a slider, but can be applied to any attribute.

Curves are set either from the Edit Fixtures menu or using the context buttons on the Attribute Behaviour tab of the Patch View window.

-
- 1> *Press Patch.*
 - 2> *Press [Edit Fixtures].*
 - 3> *Press [Set Curve].*
 - 4> *Select the fixtures to be set.*
 - 5> *Use the softkeys to select which attributes are to be set.*
 - 6> *Use the softkeys to select the type of curve required. The normal setting is Linear.*
 - 7> *Press Exit when finished.*
-

See section 12.5 on page 198 for details of the different curves available.

3.4.5 Freeze fixtures or attributes

This option allows you to freeze individual attributes of a fixture, or to freeze the whole fixture. Attributes or fixtures which are frozen are not affected by playbacks or by the programmer.

-
- 1> *Press Patch.*
 - 2> *Press [Edit Fixtures].*
 - 3> *Press [Freeze Fixture or Attribute].*
 - 4> *Select the fixtures to be frozen/unfrozen.*
 - 5> *Use the softkeys to select which attributes are frozen, or to freeze the whole fixture. Frozen attributes are indicated on the softkey.*
 - 6> *Press Exit when finished.*
-

- Freeze can also be set from the Attribute Behaviour tab of the Patch View window.
- A "Frozen" watermark is shown on the wheel display when an attribute is frozen.

3.4.6 Editing the personality

Sometimes you may find a fixture personality contains errors and needs editing. You can edit personalities directly on the console.

-
- 1> *Press Patch.*
 - 2> *Press [Edit Fixtures].*
 - 3> *Press [Edit Personality].*
 - 4> *The softkeys show a list of all fixture types patched in your show. Select the fixture type to be edited.*
 - 5> *Personality Builder will open allowing you to edit the personality.*
 - 6> *When you save changes, your show will be updated with the edited personality. Your changes are also saved to the fixture library on the console.*
-

- Edited personalities will be saved in the User/Custom personality folder at D:\Personalities (if using the simulator, the folder is at \My Documents\Titan\Personalities). Personalities in this folder are searched and loaded before those in the library and are not overwritten when a new fixture library is installed.
- A separate user guide for Personality Builder is available from the Avolites website.

4. Controlling dimmers and fixtures

When you are programming a show, and sometimes when you are running a show, you need to manually control the fixtures and dimmers to set the intensity, position, colour, etc. To do this you first select the fixtures you want to change using the select buttons, then you set the attributes of those fixtures using the Wheels and Attribute buttons.

You can also set fade/timing information for each attribute of each fixture which is treated as an additional attribute of the fixture.

4.1 Using the select buttons and wheels

4.1.1 Selecting fixtures and dimmers for control

To select the fixtures or dimmer channels that you want to control, you use the Fixture Select buttons to select the fixtures into the Editor. You can select fixtures or dimmers individually, or several at once.



- 1> Press the Select buttons for the fixtures you want. The select button will light up pale blue for selected fixtures or on the preset playback faders the select button will light up (they are also shown in light blue on the HUD).
- 2> To select a range of fixtures, slide your finger across the touch buttons to draw a selection box.

Here are some other things to know:

- Press Locate (at the bottom right of the console) to light up the selected fixtures in open white and move them to a central position. See the next section for more Locate options.
- You can deselect a fixture by pressing the select button again.
- In the system display area of the touch screen, the console will show you which fixtures are currently selected.
- Press Clear (right of numeric keys) to deselect all fixtures and remove all changes from the programmer. See the next section for more Clear options.

- Once you have changed any attribute, pressing a Select button will deselect all fixtures and start the selection process again. All previously selected fixtures (since you last pressed Clear) stay in the programmer. Once a fixture has been edited, the button shows a darker blue (also on the HUD). The picture below shows the first two fixtures selected, with the second three in the programmer and the others unselected.
- You can select fixtures on another page by touching one of the page buttons to the left of the fixture buttons, if you have 'Pages' set to Show (using the context button to the left of the menu buttons). Otherwise you can use the scroll slider to show other pages.



- Using Key Profiles (see section 12.2.1 on page 192) you can set the fixture touch button to latch mode so that it turns the fixture's dimmer channel on (like putting a preset fader to full).

4.1.2 Setting fixtures to a start position (Locate)

The Locate button (the button on the bottom right corner of the console) is used to put the fixture into a known position with light coming out, so that you can start programming it.

A quick press of the button will move all selected fixtures to a central position and reset all the attributes so that you get a white light. However you sometimes might not want to move the fixture, and by holding down the Locate button, you get some more options.

- You can mask off some of the Locate settings (such as only turning the fixture on, but not changing its position or colour) by holding down Locate and pressing [Set Mask to Exclude All]. Then (still holding Locate) turn on the Attributes you want to change using the Attribute Bank buttons down the right hand side. Only the lit attributes will be changed by Locate. Pressing the Attribute Options button (just above Locate) will clear the mask.
- Option [Auto Reset Mask] sets the mask to be automatically reset to include everything each time Locate is pressed, or you can toggle the option to [Remember Mask] which will keep the mask setting you used last time.
- Option [Clear/Don't Clear Located Attributes] sets whether the attributes changed by the Locate function will be saved into any

cues you store. If the option is set to "Clear" then the Located attributes will not be stored in the Programmer unless you modify them using the wheels. This is useful if for example you want to program a cue which sets the position of fixtures, but does not turn them on. The Locate button will light up the fixtures for programming, but the lit state will not be stored in any cues you save.



To quickly locate without changing pan/tilt, hold Locate and press the Pan/Tilt (or Position) button, then release Locate.

To quickly locate pan/tilt only, hold Locate, press Attribute Options (just above Locate), then press Pan/Tilt (or Position), then release Locate.

If you wish to permanently change the locate state of a fixture, you can store a new Locate State. This can be shared (applies to all fixtures of the same type) or individual. To store, set up the desired locate state, then press Record Cue, then Locate. Select [Shared] or [Individual] from the softkeys. Press Record or Locate a second time to confirm.

4.1.3 Clearing selection

The Clear button (on the right of the numeric keypad) is used to remove all changes from the Programmer and deselect all fixtures. A quick press of the Clear button just clears everything, however if you hold down the Clear button, then more options are available.

- You can mask which attributes are to be cleared (for example, leaving the pan/tilt in the programmer but clearing everything else) by holding down Clear and pressing [Set Mask to Clear Nothing]. Then (still holding Clear) turn on the Attributes you want to change using the Attribute Bank buttons down the right hand side, or press [Set Mask] and use the softkeys. Only the lit attributes will be cleared. Pressing the Attribute Options button will clear the mask. The Time mask option allows you to clear or retain the fade/delay times in the programmer for all attributes (clearing individual attributes will also clear times for that attribute, for example setting a P mask will clear position times).
- [Clear Options] opens a submenu showing some further options (described below).
- [Clear All Fixtures/Selected Fixtures] sets whether all fixtures will be cleared from the programmer, or if only currently selected fixtures will be cleared. This is useful if you want to clear specific fixtures.
- [Individual Attributes] allows you to clear individual attributes from the Programmer. When you press the softkey, you are given a list of attributes in the Programmer – press the appropriate softkey to clear that attribute.
- [Clear All Programmers] will clear all programmers that are currently active on the console. This will be used for multi-user programming in future and is currently used to clear values added to the Titan Remote programmer.

The options in the “Clear Options” submenu are:

- [Auto Reset Mask] sets the mask to be automatically reset to clear everything each time Clear is pressed, or you can toggle the option to [Remember Mask] which will keep the mask setting you used last time.
- [Leave/Zero Preset Fader Levels] is used to set whether latched fixtures are cleared (the fixture key profile can be set to “Latch” mode, which turns on the fixture dimmer channel when the fixture button is touched. See section 12.2.1 on page 192.)
- [Freeze current values] sets what happens to LTP (non-intensity) channels you have modified. If set to [Freeze Current Values] the channels remain as you set them. If set to [Release To Playback Values] the channels will go back to how they are set in the current playback. For example: you have an active playback making some lights green, then you select the lights and change them to red. If you press Clear with this option set to [Freeze] then the lights remain red. If the option is [Release] the lights will go back to green.
- [Clear/Maintain Cue Times] - determines whether or not to clear the cue time information from the programmer (this will not affect fixture attribute times in the programmer).

You can use the Channel Grid window to selectively attributes from fixtures. See section 4.2.1 on page 79.

4.1.4 Fixtures with multiple cells/subfixtures

If a fixture has multiple cells of control (for example an RGB LED batten) and its personality supports it, you can select and control the fixture either as a whole or as independent cells. This is particularly useful when using Shapes or the Pixel Mapper.

If you select the fixture using the handle it is patched on, all cells of the fixture will be controlled together.

You can use the buttons which appear at the top of the attribute editor window to select the main fixture, or individual cells for control (use the [Open Workspace Window] softkey to open the Attribute Editor window).



You can also use Unfold to expand the cells onto individual select buttons. In the Fixtures workspace, the current page of fixtures will be replaced by select buttons for each individual fixture cell.

There are two ways to unfold fixture cells:

- Press Unfold then select range of fixtures. The cells will immediately appear on the handles.

- Select fixtures, press Unfold, then press [Selected Fixtures]. This method allows for non-consecutive fixtures to be unfolded.

To go back to normal, press Unfold then [Exit Unfold].

You can also use the numeric keypad to quickly select cells. The syntax is as follows:

.	all sub fixtures of selection	n.	all sub fixtures of fixture n
. THRO .j	sub fixtures 1→j of all selected fixtures	n. THRO	all sub fixtures of fixture n→last consecutive of type n
THRO .j	shorthand for above	n. THRO i	sub fixtures 1→i of fixture n
.m	sub fixture m of all selected fixtures	n. THRO i.j	sub fixtures 1→j of fixtures n→i
.m THRO	sub fixtures m→last of all selected fixtures	n.m	sub fixture m of fixture n
.m THRO .j	sub fixtures m→j of all selected fixtures	n.m THRO	sub fixtures m→last of fixture n
.m THRO j	shorthand for above	n.m THRO i	sub fixtures m→i of fixture n
n THRO i.	all sub fixtures of fixtures n→i	n.m THRO i.	sub fixture m→last of fixtures n→i
n THRO i.j	sub fixture j of fixtures n→i	n.m THRO i.j	sub fixtures m→j of fixtures n→i
n THRO .j	sub fixture 1→j of fixture n	n.m THRO .j	sub fixtures m→j of fixture n

4.1.5 Changing attributes using the wheels

"Attributes" are the functions of the fixture, like pan, tilt, colour, dimmer, etc. You select which attributes you want to modify using the Attribute Bank buttons and set values using the wheels. The attributes available depend on the fixture type. Dimmer channels only have a dimmer attribute.

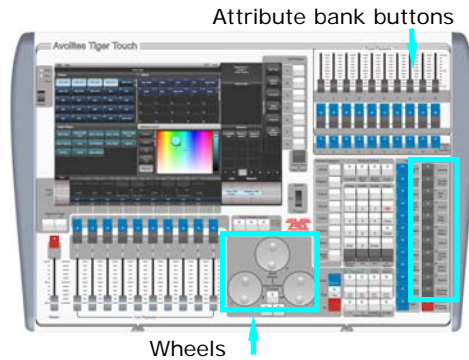

You can also select attributes by touching the IPCGBES buttons on the touch screen, and modify them using the Attributes workspace window; this is described in the next section.

Each attribute button controls several attributes, one on each wheel.

- 1> *With some fixtures selected, press the button for the attribute to be changed*
- 2> *Turn the wheels to set the attribute. The display above the wheels shows which attributes are being controlled, and the settings which are available scroll up and down as you turn the wheels.*

You can also touch the roller image on the screen to change the attributes up or down by one. For continuously variable controls like a dimmer, touching the roller will set the attribute to full or zero.

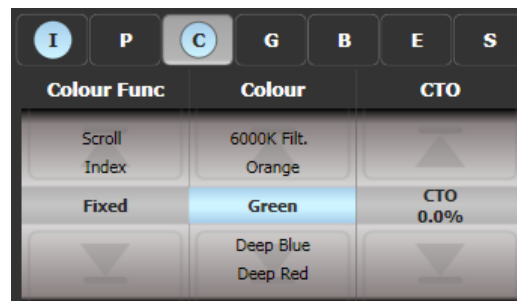

- 3> *Repeat from 1 to change other attributes of the selected fixtures.*

Some other things to know about attributes:

- If an attribute is in the programmer, it is highlighted (as shown with the "Green" setting in the screen picture above). This provides a quick way to see which attributes are in the programmer.
- You can also select the attribute to be changed from the softkeys by pressing the "Attribute Options" button.
- If the display above the wheels does not show the attribute when you press the button, that attribute is not available on the selected fixtures.
- If the wheel display shows a small arrow next to the legends, this means that there are further attributes to control. Press the Attribute button again to toggle through the attributes.

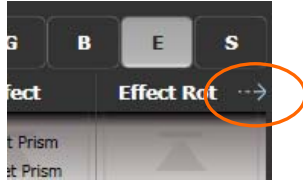

- The wheels operate in an “acceleration” mode. If you spin the wheel fast, the fixture changes in larger steps. If you move the wheel slowly, the fixture moves in its smallest increment.
- Holding down the Avo button while turning a wheel puts the wheel into “Fast” mode. When in this mode, a single rotation of the wheel changes the attribute you are controlling over its full range. For example, if while moving the Pan wheel you hold down Avo the fixture will make a complete pan movement between end stops in one rotation of the wheel.
- Some LED colour mixing fixtures have a Virtual Dimmer function (using the Intensity wheel) which offers intensity control by mastering the RGB levels when the fixture itself does not provide an intensity channel.

4.1.6 Setting attributes using the touch screen

For attributes with fixed values such as gobos and fixed colour wheels, the Attribute Editor window can be easier to work with than the wheels. It also offers a colour picker window for fixtures with RGB or CMY colour mixing.

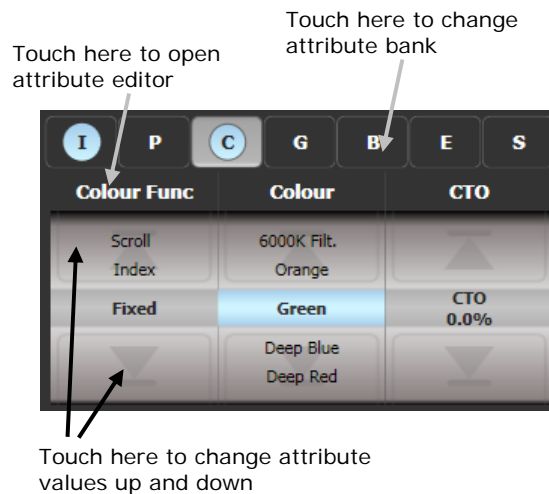

Press View then [Open Workspace Window] then [Attribute Editor] to show it. As a shortcut you can also show it by touching the attribute name text just below the IPCGBES buttons (for example Colour Func in the above picture).

The buttons on the left of the window select the attribute to change.



The rest of the window contains buttons or controls to set the attribute value. For attributes such as gobos and fixed colours, a button is provided for each one, making selection a lot quicker than scrolling through on a wheel.

When you apply an attribute, the button turns blue to show that the attribute is in the programmer. If you touch the button again, the attribute will be removed from the programmer.

Touching the title of each attribute (such as “Colour Func”) expands the attribute to the full window, displaying more buttons.

For fixtures which are capable of colour mixing, you can select a colour from an onscreen palette of colours. The slider on the right hand side sets the intensity.

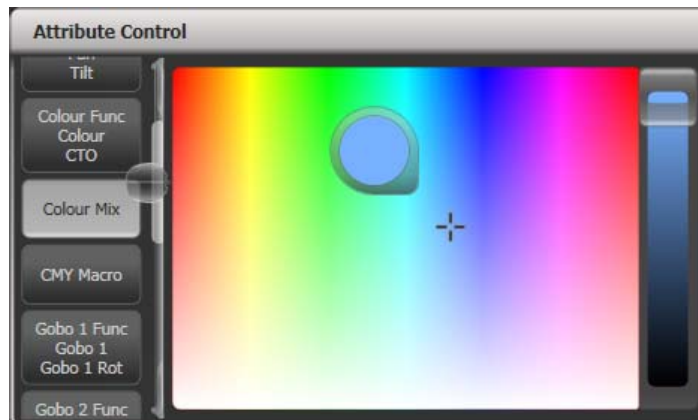

For variable attributes like Dimmer, holding down the button will display a horizontal slider bar. You can then move your finger left or right to change the value.



Active fixtures such as media servers will display a thumbnail of the media clip in the button. The media server must support CIP and be patched as an active fixture.



Fixtures which support keystoneing or blades/shutters can be controlled graphically in the attribute window. Select and drag the corners or sides of the image to control the fixture.



Updated personality files may be required to support the keystone/blade functions.

When the selected fixture has subfixtures, buttons appear at the top of the attribute editor window allowing you to select the main fixture, or individual cells for control.



4.1.7 Setting attributes from the softkeys

You can directly enter a numeric value for the attributes which are live on the wheels. You must be at the main Program menu to do this

(keep pressing Exit until the vertical menu bar shows “Program Menu”).

Type a number on the numeric keypad then press one of the softkeys to set the value to the fixture. The Softkey legend will show what effect your value is going to have (such as [Gobo 5], or [Deep Blue]).



For attributes displayed in percent, such as Dimmer, or Colour Mix, you enter a value from 0-100 to set the percentage output. For attributes where the output is divided up into ranges, such as colour wheels, you enter the index of the range you want. For example to select the 3rd colour (as displayed in the list above the wheel) you would enter 3.

4.1.8 Adjusting attributes with the @ buttons

Pressing the @ button next to a wheel opens the Adjust Attribute Value menu for that attribute. The three buttons between the wheels act as @ buttons.

You can also open this menu by touching the centre of the wheel view for the attribute, or by clicking on the attribute in the Channel Grid window.

The menu gives you the following functions:

- Select Function: gives you shortcuts on the softkeys to the possible settings for the attribute (for dimmers, a range of values is provided).
- Touch/Clear: places the attribute in the programmer or removes the attribute from the programmer
- Locate: locates the attribute (does not place in programmer)
- Release: releases the attribute
- Off: sets the attribute to Off. This temporarily disables the attribute, though its value is stored and can be restored with On.
- On: sets the attribute to On (when merged to a cue or palette, On will restore a value which has previously been set to Off)
- Freeze/Unfreeze: freeze or unfreeze the attribute

4.1.9 Selecting fixtures and dimmers by number (Channel)

In some situations, for example when programming lots of dimmers, it can be easier to type in the dimmer channels you want to program. The Channel menu allows you to do this for dimmers or fixtures. To access the Channel menu, press the Fixture button on the top left of the numeric keypad. You can also simply start typing numbers on the

keypad, when you press Thro, And or @ (functions of the grey buttons at the bottom of the numeric keypad) then the Channel menu will be shown.

Fixtures may be selected by User Number, Handle Number or DMX Address, as set by the option on Softkey A.

For Through, And and @ you can either use the softkeys or the grey buttons at the bottom of the numeric keypad.

When using the Channel menu it is helpful to latch it by pressing the Menu Latch button.

- To select a fixture, type the number and press Enter.
- To select more than one fixture, press the [And] softkey between each number. For example 1 And 2 And 5 Enter will select 1, 2, 5.
- To select a range of fixtures, press [Through]. For example 1 Through 8 Enter will select 1-8.
- To miss out fixtures in a range, use [Not], for example 1 Through 4 Not 3 Enter will select 1, 2, and 4.
- The @ softkey sets a dimmer level to the selected fixtures, for example 1 Through 8 @ 5 Enter will set 1-8 at 50%. (You can choose whether 50% is entered as "5" or "50" in the User Settings – see section 12.3.3 on page 194). When you press @ there are softkey options for Full, Off and +/- (increase or decrease brightness).
- You can work with Groups using the Group button, for example Group 1 And Group 2 Not 5 Enter will select all fixtures in group 1 and group 2 except for fixture 5.
- You can use the Locate button instead of Enter, to select fixtures and locate them. For example 1 Through 4 Locate will select fixtures 1 to 4 and locate them.

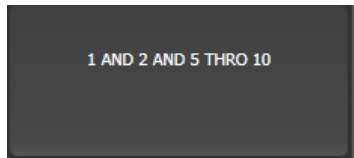

- When entering a command, the command line is shown on the display. You can go back using the grey Back button and you can abandon the line using the grey @ button.
- The AND, THRO and @ functions are also provided on the grey buttons at the bottom of the numeric keypad as printed next to the buttons.

4.1.10 Selecting using a pattern

When programming you will often want to select patterns of fixtures. Rather than having to individually select and deselect fixtures, the Tiger Touch has an easy way of selecting odd then even fixtures in a range of fixtures, or it can, for example, select every 4th fixture.

1> *Select some fixtures.*

- 2> Press the white All button (below the Next Time button to the right of the wheels).
- 3> Select a pattern from the softkeys. Your selection is modified so you will only be controlling, say, the odd fixtures.



- 4> Press the white 'Next' button to change the selection to the next stage of the pattern.
- 5> To end the pattern selection, press All twice.

- For example, if you are programming a chase using 16 fixtures and you want every 4th fixture to do the same thing, you just select the 16 fixtures, then press All, then D [1 in 4]. You will see that the 1st, 5th, 9th and 13th fixtures are now selected, and you can create the look for those fixtures. Then press Next, and the 2nd, 6th, 10th and 14th fixtures will be selected ready for programming. After you have programmed the fourth set of fixtures, the pattern will go back to the first position again, until you press All twice to end.
- You can enter your own patterns using the numeric keypad and softkeys, for example "2" A [In] "6".

4.1.11 Selecting fixtures which are in a palette or playback

To select fixtures which are controlled by a particular palette or playback use the Select If function.

To select fixtures used in a playback or palette, press Fixture, [Select If] then the palette or playback button. (The Fixture button is at the top left of the numeric keypad and may be labelled Channel on older consoles.)

You can also use Select If with the @ and Through buttons on the numeric keypad to select fixtures set to a particular intensity.

- @X: fixtures set to intensity X
- @ Through X: fixtures with intensity 0 – X
- @ X Through: fixtures with intensity X – Full
- @ X Through Y: fixtures with intensity between X and Y
- @@: fixtures with intensity above 0.

Intensity levels may be input as 0-9 or 00-99 depending on the User Setting [Channel Levels Set In] (see section 12.3.3 on page 194).

4.1.12 Attribute groups – IPCGBES-FX

To make life a bit simpler, the console groups together attributes which have similar effects, using the letters IPCGBES-FX.

I-Intensity (dimmer, strobe shutter)

P-Position (pan, tilt)

C-Colour (colour wheel, CMY mixing)

G-Gobo (gobo wheels, gobo rotate, gobo position)

B-Beam (iris, focus, zoom, beam shaper)

E-Effects (prism)

S-Special (motor speeds)

FX-Shapes, Pixel Mapper

These groups are used to select which attributes you want to work with in many of the functions on the console, particularly when you are "masking off" certain attributes from being saved.

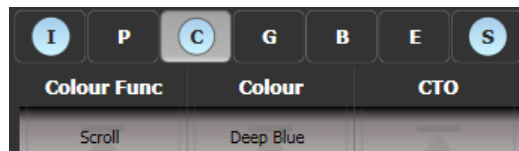

Above the attributes roller on the screen, the console shows you which attribute group you are currently changing (the grey box). The Attribute Group is also highlighted in blue if the programmer contains any of those attributes. For example in the image above we are currently changing Colour attributes, but Intensity and Special attributes have also been modified.

4.1.13 Using fixture groups

You can create groups of fixtures or dimmer channels, which can then be quickly selected together by touching a group button (shown in the Groups window) or typing the group number. You can, for example, make a group for each type of fixture, or group by stage left / stage right, etc.

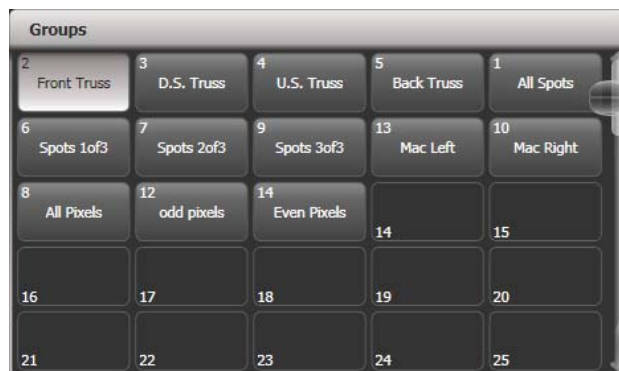

If you assign a group to a handle with a fader, the fader becomes an intensity master for the group. See section 10.1.7 on page 172 for more details.

If the Groups window is not visible, you can show it by pressing View, Group (above numeric keys).

-
- 1> *Select the fixtures/dimmers you want in the group (the order in which you select them will also be stored in the group).*
 - 2> *Press the grey Group button (top right of the numeric keys) then [Record Group]. You can also press Record then the Group button.*
 - 3> *Use softkey A to enter a number for the group, or B [Provide a legend] to set a legend.*
 - 4> *Touch an empty Group button where you want to store the group, or press C [Store] to store as a numbered group.*
 - 5> *Press Clear then repeat from 1 to store other groups.*
-

- You can also press the Avo button and the Group button to go directly to the Record Group menu, or touch the button twice to use Quick Record – on the first touch the button will turn red with a +, on the second touch the group will be recorded.



- To select all the fixtures/dimmers in a group, just press the button for the group.
- The order in which you originally selected the fixtures when creating the group is also stored. This takes effect when you use the last fixture – next fixture functions described in the next section, and when you use Shapes, Fan mode and Fixture Overlap functions. You can change this later, see the next section.
- You can also recall a group by its number:

-
- 1> *Press the grey Group button.*
 - 2> *Type in the number of the group you want to recall.*
 - 3> *Press [Recall Group].*
-

- The Group button also gives you facilities on the softkeys to edit and delete groups.

Auto Groups

When patching multiple fixtures, the console automatically creates groups for you. A fixture type group is created which contains all fixtures of the same type (for example, [All Mac 2000]). Another group is created each time you patch a quantity of fixtures (for example, [4 BB4].) This function can be turned off using [Auto Groups] in the User Settings.

4.1.14 Fixture Order and Fixture Layout in groups

Fixtures in a group are stored with a selection order, which is used with Shapes, Fan, and Overlap. You can also store a 2D position layout for fixtures, giving the actual physical location of fixtures for use with the Pixel Mapper effects.

To change fixture order:

-
- 1> *Press [Edit Times].*
 - 2> *Select the group you want to edit.*
 - 3> *Press [Fixture Order].*
-

The fixtures in the group will be shown numbered in the fixtures window.



To change the order, select [Auto Increment] to On, then select the fixtures in the order you want. If you press a fixture twice, it will show an X indicating that it is not part of the sequence.

To change fixture layout:

-
- 1> Press [Edit Times]
 - 2> Select the group you want to edit.
 - 3> Press [Edit Layout]. The Layout Editor window will open.
-

Initially fixtures will be all in a row. You can reposition the fixtures anywhere on the screen by dragging them. Or press a fixture to select then use the wheels to move it around the grid. You can resize the grid by dragging the bottom or right sides.

The [Arrange Fixtures] context command will automatically place the fixtures in a rectangular block, you specify the number of rows (Height) and columns (Width).

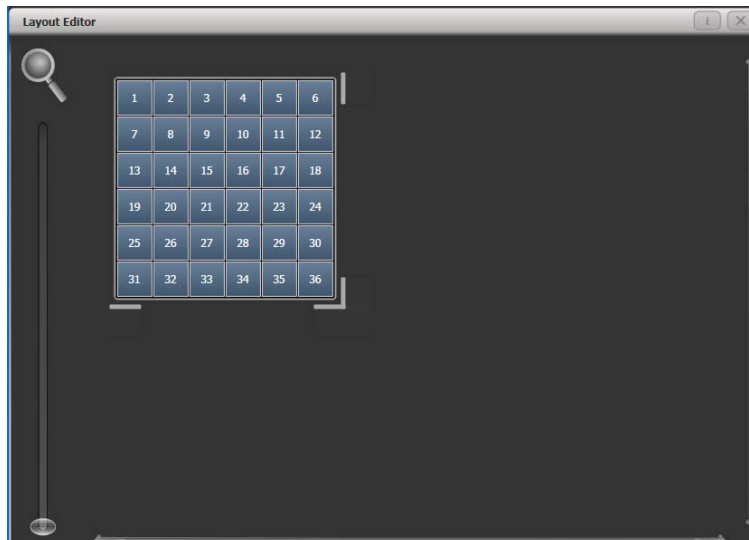

- The X-coordinate of the fixture layout is the same as the Fixture Order. Changing one will cause the other to change.
- It is possible to accidentally overlay one fixture on another, making the bottom fixture hidden. To access overlaid fixtures, drag off the fixture which is hiding it, or select the hidden fixture and use the wheels to move it somewhere visible.

- You can use the Fan button to evenly spread fixtures in the layout.

4.1.15 Stepping through selected fixtures one at a time

If you have selected a range of fixtures, or a group, the console has functions to step through the selected fixtures one at a time. This can make it easier to program a range of fixtures because you don't have to select each one manually.

This mode uses the Prev/Next/All/Hilight buttons.

-
- 1> *Select a range of fixtures or a group.*
 - 2> *The Prev and Next buttons will select the fixtures in the range one at a time (in the order you selected them).*
 - 3> *The ALL button will select all fixtures in the programmer (everything which has been selected since Clear was last pressed).*
-

- The Hilight function can be used to highlight the output of the selected fixture (make it brighter onstage), see the next section.

4.1.16 Highlighting the selected fixture with Prev/Next

When stepping through a fixture selection using the Prev/Next/All buttons, you can highlight the selected fixture on stage. This makes it very easy to see which fixture you are controlling. The other fixtures in the selection go to a dimmed "lowlight" level.

- Press the HiLight button to enable highlight mode. Press HiLight again to disable. When you are in highlight mode, the highlighted attribute is overridden and any changes you make to it are not stored in the programmer (so if the highlight uses intensity, you cannot change the intensity of the fixture).
- You can change the levels used for Highlight/Lowlight by holding Avo then pressing HiLight, [Store Highlight State] or [Store Lowlight State].

4.1.17 Flash selected fixtures to full

It can be useful when programming to see on stage which fixtures you have got selected. Press the Flash Full button to do this (Avo + Page+1 button). You may also want to turn off selected fixtures, the Flash Out button does this.

4.1.18 Turn off unselected fixtures

To turn off all unselected fixtures use the Remainder Dim function by pressing Rem Dim (Avo+All). The zero intensity is placed in the programmer and will be recorded into any cue. This is useful when removing fixtures from cues.

4.1.19 Align fixtures

You can copy attributes from one fixture to another using the Align Fixtures function. This is very useful, for example, if you've

accidentally left a fixture out of a cue you can copy settings from its neighbour.

-
- 1> *Select the fixtures you want to Align.*
 - 2> *At the top level menu press Fixture Tools/ML Menu then [Align Fixtures].*
 - 3> *Set the mask to include the attribute groups you want to copy (using the Attribute Bank buttons, or using the softkey options for exclude and include all attributes).*
 - 4> *Touch the select button of the fixture you want to copy the settings from.*
-

4.1.20 Flip

Moving head fixtures can point at the same stage position from two possible yoke positions. Sometimes to get the fixture moving the same as other fixtures, you need to swap to the opposite yoke position and the Flip function lets you do that.

-
- 1> *Select the fixtures you want to Flip.*
 - 2> *At the top level menu press Menu Latch then C [Flip Pan and Tilt].*
-



The settings used for Flip are defined in the fixture personality. If Flip doesn't work you may need to update to the latest personality.

4.1.21 Fan mode

Fan mode automatically spreads out the values on a selected range of fixtures. If used on pan and tilt, the result is spreading out "rays" of light beams. The first and last fixtures of the range are affected most, and the central fixtures are affected least. The amount of fan can be set using the attribute wheels.

As with shapes, the order in which you select the fixtures sets how the fan effect works. The fixtures you select first and last will be the ones which change most. If you use a group to select the fixtures, the order you selected the fixtures when you recorded the group is used.

The fan effect, while normally used on pan or tilt attributes, can be applied to any attribute.

-
- 1> *Select the fixtures you want to fan.*
 - 2> *Press the Fan button.*
 - 3> *Select the attribute you want to Fan using the attribute bank buttons.*
 - 4> *Set the amount of fan using the attribute wheels.*
 - 5> *Turn off Fan by pressing the Fan button again when you have finished.*
-

If you have selected fixtures from multiple groups, you can choose whether the fan effect works with or ignores the groups. For example

if you have 12 fixtures across the stage in 3 groups of 4, you may want a fan of light beams spread evenly across the stage, or you may want 3 groups of separately fanned light beams.

By holding down the Fan button you can select:

- [Ignore Groups] All fixtures are fanned as one large group
- [Fan Group as Fixture] All fixtures in a group take on the same value.
- [Fan Within Group] Fan runs across individual fixtures in each group.

Holding down the Fan button also allows you to select the Curve used for the fan. The different curves allow you to obtain different fan effects.

Fan mode needs to be used on at least 4 fixtures to give good effects. If you have an odd number of fixtures, the central fixture will not change in fan mode.

Press the Fan button again to leave Fan mode. Any effects you have set will remain in the programmer.



It's fairly easy to accidentally leave Fan mode turned on and be very confused about why the wheels aren't working properly, so turn it off as soon as you have completed the effect. To avoid this there is a User Setting 'Press and hold Fan'. If enabled, you have to hold down the Fan button to enable Fan mode. See section 12.3.3 on page 194.

Fan Curves

You can select different curves to use when in Fan mode. Hold down the Fan button and select [Curve], the options are:

- Line: Traditional fan, the first and last selected fixture are affected equally in opposite directions, the midpoint remains unchanged. This is most useful for pan.

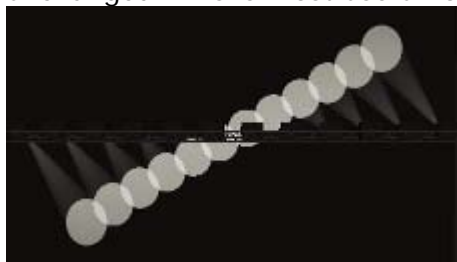

- Pull Middle - The first and last selected fixture remain at the current value, the midpoint is affected most. This is useful for colour mixing, tilt and dimmer.

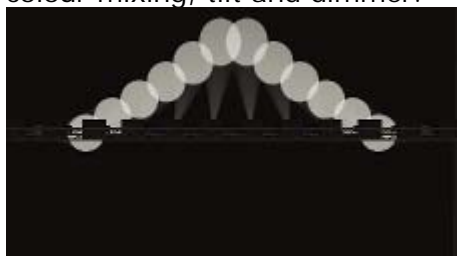

- Pull Ends - The first and last selected fixture are affected most, the midpoint is unchanged. This is useful for colour mixing, tilt and dimmer.

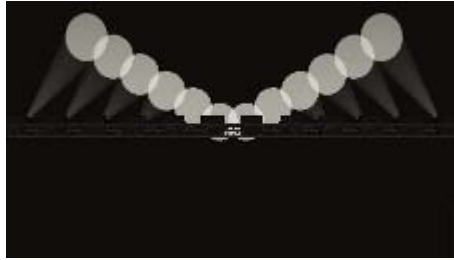

- Arrow - The first and last selected fixture are affected equally to the midpoint fixture but in the opposite direction. This is useful for colour mixing, tilt and dimmer.

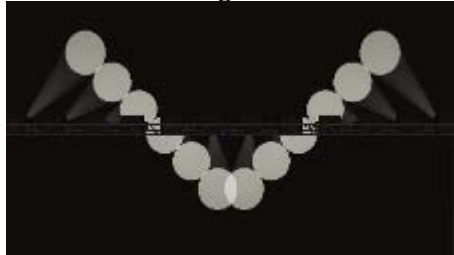

Fan Parts

When using the Fan function you can split the fan into a number of groups. Select all the fixtures, hold down Fan and type a number on the numeric keypad. The Fan will divide into that number of parts, for example:

Normal (1):

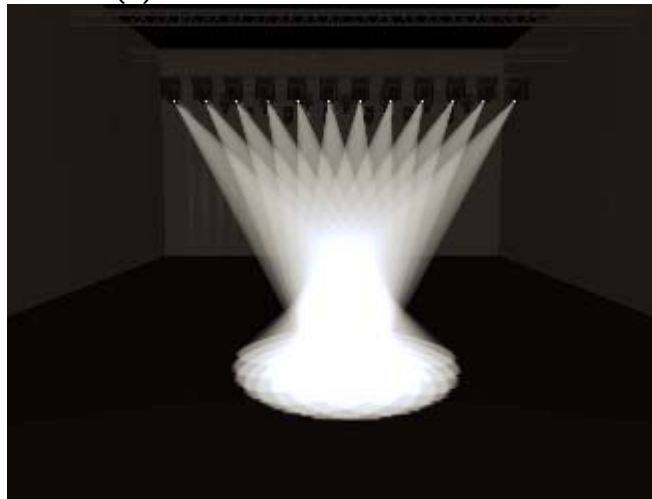

2:

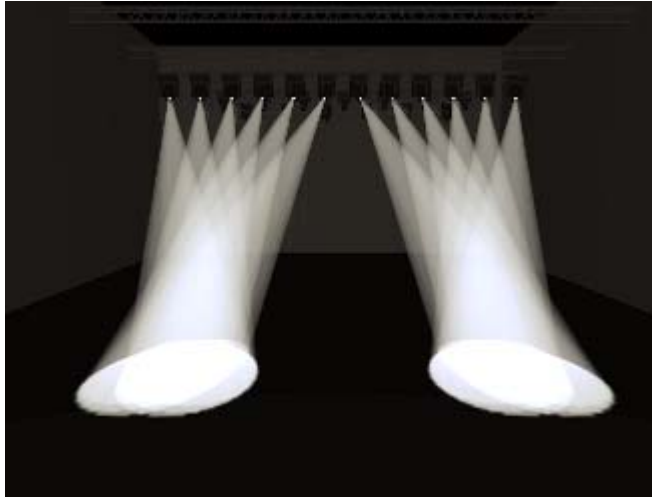

3:

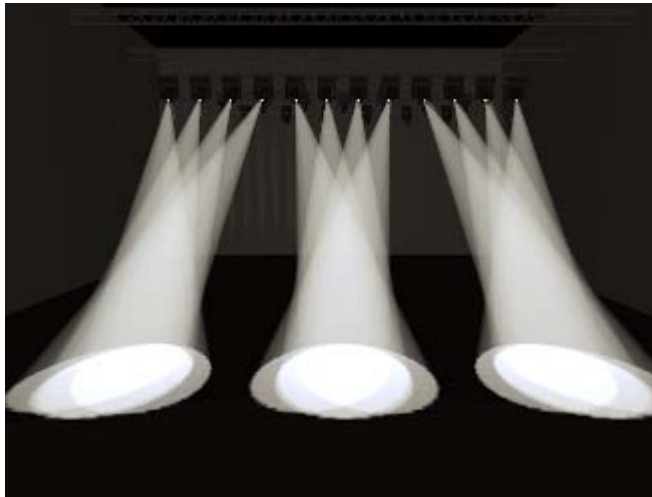

4.1.22 Setting fixture/attribute times

Fade and delay timings can be directly set for each fixture or individual attributes of a fixture. When you store the settings into a cue, the time settings will then become part of the cue.

There are a number of ways to set the times:

- You can set individual attribute times by switching the wheels to Fade Time / Delay Time mode using the [Wheels=] softkey on the root menu.
- Individual attribute times can also be set using a combination of the wheel @ keys and the TIMES key.
- They can also be set by selecting fixtures and entering into the attribute times sub-menus from the TIMES key.
- There is also command syntax that allows various options to set attribute time values - e.g. TIMES FIXTURE Position 5 @ 3 would set a 5s fade, 3s delay time onto the current fixture selection P group. Wheel @ keys can also be used in the syntax. Fan options are also available through syntax using THRO.

Setting a time attribute value will cause the 'in programmer' indication to light up.

The Channel Grid window has a Times context menu button which allows you to view or edit all the attribute times currently in the programmer. You can set a time to Off to temporarily disable it; the On option will restore the previous setting.

You can try out time settings by pressing Avo Shift + Time or double tap the Time button. (previously the SET button on Titan Mobile/Sapphire Touch and the NEXT TIME button on Tiger Touch/Pearl Expert).

4.2 Viewing and using numerical values

4.2.1 The Channel Grid window

It can sometimes be useful to display and edit exactly what each fixture is doing. The Channel Grid window allows you do to that. Display it by pressing the white Channel Grid button to the right of the screen, or pressing View then [Show workspace window] then [Channel Grid].

Channel Grid												
	Number	Dimmer	Shutter	Shutter Func	Pan	Tilt	Colour Func	Colour	CTC	CTO	Cyan	Red
ClrSp 1200	1	-	Closed		54.89	40.68	Fixed	Open		-	-	
ClrSp 1200	2	-	Closed		45.78	39.77	Fixed	Open		-	-	
ClrSp 1200	3	-	Closed		59.67	39.88	Fixed	Open		-	-	
ClrSp 1200	4	-	Closed		60.77	40.51	Fixed	Open		-	-	
ClrSp 1200	5	-	Closed		53.30	45.85	Fixed	Open		-	-	
ClrSp 1200	6	-	Closed		51.78	47.06	Fixed	Open		-	-	
ClrSp 1200	7	-	Closed		48.32	47.26	Fixed	Open		-	-	

The window can be set to different modes using the context buttons to the left of the menu. The modes are:

- Playbacks: shows which playback is controlling each attribute of each fixture
- Levels: shows the output levels of each attribute. These may be shown numerically or as range names.
- Palettes: shows which palettes are allocated to fixture attributes
- Shapes: shows which shapes are running on fixtures
- Output/Programmer: switches between the attributes on the console output, and the attributes currently in the programmer
- Highlight off/changes: if set to [Highlight changes] then changing attributes will be highlighted.
- Narrow/Wide columns: changes the column width on the screen.

You can **select** fixtures by touching the fixture names on the left of the screen, or if you select any fixture values, the appropriate fixture will automatically be selected.

You can **clear** attributes in the channel grid by selecting them (touch or touch and drag to select multiple attributes). Then press Clear.

You can **edit values** by selecting one or more values in the grid, then modify the values using the wheels, or type a new value on the numeric keypad and press Enter.

4.3 Advanced options

4.3.1 The Fixture Tools / Menu Latch button

When the console is at the top level menu, this button opens the Moving Light Actions menu which contains options to Locate Fixture (same as the Locate button) and to run Macros on fixtures such as Lamp On, Lamp Off, Reset etc. The Align Fixtures and Flip functions as described above are also in this menu.

If another menu is loaded, the button latches the current menu. Press Exit to get back to the top menu so that you can access the Moving Light menu.

4.3.2 Lamping fixtures on and off

Many fixtures have a control channel which allows you to perform functions like lamp on, lamp off, fixture reset, and so on. This can be useful to shut down fixture lamps at the end of a show while the fans continue to run, or to reset a fixture which has gone haywire.

The console allows you to access these functions using Fixture Macros (not the same as keypress macros).

-
- 1> *Keep pressing Exit until you are at the top level menu.*
 - 2> *Select the fixtures you wish to control. Some macros will not work across groups of fixtures from different manufacturers.*
 - 3> *Press Fixture Tools/ML Menu then [Macros].*
 - 4> *The softkeys show a list of the functions available. Press the one you want to action.*
-

- Some macros involve timed sequences and can take up to 30 seconds to execute.

5. Palettes

When programming a show you will find that you frequently use certain positions, colours, etc. The console lets you store these settings so you can recall them at the touch of a button rather than having to find them on the wheels every time. This is very useful when busking a show.

When you use a palette to record a cue, the console stores a reference to the palette, rather than the actual value. This means that if you program your cues using palettes, you can easily change all the positions in your show just by reprogramming a few palette entries rather than having to reprogram all the cues. This is handy if you are touring and have to cope with different stages or truss heights every show.

Palettes are stored and selected using buttons on the touch screen, grouped into different windows for Colours, Positions and Gobos & Beams. You can set a legend for each button so that you know what you're going to get.



If the Colours, Positions, Gobos & Beams windows are not shown, press View then [Open Workspace Window] then [Groups and Palettes] to show all three windows.

5.1 Creating palettes

5.1.1 Which attributes are stored in palettes

Although each palette entry can store all attributes of a fixture, it's easier to operate the console if you create some palettes which only set positions, some for colour, some for gobo and so on. The console helps you with this by providing separate windows for Colour palettes, Position palettes, and Gobo/Beam palettes.

When you store a palette, it will only contain what's in the programmer (the attributes you have changed since you last pressed Clear). For example to create a colour palette you would just set the colour, and not change any other attribute. You can also make palettes which contain effects such as shapes and pixel mapping. If fade or delay times are programmed for fixtures or attributes, these will also be stored in the palette, and you can create palettes which contain only time information.

If the programmer contains more than one attribute, you can set a mask to restrict which fixture attributes will be stored in the palette.

Palette information may be either Shared or Normal. Shared palettes are used where the same value is set for all fixtures of the same type – for example when setting colours, the "Red" palette would set the same colour values for "Red" to all MAC 2000 fixtures. Normal palettes are used when each fixture requires its own value - for example when programming positions, each fixture will have a different setting.

It is possible, by merging information into palettes, to create a palette which contains both shared and normal attributes.

5.1.2 Storing a palette

This is how you save a palette value:

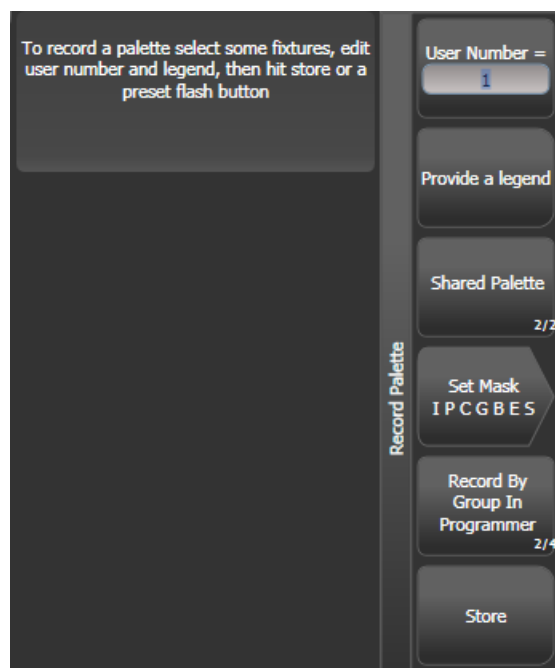

1> Press Clear to clear the programmer.

2> Select the fixtures for which you want to store palette values.

- 3> *Using the attribute buttons and wheels, set the attributes you want in the palette entry. You can store any or all attributes of a fixture in each palette entry.*
 - 4> *Press the Record Palette button.*
 - 5> *Set the palette Mask – this sets which attributes will be recorded in the palette. Select attributes using the Attribute Bank buttons – anything lit up will be saved. [Set Mask] and [Record by] softkeys also control the Mask (see below).*
 - 6> *Press an unused Palette button to store the palette (available buttons will flash). Or enter a palette number and press [Store]*
-
- The console will automatically set the palette as Shared or Normal (by checking if the values to be stored are the same across all fixtures of the same type). You can override the setting by pressing softkey C.
 - [Set Mask] allows you to specify which attribute groups will be included in the palette. You can also use the grey Attribute Bank buttons on the right hand edge of the console to set the mask.
An attribute group is included when the softkey is inverted (like the Colour group in the picture) and when the LED is lit on the Attribute Bank button. If you use Quick Record (see next section) the mask is automatically set by the workspace window you save the palette in – Positions only includes P, Colours only C and Beams includes IGBES. If you use the Record Palette button then you need to set the mask manually.
 - Press the Attribute Options button to toggle all mask groups between Include and Exclude.

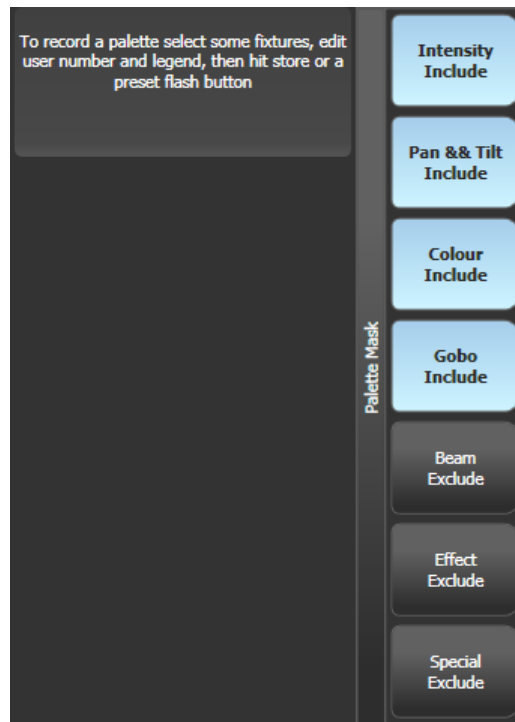

- [Record By...] allows you to control how the mask is used when saving the palette. The options are:
[Channel in programmer] records only channels which are in

the programmer (which have been changed)
 [Group in programmer] records all channels in any attribute group which has one or more channels in the programmer. For example if Cyan is in the programmer, all colour channel settings will be recorded even if not in the programmer.
 [Group in mask] records everything included by the mask set on the attribute buttons
 [Mixed] records by attribute group for Position and Colour but by channel for all other controls.

- The console will automatically create a legend for your palette (unless the User Setting [Auto Legend] is set to Off). For colour palettes a coloured icon is used to show the selected colour. If the palette contains fixtures set to different colours, a coloured bar will be shown for each. For CITP (media server) palettes, the media thumbnail will be used. For other attributes the last adjusted function value will be used for the legend, except for pan and tilt which will use a default legend.



- You can also manually set a legend for the palette while you are saving it using [Provide a legend]. See section 5.1.4 for how to change the palette legend.
- If you select a Palette button which is already used, the console offers you options to [Cancel], [Replace] or [Merge] the existing palette. [Replace] will erase the palette and save only the latest changes you have made. [Merge] will combine your changes with the palette. This allows you to add settings for additional types of fixtures to a shared palette or to update the existing fixture settings. Pressing the palette button again will automatically merge. The palettes are merged using Quick Merge, which has a mask to include or exclude attribute types.

5.1.3 Quick record

The palette windows allow you to quickly record a new palette. Just touch the button where you want to record – the button will turn red with a + sign. At this point you can enter a legend for the new palette or change mask settings. A second press on the button will save the palette.



- When using Quick Record, the palette mask is automatically set to match the window, so if you touch a button in the Position window, the mask will be set to only store position attributes. This does not happen if you use the Record Palette button.

Quick record also works for groups, workspaces and the playback window.

5.1.4 Setting legends for palettes

You can enter a legend for each palette which is displayed on the palette touch button.

- 1> Press [Set Legend] at the top level menu.
- 2> Press the palette button for the palette you want to legend.
- 3> Type the legend on the keyboard.
- 4> Press Enter when you have finished.

- On touch buttons, the palette number is shown top left. The IPCGBES attribute groups contained in the palette are displayed below your legend, so for example Position palettes will show a P, colour palettes a C and so on. In the top right corner is shown N for a Normal palette or S for Shared.



You can create a picture legend for your palette which could for example represent the colour or gobo it will create. After pressing [Set Legend] and the palette button, press [Picture]. The picture editor will open.

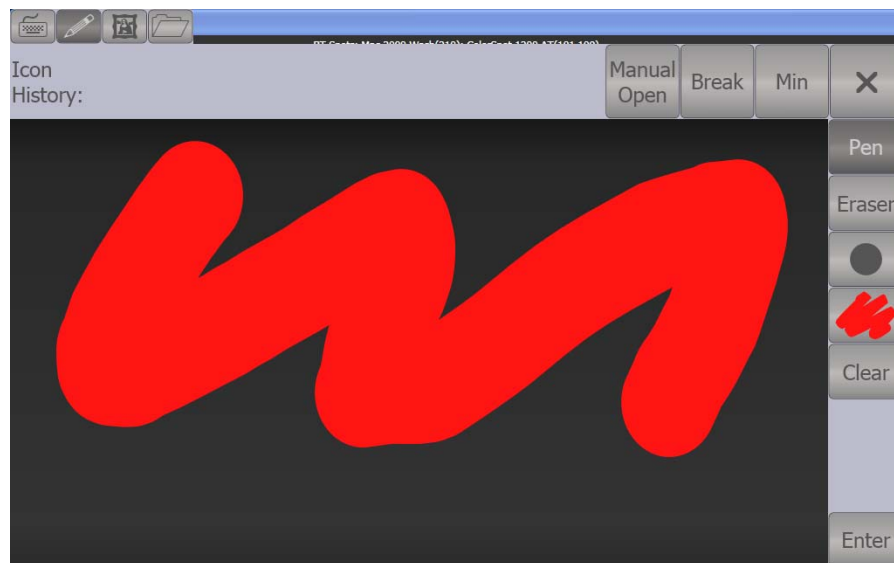

The tab buttons on the top left allow you to select Keyboard entry (legend reverts to text), Draw, Icon Library, or Load File. On the right you can choose Pen or Eraser, set the pen/eraser size, set the colour (white in the above picture), clear the whole picture, and Enter the legend. The Min button top left reduces the editor to a smaller size.

If you select Library you can choose a picture from a wide range of pre-programmed pictures. The pictures are sorted into various folders which are listed on the left.



5.1.5 Creating an effects palette (shape or pixel mapper)

It can be very useful to create some palettes which apply shapes or pixel mapping effects.

For an effects palette to be useful, it needs to contain only effect settings (for example, for a pan/tilt circle you want it to move the fixtures around their current set position, not to change the position as well). To achieve this you can either use the FX mask when saving the palette, or you can just remember not to set any other values when programming.

- 1> Press Clear, select some fixtures and locate them. If you need to move them so you can see what's happening, you can do that too.
- 2> Press [Shapes and Effects], [Shape Generator] and choose a shape to start (see section on page for more information about shapes).
- 3> Alter the parameters of the shape as you require.
- 4> Press Palette, [Record Palette].
- 5> If you moved the fixtures in step 1, press [Set Mask] and exclude everything except FX.
- 6> Press a palette button to store the shape palette.

5.1.6 Creating a time palette

You can create palettes which contain only time information. These can be used to set cue times and fixture attribute times without needing to set times manually. Using a time palette also means that you can go back and change the times once in the palette, and the changes will automatically apply to all cues which use the palette.

- 1> Press Clear, select some fixtures and locate them. If you need to move them so you can see what's happening, you can do that too.
- 2> Press Time (previously Set button on Mobile/Sapphire, and Next Time on Expert/Tiger).
- 3> Change Fade time to 2 sec. This sets the global fade time into the programmer.
- 4> Press Palette, [Record Palette].

- 5> *If you moved the fixtures in step 1, press [Set Mask] and exclude everything except Time.*
- 6> *Press a palette button to store the Time palette.*
-

5.2 Recalling palettes

5.2.1 Recalling a palette value

To recall a palette value from a button, this is what you do:

-
- 1> *Select the fixtures to be changed. Shared palettes can be set to any fixture of the same type. Normal palettes will set individual values to each fixture.*
- 2> *Press the Palette button you want to recall. The palette will be set to the selected fixtures.*
-

- You can make palettes fade over a time when you recall them, see section 0 below.

You can also recall a palette by its number by typing the number on the numeric keypad.

-
- 1> *Select some fixtures.*
- 2> *Press the Palette button above the numeric keypad.*
- 3> *Type in the number of the palette you want to recall.*
- 4> *Press Enter or [Apply Palette].*
-

- The [Apply Palette] softkey shows the legend of the palette which will be applied.

5.2.2 Palette pages

Each of the palette windows can either display pages of palettes, with page buttons on the left, or a continuous scrolling window of palettes. To change between pages and scrolling, touch the Pages Show/Hide button in the context button area to the left of the menu buttons. using the page buttons to the left of the palette buttons.

- You can recall a palette from any page using its number as described in the previous section.

5.2.3 Quick palettes with no fixtures selected

If you press a palette button when no fixtures are selected, the palette will be set to all the fixtures the palette applies to. This is called a Quick Palette. For example if you've got some colour palettes programmed for your MAC 2000's, pressing one of the palettes when no MAC 2000's are selected will set the colour to all the MAC 2000's.

5.2.4 Setting palettes to all fixtures in a playback

You can apply a palette to all fixtures in a particular playback. Hold the palette button and press the select button of the playback which the palette is to apply to.

5.3 Editing palettes

5.3.1 Viewing and editing the content of palettes

You can view the contents of a palette in the Palette View window. This lists all fixtures in the palette and the attribute values stored for them. A context menu button allows you to switch to displaying Times.

Press View, then the palette button. The Palette View window will open.

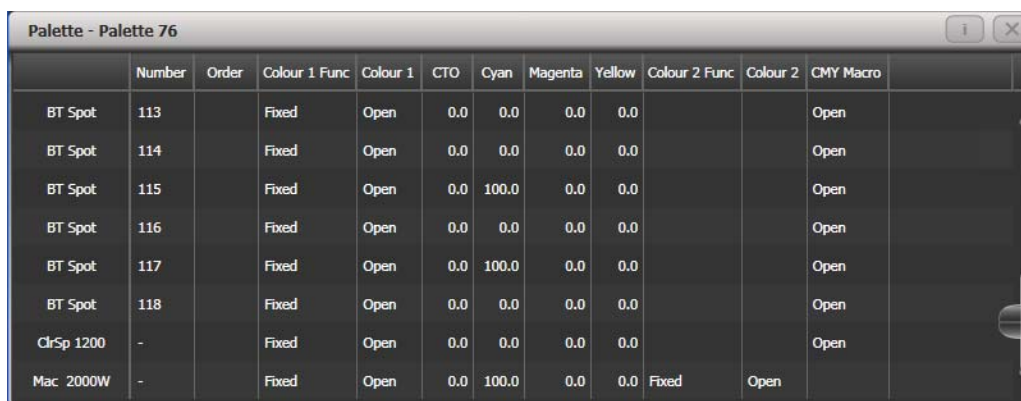

	Number	Order	Colour 1 Func	Colour 1	CTO	Cyan	Magenta	Yellow	Colour 2 Func	Colour 2	CMY Macro
BT Spot	113		Fixed	Open	0.0	0.0	0.0	0.0			Open
BT Spot	114		Fixed	Open	0.0	0.0	0.0	0.0			Open
BT Spot	115		Fixed	Open	0.0	100.0	0.0	0.0			Open
BT Spot	116		Fixed	Open	0.0	0.0	0.0	0.0			Open
BT Spot	117		Fixed	Open	0.0	100.0	0.0	0.0			Open
BT Spot	118		Fixed	Open	0.0	0.0	0.0	0.0			Open
ChrSp 1200	-		Fixed	Open	0.0	0.0	0.0	0.0			Open
Mac 2000W	-		Fixed	Open	0.0	100.0	0.0	0.0	Fixed	Open	

To edit an attribute value, touch/click on it in the window. The softkeys will give you a list of available settings for this attribute or you can type in a numerical value.

There is also a [Delete] button which allows you to remove the value from the attribute. This is the same as using the Off function.

5.3.2 Changing the content of palettes

To edit a palette entry, press the Update Palette button, select the palette to edit (this will automatically select the fixtures used in the palette), make the changes you want, then press the [Update Palette x] softkey to save the changes.

The Update Palette button also allows you to change the palette name and number.

You can also load the palette into some fixtures, modify the attributes and record the new information back on top of the existing palette entry. The console will give you options on the softkeys to Replace, Merge or Quick Merge the palettes. If you select Merge, anything you haven't changed will not be affected, values you have changed or added will be amended. Quick Merge will only update the attributes stored in the original palette and ignore others (for example if you are merging with a position palette, but have also modified the colour attributes, the colour attributes would not be merged in).

When double clicking a palette button to update, the default option is Quick Merge.

- You can set the console to "Always Merge" (so it doesn't ask you) using option A of the User Settings (hold down the Avo button to set these). You can also press the palette button a second time to select the Merge option.
- You can add additional fixtures to a palette without affecting existing ones. For example, if you have colour palettes for Mac

600s, you can add colours for your Mac 500s without affecting any previously recorded values in the palette.

- You can remove attributes from palettes using the Off function, see section 7.3.5 on page 133.
- When editing a palette the state of the programmer will be preserved; when the modified palette is saved, your original programmer contents will be restored and the programmer will be left in the same state as when you started editing the palette.

5.3.3 Updating palettes used in a playback

If you need to quickly update a palette during a show, for example you fire a green cue and the Green palette used turns out to be not quite the right colour, the Update function lets you automatically update the palette used in the cue.

-
- 1> *With the cue fired, select the fixtures and change them to the settings you want to store (e.g. the right green colour).*
 - 2> *Press Record Cue, [Update].*
 - 3> *The cues and palettes which can be updated are shown on the softkeys and all other buttons are greyed out.*
 - 4> *Press the palette button (for example, Green) twice to update that palette.*
-

- You can also select multiple palettes to be updated by highlighting them in the softkeys then pressing Enter to confirm.

5.4 Copying, moving and deleting palettes

5.4.1 Copying or moving a palette

Using the Copy/Move/Link button you can make a copy of an existing palette or move it to a new button. You can copy or move multiple palettes in one operation. You cannot link palette buttons.

Move is useful for tidying up the console.

-
- 1> *Press the Copy/Move/Link button.*
 - 2> *Select [Copy] or [Move]. Pressing the Copy/Move/Link button again will also toggle these options.*
 - 3> *Press the Select button of the palette you want to copy/move. You can select multiple palettes.*
 - 4> *Press the empty button where you want it to go.*
-

- The Menu Latch button latches the Copy/Move/Link menu, so you can keep copying, moving or linking things without having to keep pressing the Copy/Move/Link button. Press Exit to unlatch.
- [Retain Layout] or [Bunch Up] is used when copying a group of palettes with empty handles in the group – you can either keep the empty handles, or bunch up the used handles together.

- When in Copy mode, option [Copy Legends] can be changed to [Don't copy legends] so that the copied palettes are given default legends.
- When in Move mode, [Swap Items if Required] will attempt to reposition any existing handles which are in the way of the move. This is useful when rearranging buttons on a page which is nearly full.

5.4.2 Deleting palettes

You can delete a palette entry by pressing the Delete button, then pressing the palette select button to be deleted. Press the palette button again to confirm the deletion. You can delete a range of palettes in one go by running your finger along the buttons.

Other ways to delete a palette:

- Press the Update Palette button, select a palette, use the [Delete] softkey option.
- Press the Palette button above the numeric keypad and use the [Delete] option in the [Palette Utilities] menu.
- Press Delete then [Palette], type the palette number, press Enter.
- If you have playbacks which use the deleted palette, they will go back to the values which were stored in the programmer when the playback was recorded.

5.5 Timing with palettes

Palettes may be saved with timing information, or you can manually override the timing when recalling the palette.

5.5.1 Palettes with saved times

If you have saved time information in a palette, it will normally recall with this timing information. So if you programmed a 2 second fade, the palette will recall with a 2 second fade.

You can turn this off (which can be useful during programming) using the key profile setting for palette keys (see section 12.2.1 on page 192). You can set [Palette Is Fired With Its Times] or [Palette Is Fired Ignoring Its Times].

5.5.2 Manually overriding palette times

Being able to recall palettes with a manual fade allows easy "busking" of shows. When a palette is recalled in this way, a time is added and the palette fades in over that time.

-
- 1> *Select some fixtures.*
 - 2> *Type in the fade time for the palette on the numeric keypad.*
 - 3> *Press a palette button to recall the palette.*
-

- This overrides any timing stored in the palette itself.
- You have to re-enter the time each time you recall a palette. To use the same fade every time, set a Master Time: Press Palette, [Master Time]. To disable Master Time set to 0.

- Palette fading can be very useful when recalling a palette live during a show, as you can smoothly move fixtures to a new position or change colour slowly (on colour mixing fixtures).
- Palettes applied with a fade time do not get put into the programmer, so will not be saved in any cues; don't use fade times when programming. This is to ensure that when used in a live situation, the next cue will override the palette and play back as intended.

5.5.3 Manual fixture overlap when recalling palettes

You can set a Fixture Overlap when recalling a palette, which means that the palette will be applied in sequence to each fixture in the group. This is a very quick way to busk some amazing effects. Fixture Overlap=100% means that all fixtures will change together. Fixture Overlap=0% means that each fixture must complete its fade before the next will start its fade.

-
- 1> Type in the overlap time for the palette on the numeric keypad.
 - 2> Press [Set Overlap].
 - 3> Type in the fade time if fade is also required.
 - 4> Press a palette button to recall the palette.
-

- You have to re-enter the overlap each time you recall a palette. To use the same overlap every time, set a Master Overlap: Press Palette, [Master Overlap]. To disable Master Overlap set to 100%.

5.5.4 Master Time for palettes

Option [Master Time] on the Palette menu (press the grey Palette button above the numeric keypad) allows you to set a default fade time. This fade time will be used for all palettes unless you manually type in a different time. This can be useful when "busking" a show with palettes.

The [Master Overlap] option similarly sets the default Overlap for palette recall.



You can create macro buttons to set different palette fade times. Press Macro, Record, press a button to store your macro on. Then press Palette, [Master Time], 3 (for 3 sec), Exit, Macro.

Repeat these steps to create a Palette Snap button (0 sec), or a 1 sec fade button, and so on.

6. Shapes and Pixel Mapper effects

The Shape Generator in the Tiger Touch (sometimes known as an Effects Generator on other consoles) allows you to quickly create exciting light shows using lots of movement and changes, with the minimum of programming.

The Pixel Mapper is used to generate animated textures using the colour or intensity of a group of fixtures (often LED battens, starcloths or LED web type fixtures). When viewed at a distance the effect becomes clearly visible.

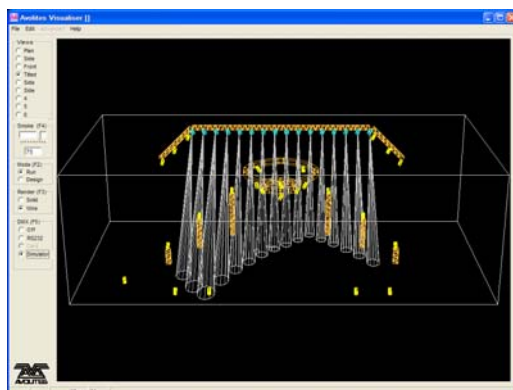

A shape is simply an automatic sequence of values which can be applied to any attribute of a fixture. A circle shape, for example, applied to the pan and tilt attributes, would cause the fixture to move its beam around in a circular pattern. You can set the centre point of the circle, the size of the circle and the speed of the circle movement.

In addition to position shapes, there are a large number of other shapes available in the Tiger Touch. The shapes are defined for a particular attribute such as colour, dimmer, focus and so on. Some shapes will not work with some fixtures; focus shapes, for example, can produce nice "focus pull" effects on fixtures which have DMX focusing, but will do nothing on fixtures which don't have focusing.

A further category of shapes is the Block Shape. This type of shape blocks out other shapes, preventing them from running. For example, if some fixtures are running a Circle shape, and then a playback is fired which has a Block Pan/Tilt shape on some of the fixtures, those fixtures will stop running the circle shape. This can be very useful to modify playbacks at showtime when used with the playback priority feature (see section 7.6.5 on page 140).

When you use a shape with more than one fixture, you can choose to either apply the shape identically to all the fixtures, or offset them so that the shape runs along the fixtures creating "wave" or "ballyhoo" type effects. This is called the *Phase* of the shape.

6.1 Creating effects

6.1.1 Creating a shape

To create a shape you simply pick the attribute of the shape from a list on the softkeys, then choose the shape you want from the Shapes window. Shapes are organised using the IPCGBES attribute groups, so you can pick from a list of Dimmer shapes, or a list of Pan/Tilt shapes, or Colour shapes, and so on. You can also pick from a list of All Shapes.



When you create a shape, it will be applied to all selected fixtures.

-
- 1> *Select the fixtures the shape is to be applied to.*
 - 2> *At the main menu press [Shapes and Effects] then [Shape Generator].*
 - 3> *Press [Create] to start a new shape.*
 - 4> *Press a softkey to select the attribute type to use in the shape or press [All shapes] for a full list.*
 - 5> *Press a softkey to select a shape, or touch the desired shape in the Shapes window. You can type a search word on the keyboard to search for a particular shape.*
 - 6> *The shape will be applied to all selected fixtures.*
-

- If you open the Shapes window, it will remain open for instant selection of shapes (you don't need to select [Shape Generator]). The window will only show shapes which are possible on the selected fixtures. Pressing attribute buttons will filter the Shapes window to show only shapes for that attribute. Press the Dimmer attribute button to show all shapes.



- Shapes are based on the current settings of the fixture, so a position circle would move around the current pan-tilt position of the fixture.
- You can change the base value of a shape (e.g. the centre of a circle) by changing the attributes using the wheels in the usual way. You can reduce the Size to zero (see next section) to help you see what the base value actually is.
- You can run more than one shape at a time by repeating the above procedure. You can run several shapes on one fixture and the output will combine in interesting ways.
- Press [Shapes and Effects], [Shape Generator] then [Edit] to show what shapes are running.
- If you apply the same shape to two different groups of fixtures, the shape will appear twice on the shape list. You can edit the two shapes separately to give different directions, speeds etc (see later)
- If the selected fixture has subfixtures (cells) then you will be given the option to run the shape on the main fixture, keeping all cells identical, or spread across the subfixtures/cells.
- Each shape is designed to work on a particular attribute. Obviously if the fixtures don't have the attribute, you will not see any effect if you use the shape.
- Each shape has a default size and speed setting (defined in the shape file).



When using a Rainbow colour shape, to get the full range of colours you need to set the CMY or RGB attributes to 50%.

6.1.2 Changing size and speed of a shape

It is easy to change the size and speed of a shape after it has first been created. If the display above the wheels is showing Spread and Offset rather than Size/Speed, press softkey E to select [Adjust Speed, Size and Phase].

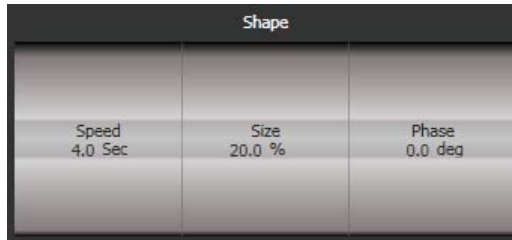

-
- 1> *Control the speed of the shape using the left hand wheel.*
 - 2> *Control the size of the shape using the middle wheel.*
 - 3> *The size and speed is shown above the wheels on the display.*
-

Other things to know about size and speed of shapes:

- If you have more than one shape running, the controls operate on the most recent one. You can edit the parameters of any shape that's running using the Edit Shape function, see section 6.2.1.
- The minimum size is zero. This will "hide" the shape, and the fixture will resume its previous settings. The shape is, however, still active.

6.1.3 Changing the phase of a shape across multiple fixtures

Shapes get more interesting (and look more impressive) when you apply them to multiple fixtures. You can control how a shape is phased across several fixtures. You can also control Spread, which is a different way of selecting the same thing.

The sequence of the shape across the fixtures is controlled by the order in which you selected the fixtures when you created the shape..

-
- 1> *Press softkey E to select [Adjust Phase, Spread and Offset]*
 - 2> *Control the phase of the shape using the left hand wheel, or to set in terms of Spread, use the middle wheel.*
-

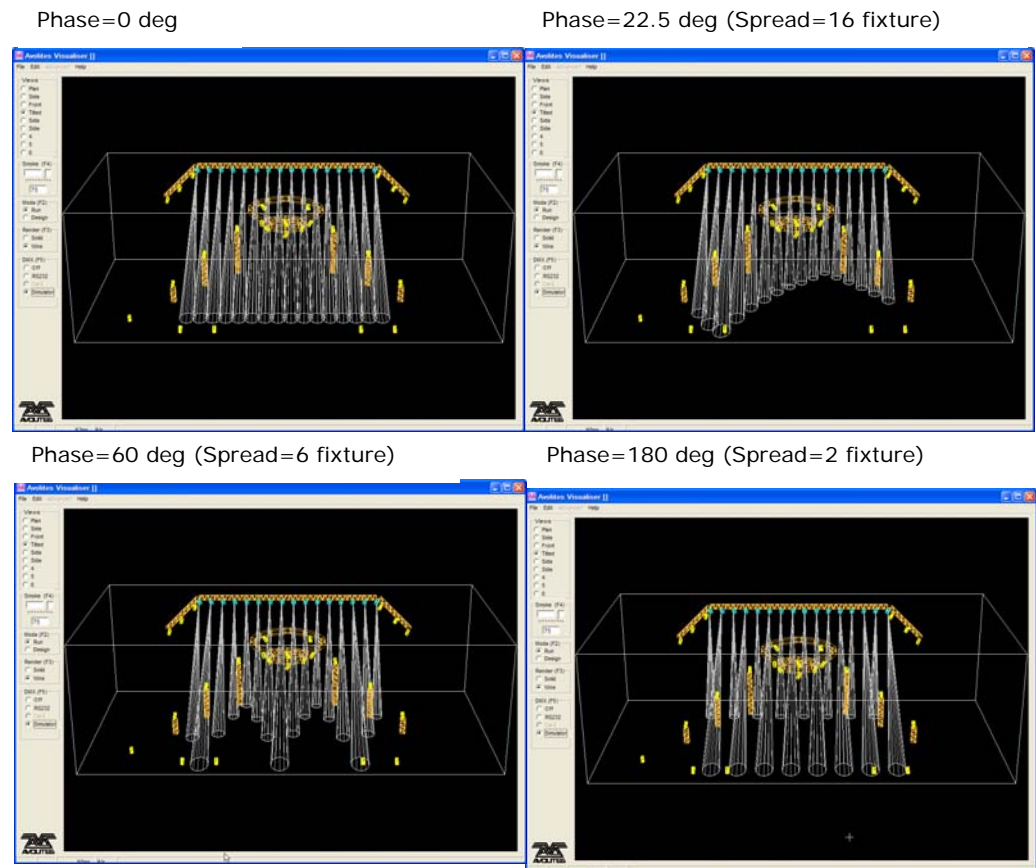

The display above the left hand wheel shows the phase in degrees. For example, 180 degrees repeats every 2 fixtures, 90 degrees repeats every 4 fixtures, 60 degrees repeats every 6 fixtures, and so on.

The Offset function allows you to set the starting phase of the shape, when more than one shape is running. For example, if you were running a Cyan shape and a Magenta shape to create a mix of colours, you would probably want to start them with Cyan at full and Magenta at zero to give the full range of colours. In this case you would set one of the shapes to have a Phase Offset of 180 degrees. Without the phase offset, both shapes would reach full at the same time.

6.1.4 Creating Pixel Mapper effects

The Pixel Mapper works on a group of fixtures, which you have set up using the Fixture Layout function. This tells the console where the fixtures are physically located on the stage. The console then maps the fixtures as pixels and uses them to output a 2D effect. See section 4.1.14 on page 72 for details of how to layout the fixtures.



At the end of this section (Section 6.4 on page 102) there are a number of step-by-step examples of creating effects with the pixel mapper.

You set up the Pixel Mapper as follows.

- 1> Select the group of fixtures.
- 2> From the top level menu select [Shapes and Effects] then [Pixel Mapper]
- 3> Select [Create effect]. The Pixel Mapper Editor will open with a blank background. You can overlay your fixture layout on the window, to help you see where your fixtures are, by clicking on the [Fixture Overlay 50/50] context menu button.

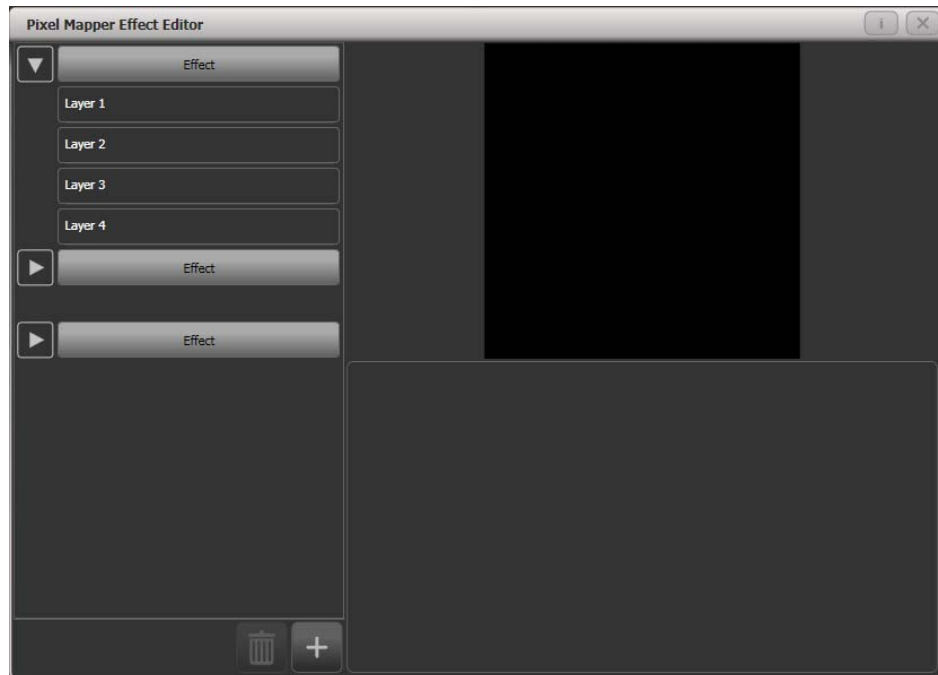

Click on the + button at the bottom to add an effect, and choose a graphic element. The graphic buttons as shown below provide the following effects:

- Square
- Circle
- Triangle
- Star
- Fan
- Spiral
- Text
- Scribble (you draw an image on the touch screen)
- Image/bitmap (loaded from disk)

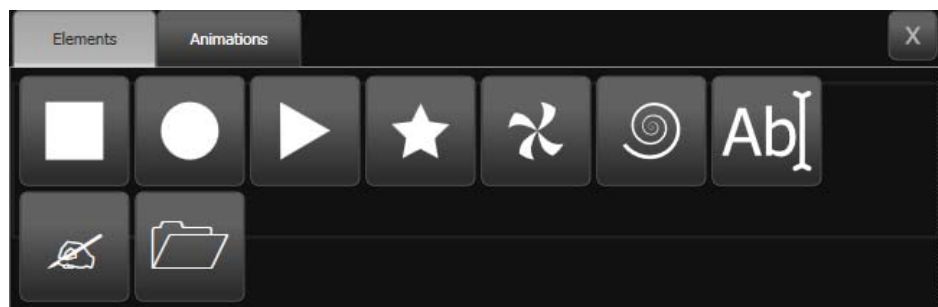

Then click on the + button again and choose an animation (how your graphic element will move). The animated effect will show in the black window.

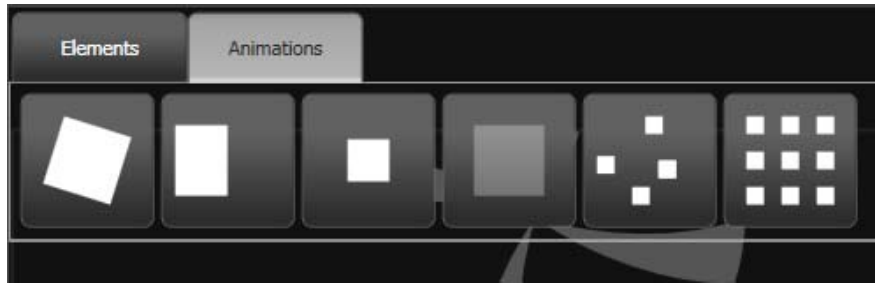

Available animations are:

- Rotate
- Slide
- Zoom
- Opacity/Fade
- Random
- Grid Fit (elements will accurately align with the pixel grid)

Edit the parameters of the effect by clicking the effect name on the left hand side. Sliders are provided to configure the effect, the sliders may vary depending on the particular effect. For Grid Fit you need to specify the number of rows and columns in the grid.

Edit the colour of the effect by clicking on the Layer on the left hand side.

Edit the way the animation moves by clicking the animation name on the left.

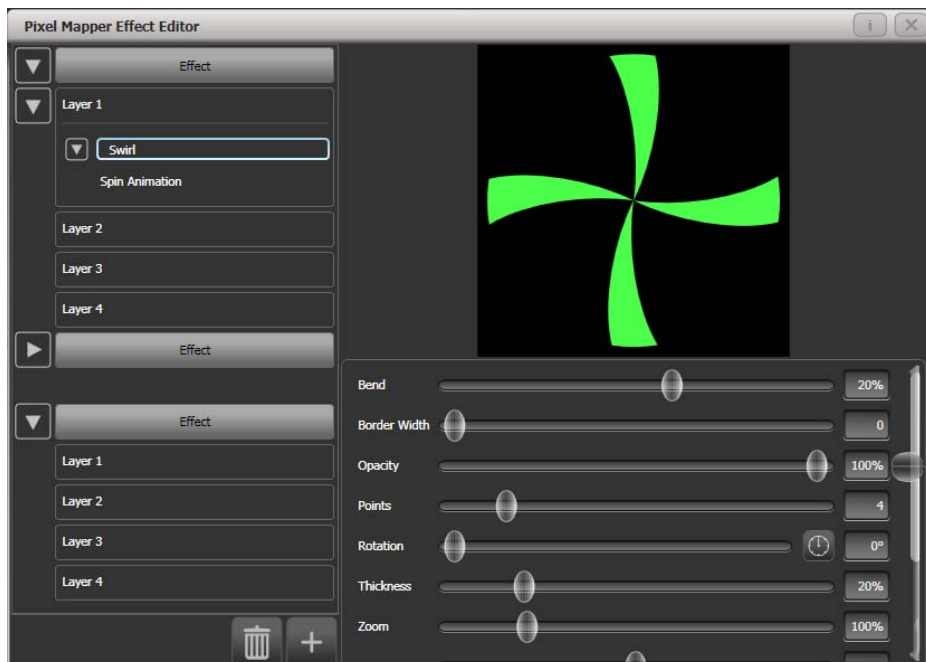

To see how the effect will look on the fixtures, open the Pixel Mapper preview window by pressing View, [Open Workspace Window], [Pixel Mapper Preview]. A real life view of each effect running is shown in a

button at the bottom of the screen, you can select each of these by pressing the button.

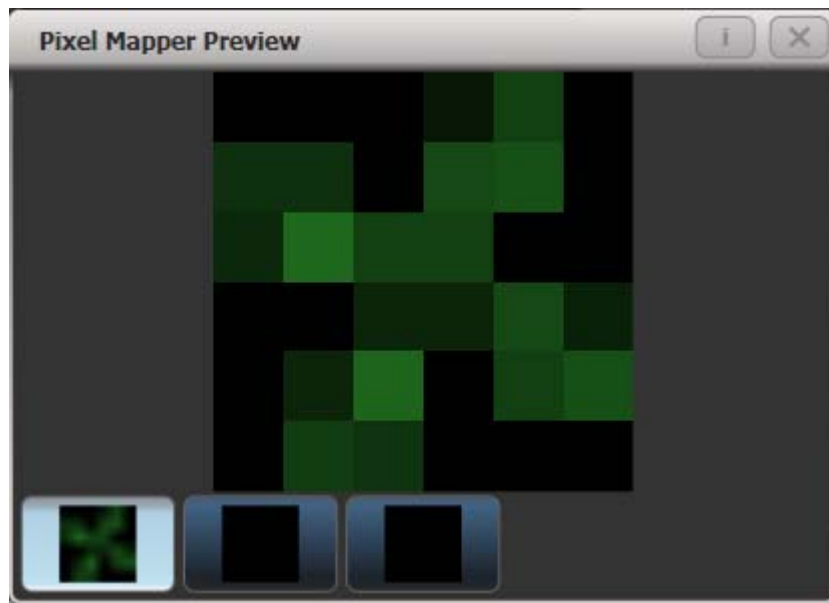

If you wish you can overlay further layers on the effect. Once you have an effect you like, you can save it to a playback.



When adjusting the parameter sliders, as well as using click/drag on the screen you can also use the wheels or type in a numerical value. To assign a slider to the wheels or for numerical input, click the value box to the right of the control. Double click the value to reset it to its default, or use the +/- softkey to change the sign of the value.

6.1.5 Pixel mapper Layer Masters

You can assign each of the four layers to a master. The master allows you to adjust the layer controls in real time. When the master is assigned to a fader handle using the [Assign Masters] [Pixel Mapper] controls, the fader will control opacity of the layer.

This means you can create cues and palettes which can manipulate the layer settings of effects which are running in other cues.

To enable the layer master, turn on the Use Master switch in the effect editor window.

- Layer masters may require an updated personality file.

6.2 Editing shapes and effects

6.2.1 Editing shapes and effects in cues

Shapes and pixel mapper effects stored in cues can be edited from the Cue View window.

Playback View - Cue 'Fast Dim Shape'										
	Delay In	Fade In	Fade Out	Fixture Overlap	MiD Delay	MiD Fade	Curve	View Cue	View Shape	View Pixel Effect
0	0	0	Disabled	100%	0	0	Linear	View	Dimmer Pulse 1:1	

To view and/or edit the parameters of the shape or effect, click on the View Shape or View Pixel Effect button. If more than one shape or effect is stored, the button will show [...]. A Shape View window or Pixel Mapper Effect View window will open, listing the shapes or effects in the cue. You can then edit parameters of the shape or effect by clicking on the parameter and editing on the softkeys.

In the Shape or Effect View window you can click on View Fixtures to open a window showing a list of the fixtures on which the shape or effect is programmed.

6.2.2 Selecting a running shape to edit

You can only edit shapes which are in the programmer; if you fire a cue with a shape in it, the shape will not show up in the list of editable shapes. To get the shape into the programmer you need to use the Include function (see section 7.3.4 on page 133).

If more than one shape is running in the programmer, you can select which one is connected to the control wheels using Shape option [Edit].

-
- 1> *If you are not in the Shape menu, press [Shapes and Effects] then [Shape Generator] at the top menu.*
 - 2> *Press [Edit].*
 - 3> *Press [Select shape]*
 - 4> *By the softkeys is a list of the currently running shapes.*
 - 5> *Press a softkey to make the shape active. The active shape is highlighted.*
 - 6> *Press Enter to get back to the Shape Generator menu.*
-

- If you applied the same shape several times to different fixtures, you can change each copy of the shape independently.

6.2.3 Changing fixture order in a shape

The way a shape spreads across a number of fixtures is set by the order in which you selected them when you create the shape. You can change this order using the [Fixture Order] function in the [Edit] menu. The current fixture order is shown in large green numbers on the HUD window, or in the fixture touch keys. See section 7.5.2 for details on how to set fixture order.

6.2.4 Removing or adding fixtures

You can add or remove individual fixtures from a shape using the [Add/Remove Fixtures] option in the [Edit] menu, or use the context menu button in the Shapes Fixture view window. All fixtures currently included in the shape will be selected. You can select or deselect fixtures to add or remove them from the shape.

6.2.5 Reversing a shape

You can reverse the direction of a shape by pressing [Reverse Selected Fixtures] from the shape menu. The shape will be reversed only on fixtures which are selected, allowing you to run the shape forward on some fixtures and backwards on others.

6.2.6 Deleting shapes

You can delete a running shape by pressing [Delete] from the shape menu, then pressing the softkey for the shape you want to delete.

6.3 Advanced options

6.3.1 Fading shape size and speed

When a shape is stored in a cue, you can set how the shape fades in using the Edit Times and the Playback Option settings.

To set the shape size and/or speed from the fader position, press [Playback Options] from the main menu then press the select button of the playback.

Using the [Shape Size] and [Shape Speed] buttons you can set the shape size and speed to be fixed (how you programmed them) or to grow larger/speed up as the fader is pushed up.



When you use dimmer shapes, set the playback to [Shape Size on Fader] so that the shape fades in normally when you push up the fader. Otherwise the dimmer shape will start at full brightness when the fader passes the trigger point.

To set a fixed fade in time for the shape size, press [Edit Times] from the top menu, then the playback select button, then set the Delay/Fade times you want.

The Fade Mode allows you to set mode 0 (fade in), mode 1 (fade in and out) or mode 3 (crossfade). Mode 2 links fade times to the fader position, however we recommend you use the Playback Options listed above to do this for shapes, and do not use Mode 2.

If a new cue is fired which controls the same attributes (for example, a second shape controlling the same fixtures as a currently running shape), the new shape will crossfade from the running shape.

6.4 Pixel Mapper examples

6.4.1 Randomising effects

This example shows you how to use the pixel mapper to create an effect where random dimmer cells turn on. This effect will overlay any existing intensities.

- 1> The fixtures you want to use need to be recorded into a group, do this first if they are not already.
- 2> Adjust the layout of the fixtures in the group using [Shapes And Effects]/[Pixel Mapper]/[Edit Group Layout]/(select group).
- 3> Start creating an effect by selecting the group then [Shapes And Effects]/[Pixel Mapper]/[Create Effect].
- 4> In the Pixel Mapper Effect Editor window toggle the context menu option 'Fixture Overlay' until it reads 'Fixture Overlay 50/50'. (This will allow you to see the relationship of your fixtures to the effect as you create it.)

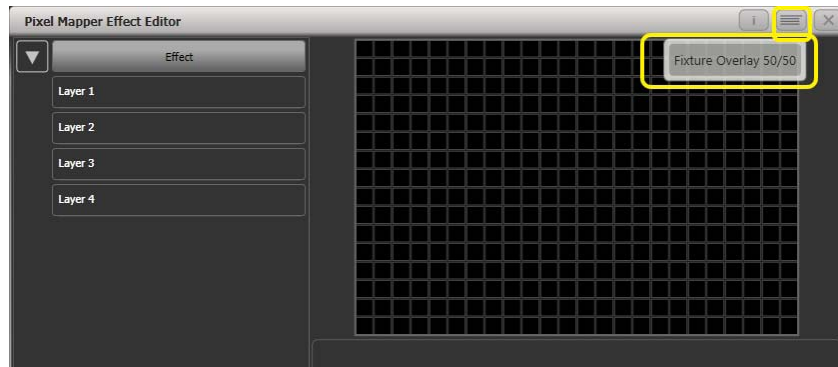

- 5> Select [Effect] and drag 'Background Opacity' slider to 0%. (This will allow the whole effect to overlay any related intensities.)

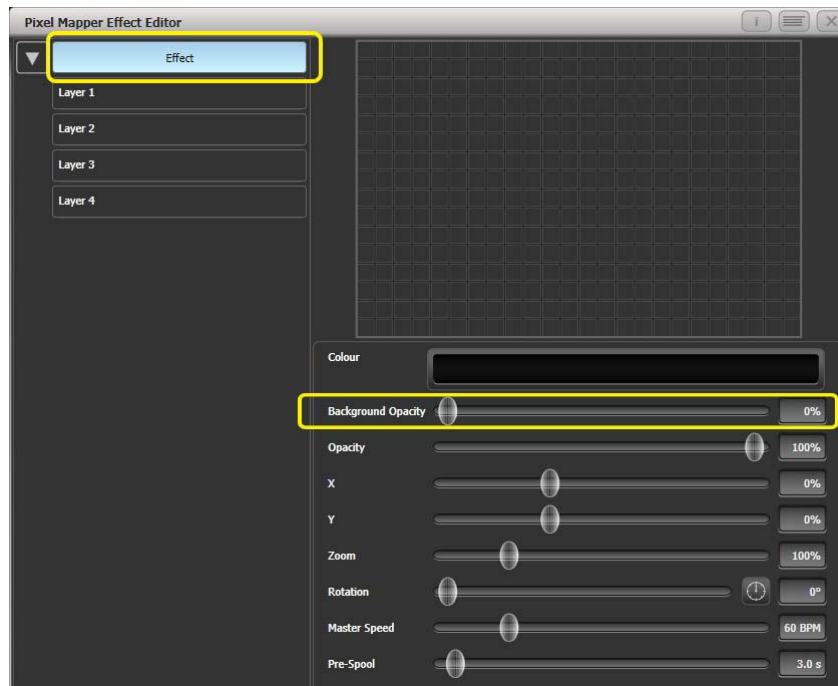

- 6> Select [Layer 1], click [+] at the bottom of the screen and then choose Circle from the elements that appear.

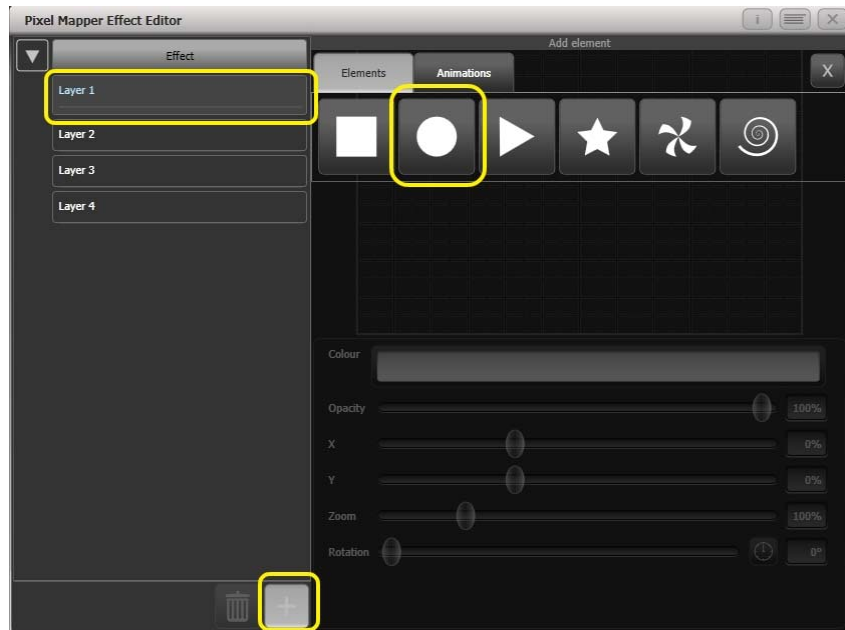

- 7> Drag the 'Zoom' slider until the circle covers approximately one cell. You can also use the 'Width' and 'Height' sliders to turn the circle into an oval if that helps. Then drag the 'X' and 'Y' sliders to position the circle roughly in the centre of your fixtures if it is not already.

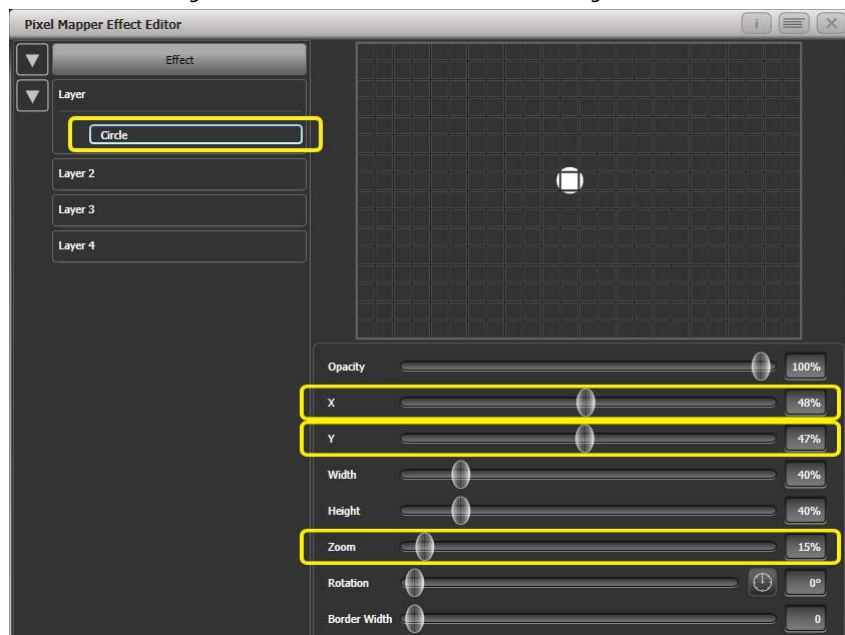

- 8> Select [+] again and choose Displacement from the animations that appear (this is represented as a few static blocks). (Note that nothing changes yet.)

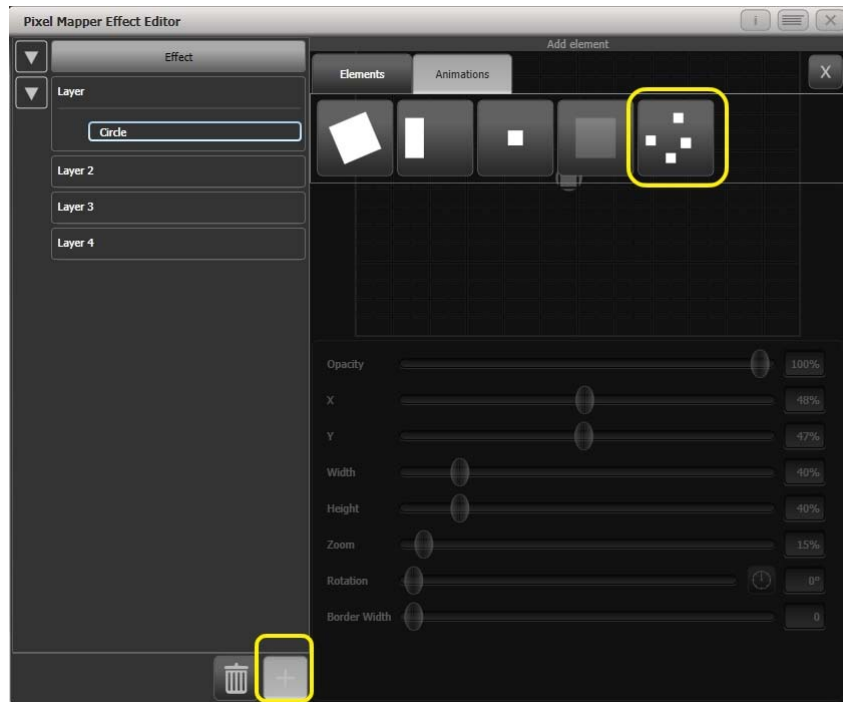

9> Select [+] and this time choose Opacity animation (represented as a block fading in).

The displacement acts on the opacity animation causing it to appear at random locations each time it is drawn.

Drag the 'In Time' and 'Out Time' sliders to 0%. (This will cause the effect to snap on/off instead of fade.)

Increase the 'Speed' and 'Spawn Rate' settings to make the effect run quicker and with more circles respectively. (High spawn rates are particularly useful for small randomised elements like this.)

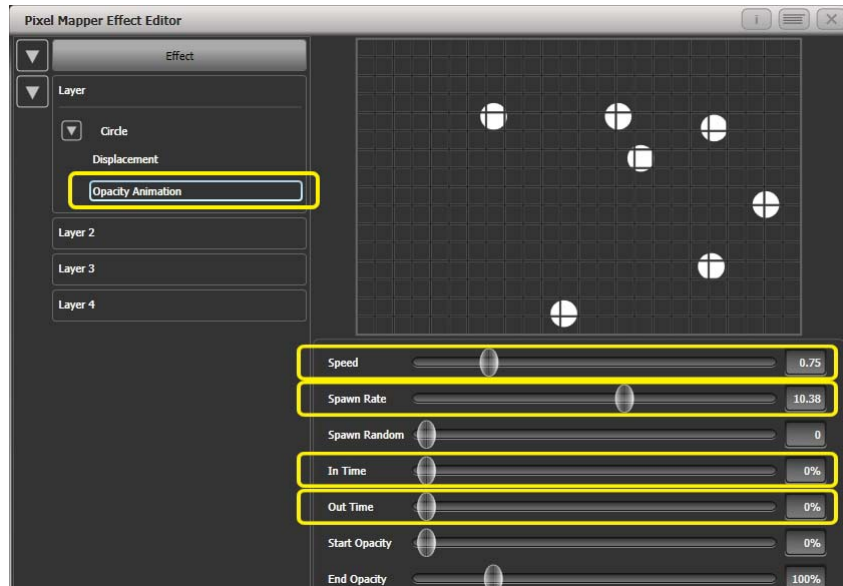

10> Record to a playback.

6.4.2 Overlaying effects

This example shows you how to create a diagonal white wipe with a rotating red fan on top.

- 1> Select a group containing a fixture layout as described in previous example.
- 2> Start creating an effect by selecting the group then [Shapes And Effects]/[Pixel Mapper]/[Create Effect]
- 3> Select [Layer 1], click [+] at the bottom of the screen and then choose Block from the elements that appear.

Drag the 'Rotation' slider to the right to angle the element at approximately 25 degrees.

Drag the 'Width' slider to the left to make a thinner block.

Drag the 'Height' slider to the right until the block fills the height of the entire window.

Drag the 'X' slider to the right until the block is just off the screen.

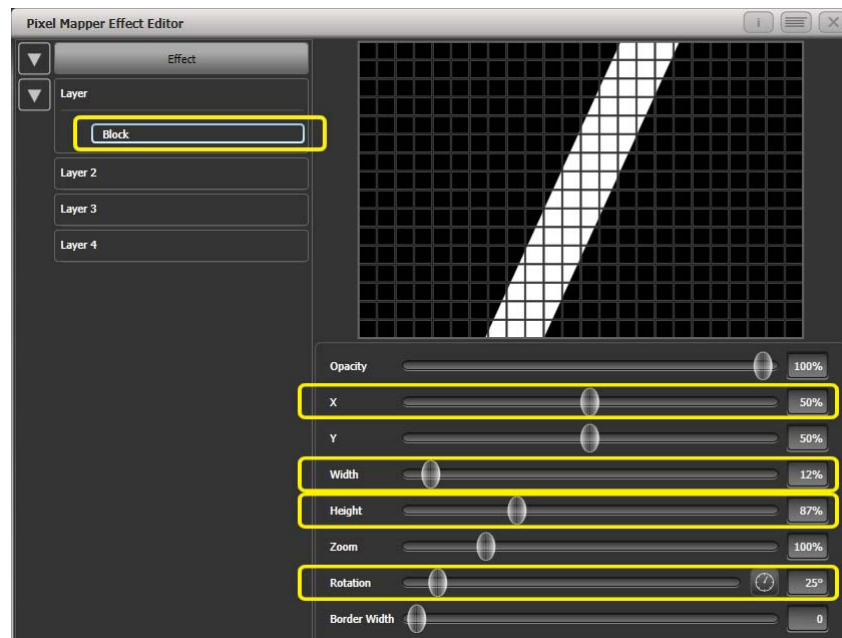

- 4> Click [+] again and choose Linear Movement animation (represented as a block moving left to right).
On the right side of the 'Direction' slider there is a compass button. Click on this four times until the direction reads 270 degrees. (By default the animation is set to 90 degrees or left to right. Because we placed the block on the far right of the screen we want it to move the other way. The compass gives shortcuts to the more common directions in 45 degree increments.)

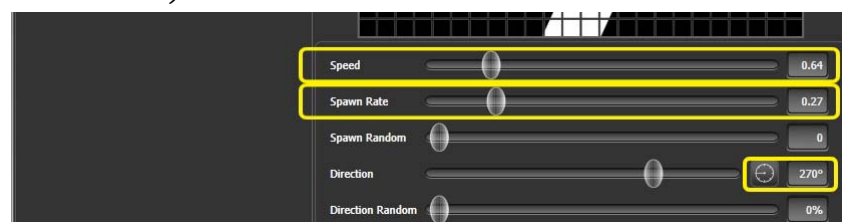

Reduce 'Spawn Rate' until only one stripe is on screen the same time. For this type of effect the value will usually need to be quite low - approximately 0.2.

You might want to reduce 'Speed' slightly at this point. (Note that a higher speed was initially useful for getting the correct spawn rate above.)

- 5> Click on [Layer 2], select [+] and select the Swirl element (represented by a 'fan' shape with four arms).

Increase 'Zoom' until it is as large as will fit in the screen.

Set 'Bend' to 0% for nice straight fan blade edges.

Set 'Points' to 3 (minimum) for a three bladed fan.

Set 'Thickness' to 50% for evenly sized segments.

Increase 'Border Width' to a low value so that we just have an outline.

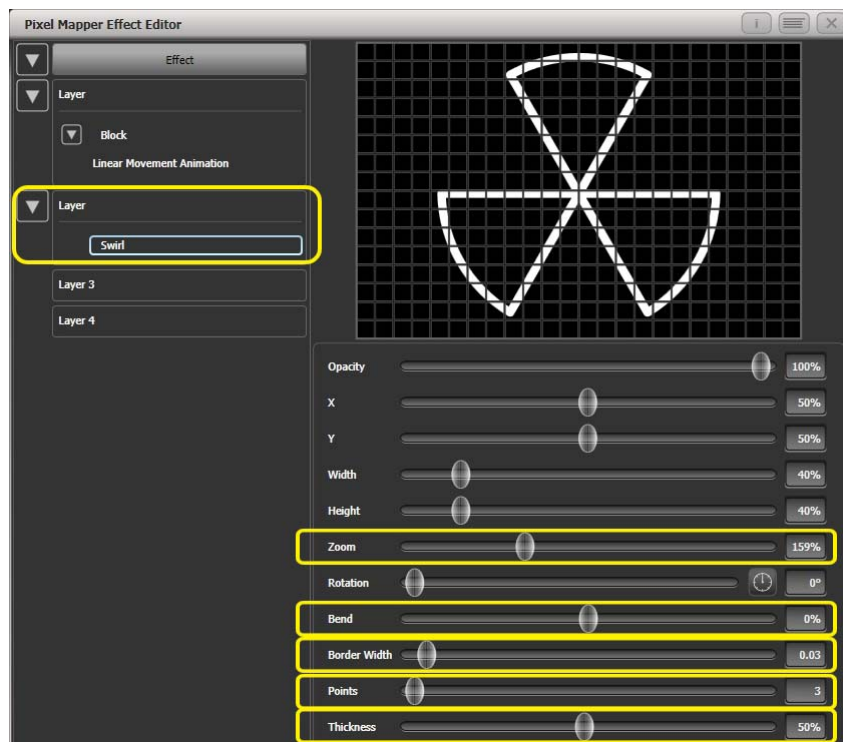

- 6> Click on [+] and add a spin animation.

Reduce the speed until it just causes a light breeze.

- 7> Click in the top of this layer to get the layer controls.

Click on the colour bar to open the colour picker.

Click and drag to the top left of the picker window to get a strong red.

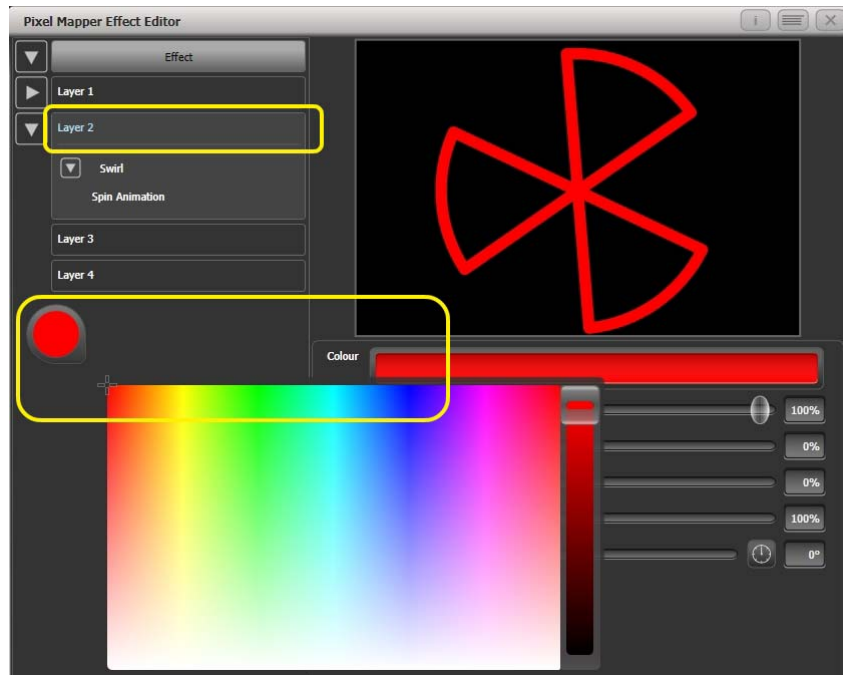

- 8> Click on [Effect] at the top left to access the global controls. Drag 'Pre Spool' to the left until it reads 0s. (This is to ensure the wipe begins off screen where we placed it when it is fired.)
- 9> Record the cue.

- Note how the red fan sits on top of the white bar when they interact. This is because the white is on a lower layer. A higher layer number has priority over a lower number.



6.4.3 Creative use of fixture layouts

Because each fixture group can contain a different layout it is possible to create more than one arrangement of the same fixtures for pixel mapping.

By arranging fixtures in certain layouts you can easily achieve complex effects.

Example 1: Odd/Even

- 1> Select your fixtures.
- 2> Open the Selection Pattern menu by pressing the 'All' key.
- 3> Choose [Odd] from the softkey options. (This will select all the odd numbered fixtures according to fixture order.)
- 4> Record a group.
- 5> Press '+1' (or 'Next') key. (This will select all the even numbered fixtures.)
- 6> Merge this into the first group.
- 7> Open the Layout Editor. ([Shapes And Effects]/[Pixel Mapper]/[Edit Group Layout]/(select group).)

By doing the above you should be able to see how we have quickly created a layout where the all the odd fixtures are arranged together on the left followed by all the even fixtures on the right.

This arrangement could be used as it is. A block element animated to run horizontally left to right will run across all your odd fixtures followed by all the even fixtures.

An alternative goal might be a vertical 'cascading' effect:

- 1> Click on the vertical resize tool and drag down until the grid is at least twice the original height.

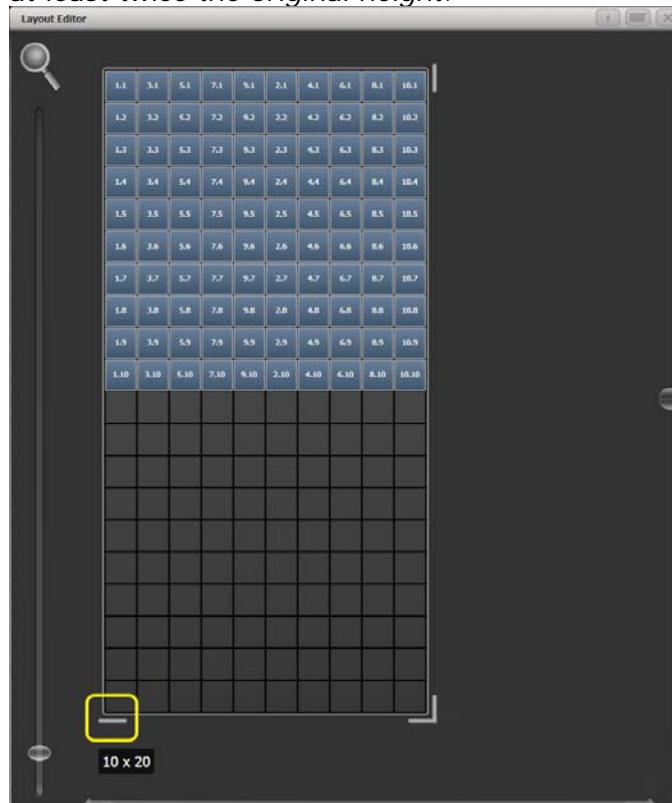

2> *Drag a marquee select across the even fixtures.*

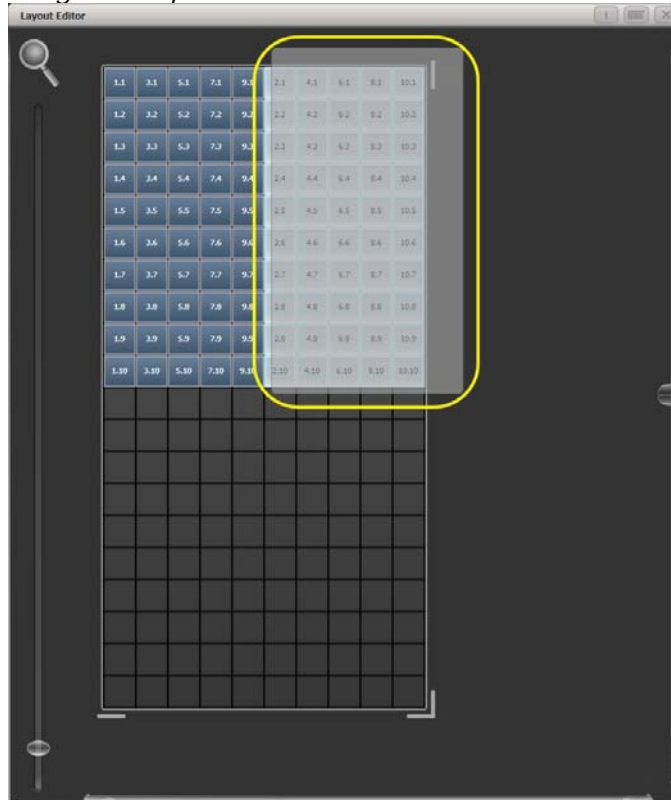

3> *Drag the selected fixtures so they sit directly under the odd fixtures.*

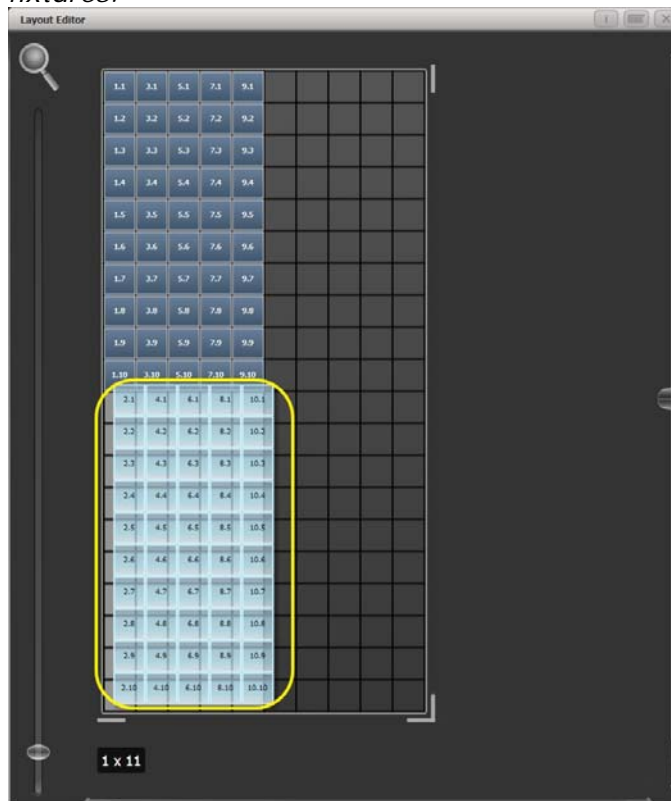

4> *Select 'Crop Grid' from the Layout Editor context menu. (This will get rid of the unused pixels.)*

Now a block element animated to run vertically from top to bottom will run down the odd fixtures followed by the even fixtures.

Example 2 - Pseudo random

- 1> *Select your fixtures and create a group.*
- 2> *Open the Layout Editor.*
- 3> *Click on the vertical resize tool and drag down until the grid is at least twice the original height.*
Note that to help with creation and manipulation of larger grids you can use the zoom control on the left-side of the window. Clicking on the magnifying glass gives a quick shortcut to zoom in/out.
- 4> *Select the group again. (This will quickly select everything in the layout.)*
- 5> *Press '+1' key. (This will select the first fixture.)*
- 6> *Use the wheel to adjust 'Position Y'.*

Repeat steps 4 and 5 until all the fixtures are at different heights in relation to one another.

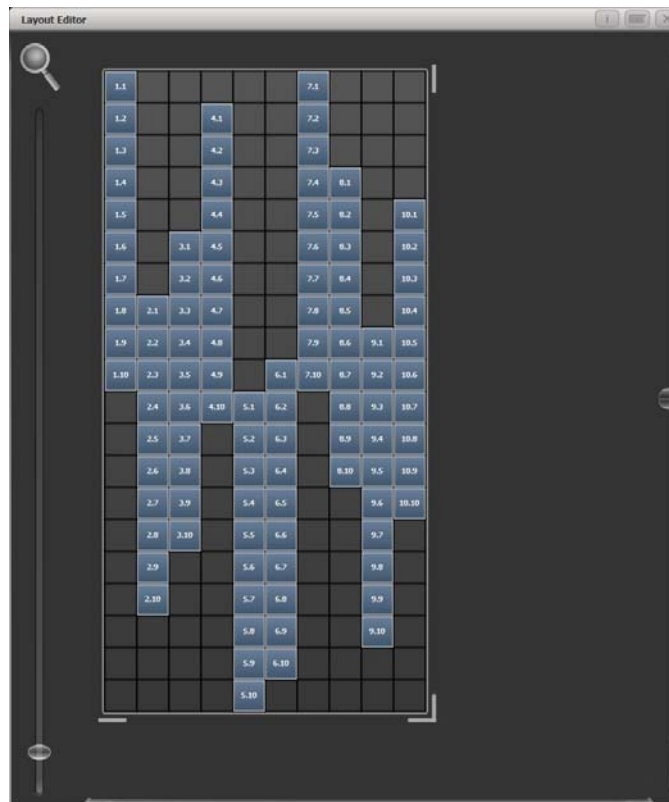

If you create an effect using this group it will appear to be random. Adjustments can be made to the layout at any time to fine-tune the end result.

Example 3 - Angles (or 'when straight just isn't good enough..'):

Sometimes we like to hang fixtures at artistic angles to look pretty. By default the software assumes you have hung them vertically but fear not - Titan has a solution:

- 1> *Select your fixtures and create a group.*

- 2> *Open the Layout Editor.*
- 3> *Select the fixture(s) that you want to angle and use the appropriate wheel to control. (If wheels are not assigned to control the cell layout you can toggle this on/off using the context menu item 'Wheel Control'. Also, on the Pearl Expert you may need to select 'Adjust Angle' and to return wheels to controlling position select 'Adjust X,Y'.)*

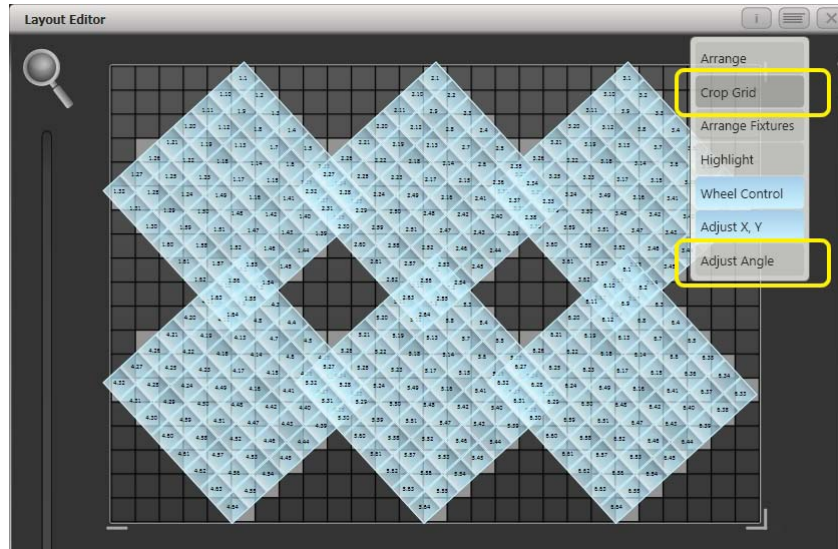

Note that underneath the visual representation of the fixtures the actual cells used are shown in light grey.

If any of your fixtures have been naughty and ended up beyond the bounds of the grid after rotating you can use context menu item 'Crop Grid' to make them behave.

6.4.4 Other Layout Editor tools

The Layout Editor's context menu has some useful tools for laying out fixtures quickly.

Context menu - 'Arrange Fixtures'

This is a very useful tool to quickly layout fixtures in a grid. For example you might have 20x Colourblocks across four towers, each with five blocks.

- 1> *Select the fixtures and create a group.*
- 2> *Edit the layout of this group.*
- 3> *Select 'Arrange Fixtures' from the context menu.*
- 4> *Select the [Height] softkey and type '5'. (Width will automatically be calculated.)*
- 5> *Toggle [Crop Grid to fixtures] so that it is highlighted. (This will make the grid adjust to fit.)*
- 6> *Toggle [Arrange in..] to 'Columns' or 'Rows'. 'Rows' will arrange fixtures left to right and 'Columns' will arrange top to bottom.*
- 7> *Select [OK] to complete.*

Context menu - 'Highlight'

When enabled this will highlight selected fixtures live on stage. This can be useful to see which fixture you are positioning in the layout.

Context menu - 'Arrange/Select Only'

When set to 'Select Only' fixtures are locked in position on the grid and cannot be dragged around. This provides an alternative way of selecting fixtures to edit while preventing accidental movement.

If you find you suddenly cannot move anything around this is probably the reason!

Note that X,Y and Angle wheel control is still available.

6.4.5 Playback Order and Priorities

Suppose you wished to create a white pulsating oval on one playback and a blue spiral on a second playback. Normally these effects would layer differently depending on the order you fire the playbacks, but you can use playback priorities to make them always layer the same way

To create first effect:

- 1> *Select a group containing a fixture layout as described in previous example and go to [Create Effect].*
- 2> *Select [Effect] to access the global effect controls and change 'Background Opacity' to zero. (This will allow it to overlay the other playback.)*
- 3> *Double-Click [Layer 1] (or press [+]) and choose Circle from the elements that appear. (Double-click is a shortcut to elements and animations.)*
Reduce height to make a rugby ball (or American football if you insist).

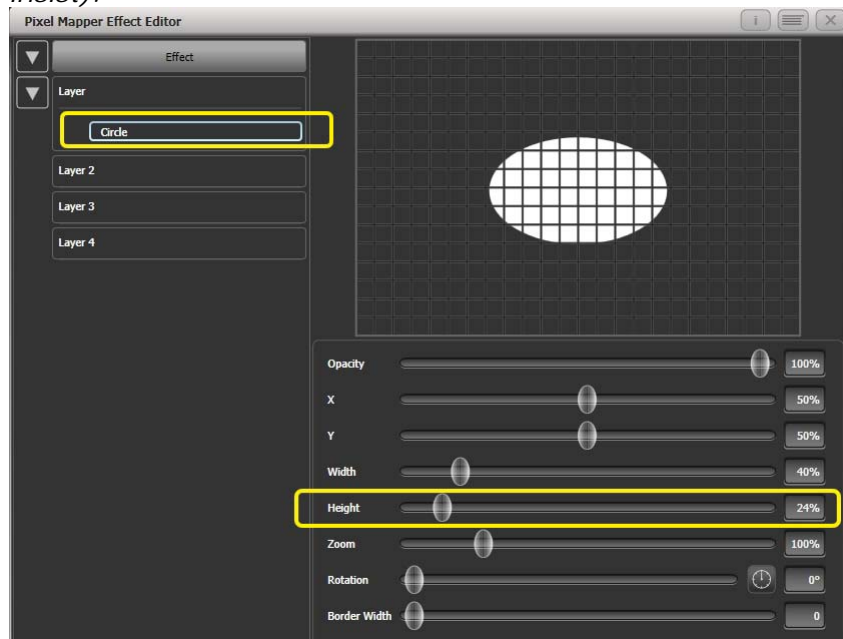

- 4> *Double-click on [Circle] (or press [+]) and select the Zoom animation.*

Drag 'In Time' to zero and 'Out Time' to 100%. (This will make the effect start large and finish small. Alternatively the same effect can be created by making 'Start Zoom' larger than 'End Zoom'.)

Increase 'End Zoom' until the element begins by filling the whole window.

- 5> Double-click on [Zoom Animation] (or press [+]) and select the Opacity animation.

Reduce 'Spawn Rate' to zero. (This will ensure the opacity only works on the zoom animation.)

Drag 'In Time' to zero and 'Out Time' to 100. (This will make the effect snap on and fade out as it reduces in size. As with zoom you can achieve much the same thing by inverting the opacity controls instead. Using opacity values greater than 100% will create a delay before fade.)

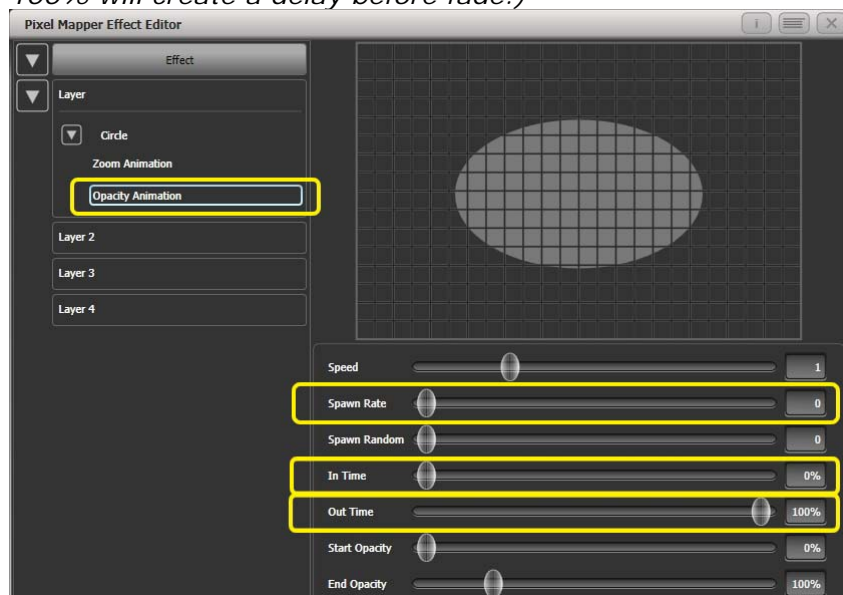

- 6> Click on [Effect] again and reduce 'Master Speed' to your preference. (Adjusting the global speed control ensures the zoom and opacity animations are synchronised instead of

having to manually match the individual values.)

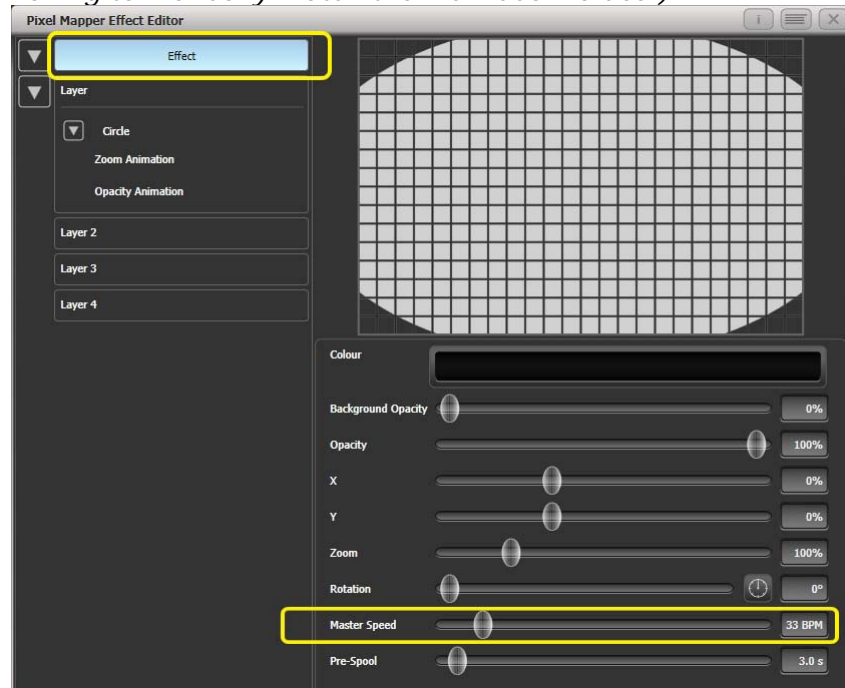

7> *Record the cue.*

Next we will create the second effect:

- 1> *Select the same group as used for the first effect and [Create Effect]*
- 2> *Select [Effect] and change 'Background Opacity' to zero.*
- 3> *Select [Layer 1] and this time add a Spiral element.
Increase 'Zoom' so that it's nice and big.
Drag 'Thinning' until it is at 0%. (This will make the lines of the spiral stay the same width. A negative value means the spiral gets thinner towards the outside; a positive value means it gets thinner towards the inside.)
Reduce 'Turns' so we can make a more bold effect. Approx. 3 should work.
Increase 'Thickness' to 50% for chunky lines.*

Increase 'Exponent' to around 25%. (This causes the spiral to 'expand' at a faster rate.)

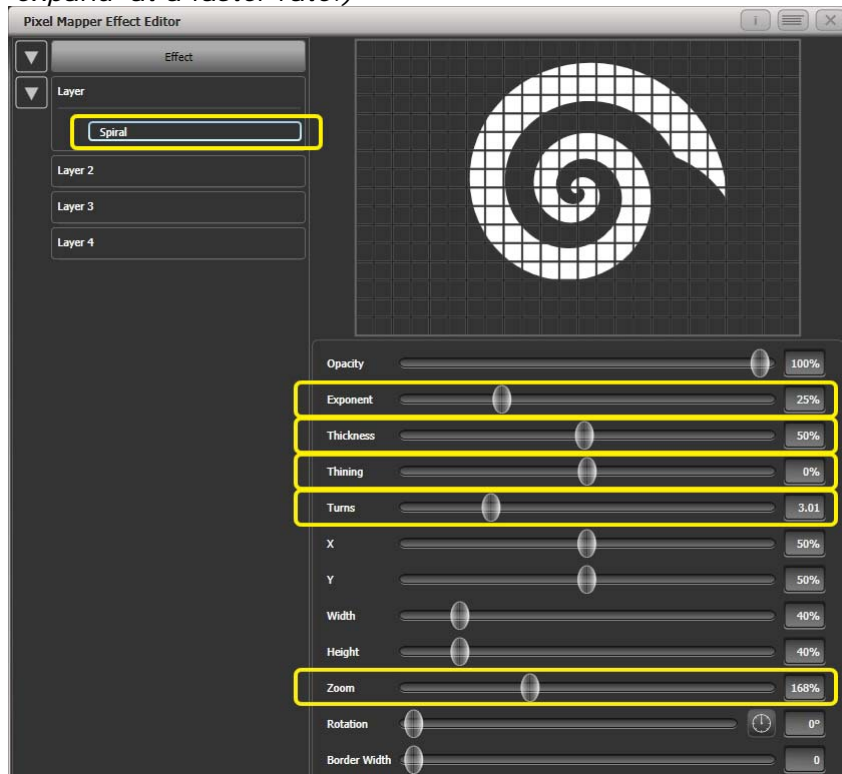

- 4> Add a Spin animation for genuine psychedelic effect. Adjust speed until you are unable to look away from the screen.
- 5> Select the Layer to show the layer controls and change the colour to blue using the colour picker.

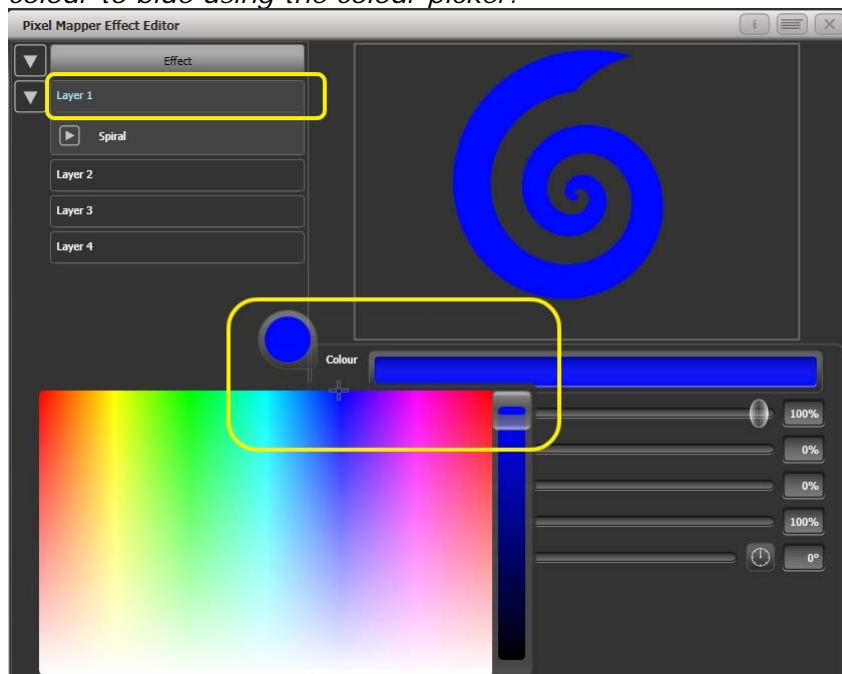

6> Record the cue.

Now let's look at how they interact on the playbacks:

- Fire the blue spiral effect.

- Fire the white pulse.

Notice how the white takes priority over the spiral. The blue spiral only appears as the white oval fades out and gets smaller.

- Kill both effects.
- Fire the white pulse.
- Fire the blue spiral.

This time the blue spiral sits on top of the white pulse. That is because the playbacks are following a 'latest takes precedence' rule (LTP).

To guarantee the blue spiral always sits on top you can set it to be a higher priority:

- Kill both effects.
- [Playback Options]/Select the blue spiral playback.
- Press [Previous] or [Next] until you can see [Priority Normal] on the softkeys. Press this to toggle it to [Priority High].
- Now fire the blue spiral followed by the white pulse.

Even though you fired them in the same order as the first example the blue spiral now sits on top of the white pulse because it has a higher priority.

6.4.6 Displacement and Layer Properties

In this example we create random flashing bars, and use layer controls to make global adjustments to the whole effect.

-
- 1> *Create a group and adjust the fixture layout as described in previous examples.*
 - 2> *Select this group and begin creating an effect.*
 - 3> *Select [Layer 1] and add a 'Block' element.*
 - 4> *Adjust the width and height sliders until we have a thin strip that covers at least one cell vertically and the whole grid*

horizontally.

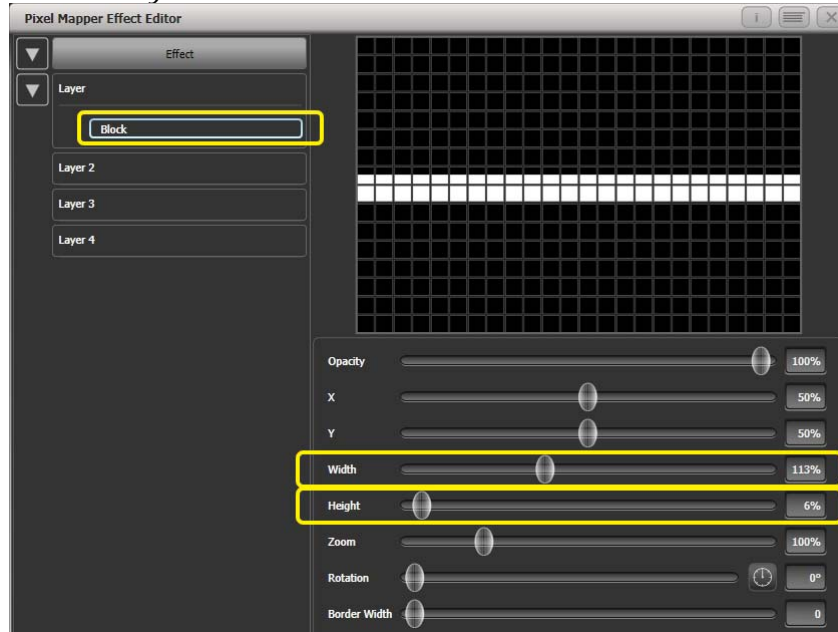

- 5> Reduce Y until the bar disappears off the top of the grid. (This is in preparation for adding a displacement animation.)
- 6> Add a Displacement animation. By default this will offset the original position by anything up to 30% distance. This is because the default value for 'Distance' is set to a maximum of 30% and 'Distance Random' is set to 100% meaning it can use any random value between zero and 30%. Similarly 'Direction Random' is set to 100% meaning it can offset in any direction. Temporarily set 'Distance Random' to zero. (This is in order to see exactly what the displacement is doing.)
- Set 'Direction Random' to zero. (In this example we do not require a random direction.) Now the bar will disappear because it is being displaced upwards in the default settings.
- Set 'Direction' to 180 degrees. Click on the compass button four times to get there quickly. Now the bar should reappear on the screen because it has been offset vertically down from the our off-screen position by the default 30%.
- Increase 'Distance' until the bar is approximately in the centre.

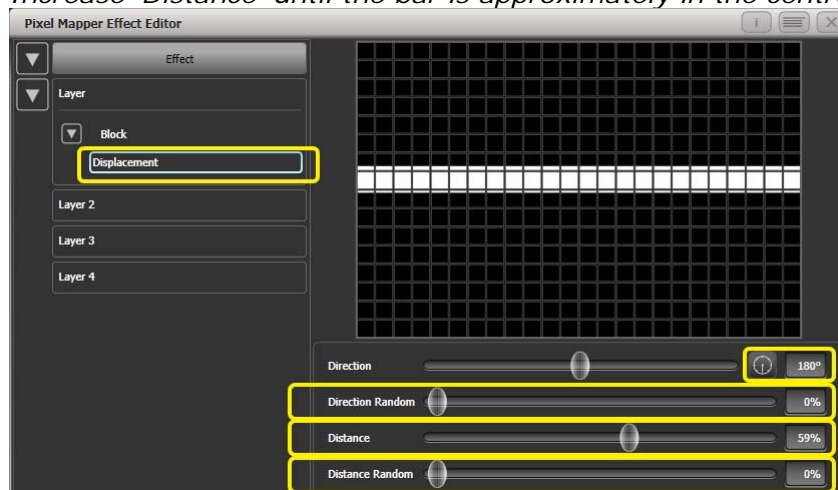

- 7> Add an Opacity animation.

Reduce 'In Time' and 'Out Time' to create a snapping effect.

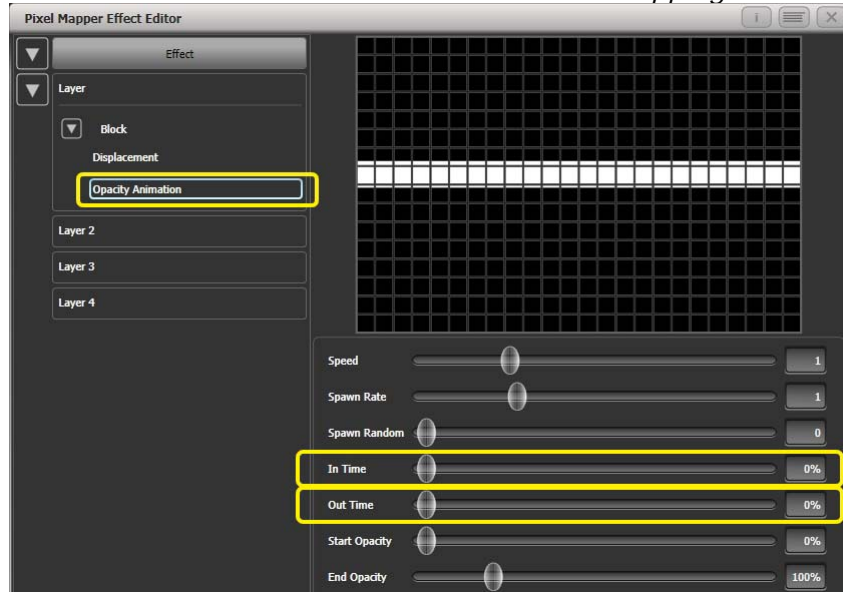

- 8> Click on 'Displacement' in the Layer to get back to the controls for this animation again.

Now increase 'Distance Random' to 100%. (This will make the bar draw at a random offset around the 'Distance' setting, in this case making it anywhere within the grid.)

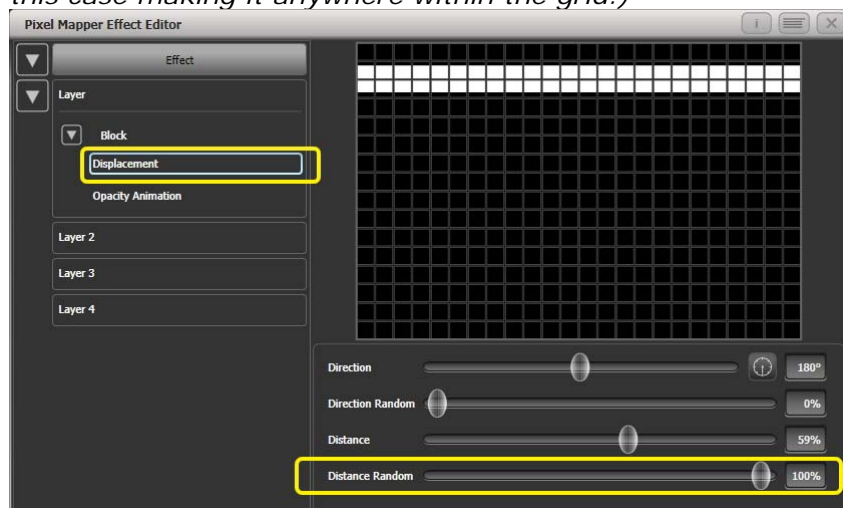

- 9> Return to the Opacity animation controls and increase speed until you're happy.
- 10> At this point you may decide actually the effect would be better if it was a vertical bar. To make this easy we can make adjustments on the layer controls rather than on the individual element and animations:

Select [Layer 1] to bring up the layer controls.

Change 'Rotation' to 90 degrees by clicking on the compass button twice.

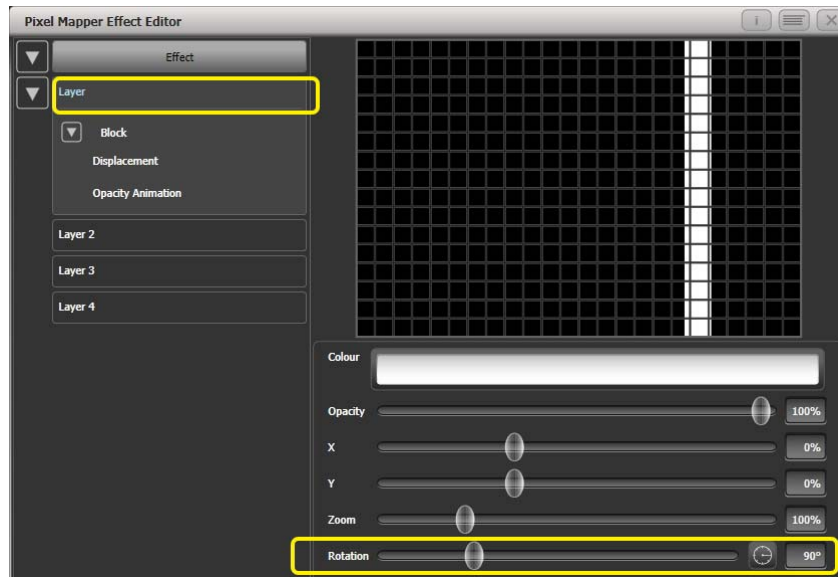

Now you have a vertical bar that draws randomly using a horizontal displacement. Similarly you can use the [layer] or [effect] controls to make global changes to X/Y position and Zoom allowing quick manipulation of entire effects.

6.4.7 **Spawn and Pre-Spool**

The director has asked for lots of animated spinning shurikens that slowly move across a backdrop while pulsating. It is a mystery why, but you know how it is with directors.

-
- 1> *Select a group with an appropriate layout.*
 - 2> *Add a Star element.*
Change 'Points' to 4 for a classic shuriken.

Reduce 'Zoom' so that we can fit lots of baby shurikens in the grid.

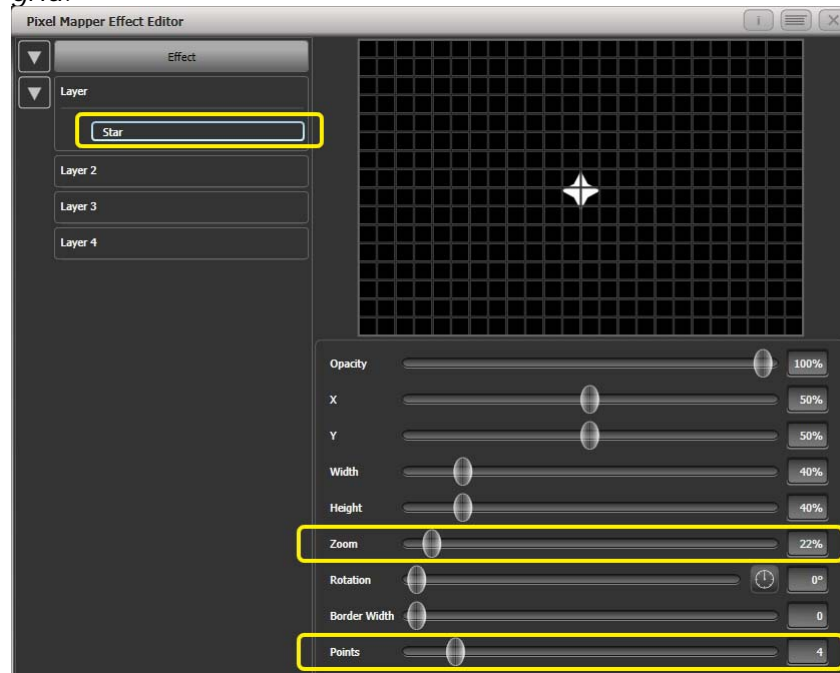

- 3> Add a Spin animation.
Reduce 'Speed' so they are relatively harmless.
- 4> Add a Linear Movement animation.
Slow it down so it looks like it is rolling along.
- 5> Select the Star element again and change 'X' so the shuriken starts further from the left and rolls along the whole grid.

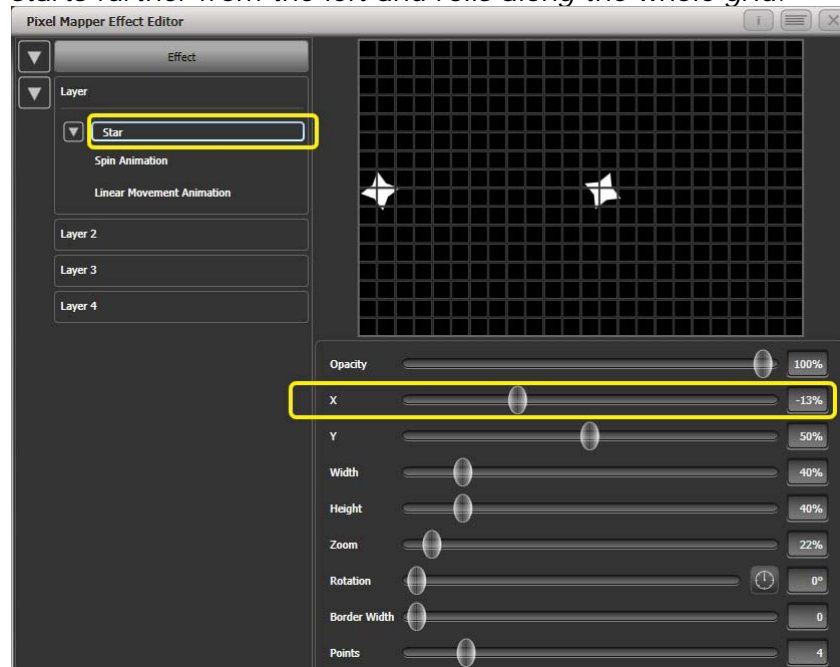

- 6> Add a Displacement animation.
Now each new shuriken starts rolling at a different height on the grid.
- 7> Go back to the Linear Movement animation and increase 'Spawn Rate' so that more shurikens are on screen at once. (This determines how frequently a new element appears.)

Increase 'Direction Random' slightly. (This will allow a random variation in the direction of travel based upon the 'Direction' value.)

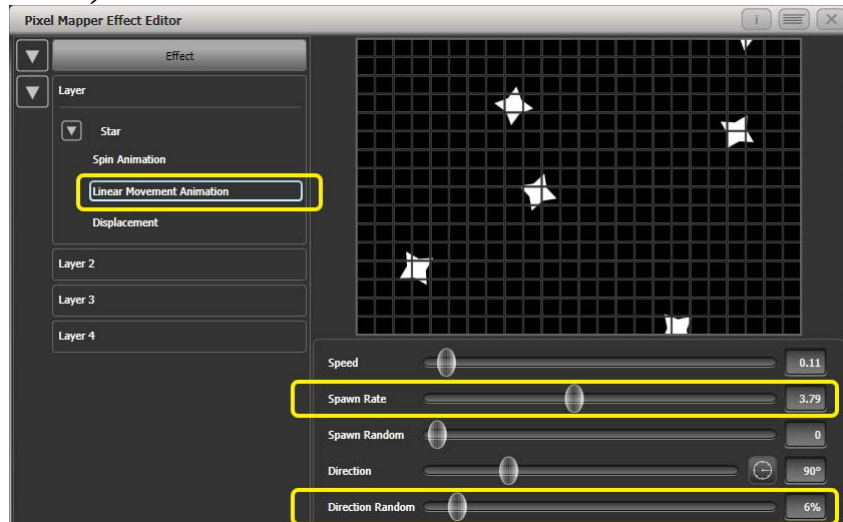

8> Add a Zoom animation.

Reduce 'Spawn Rate' to zero. (This is a special setting that will allow the zoom animation to run continuously during the life of a shuriken. If the rate is set to 1 it will only run once and the shurikens will quickly disappear as a result.)

Increase 'Out Time' to 100%. (This will make the shurikens pulse in and out with a 'bounce' type effect. I have no idea why they would be doing this in reality.)

Slow the zoom down a bit.

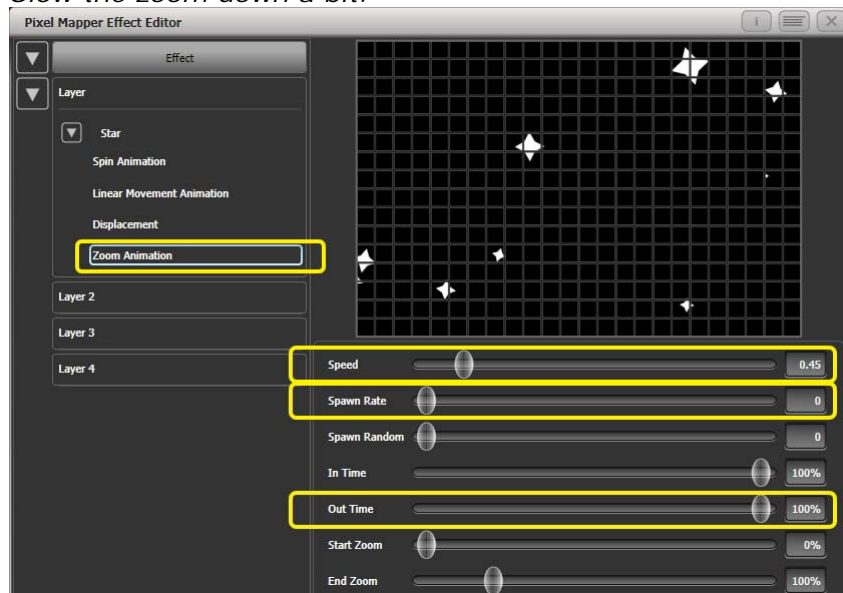

- 9> Click on [Effect] and set 'Pre-Spool' to zero. (This is to demonstrate the purpose of the property.)

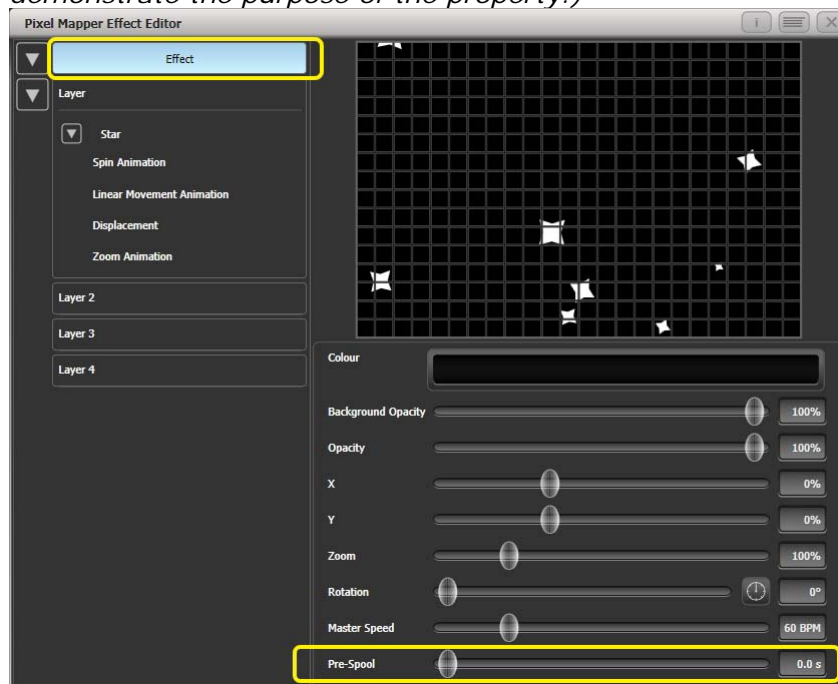

- 10> Store the cue.
- 11> Press clear, open the Pixel Mapper Preview workspace and fire the cue.
 You will notice that initially there are no shurikens on the screen and it takes a while to build up to a nice random collection. To fix that we can use 'Pre-Spool'.
- 12> Include the cue and open the Effect Editor workspace if it is not already.
- 13> Select [Effect] and increase the 'Pre-Spool' value to around 20s. (This means the software will pretend 20 seconds has already elapsed when the effect is started.)
- 14> Store the cue, clear, fire and view again in the Pixel Mapper Preview.

This time there should already be plenty of shurikens on screen. Pre-Spool is particularly useful for animations that rely on high spawn rates but run at a low speed.

7. Cues

So you've set up a great look on the stage, and you want to save it to use in your show.

There are three ways of saving looks on the Tiger Touch.

Cue: This is a single look. It may contain movement in the form of shapes, and have fade in and fade out times.

Chase: This is a timed sequence of cues, often used for an individual effect.

Cue List: This is a linked sequence of cues, usually used to store and replay an entire show or an element of a show from a "go" button.

Cues, Chases and Cue Lists are all stored in the playback faders at the bottom left of the console. Chases and Cue Lists are covered in the following chapters.

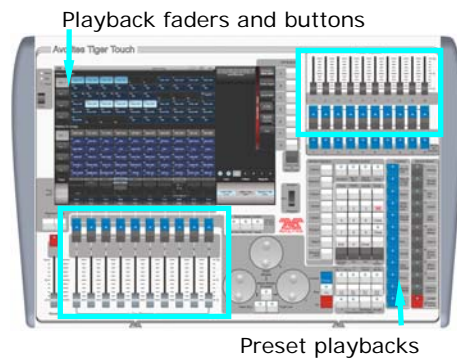

The Tiger Touch has 600 playbacks, in 60 pages of 10. In addition, you can store 10 'preset' playbacks on the faders at the top right of the console. There are no page buttons for these faders, so the 10 playbacks stored there are always available.

Also, you can store cues in touch buttons in the Playbacks window, provided you don't need a fader.

The cue functions on the Tiger Touch are very powerful; the first part of this section explains the basics of how the console uses cues.

7.1 Creating a cue

7.1.1 How the Tiger Touch works when programming

When you select one or more dimmers or fixtures for control, they are loaded into the *Editor*. You can then use the wheels and palettes to change the settings on the fixture. You can also apply shapes to it.

If a fixture is selected after you have changed some attributes then the current list of fixtures in the Editor is emptied and a new list is started.

All fixtures and attributes that have been edited since the last Clear are stored in the *Programmer*. The order in which you selected the

fixtures is also stored, and is used with the Fixture Overlap function. When you record a cue, the contents of the Programmer are saved into the cue.

When you press Clear (by the numeric keypad), the programmer and editor are emptied. This makes sure you don't record fixtures you don't want. You also need to press Clear when you finish programming, because any attributes in the programmer will override playbacks.

Fixtures which are in the programmer are shown in mid blue on the HUD windows and on the touch buttons. Attributes in the programmer (the things you have changed) are shown in cyan on the HUD windows and attribute displays.

Firing a cue does not place the values from the cue in the programmer (although the Include function lets you do this, see section 7.3.4 on page 131).

7.1.2 **Creating a cue**

- 1> *Press Clear to clear the programmer. This ensures that you are starting with a clean slate.*
 - 2> *Set up the look using the fixtures. You can save shapes in a cue. Remember that only fixtures which are selected or have been modified will be saved in the cue (in Record by Fixture mode).*
 - 3> *Press the Record Cue button.*
 - 4> *Press the Swop button of an empty Playback to record the cue. The handles where you can record the cue will flash. You can also record a cue onto a touch button in the Playbacks window.*
 - 5> *Press Clear to clear the programmer. Repeat from 2 to program more cues.*
-

Other useful things to know about recording cues:

- Cues can be recorded into the playback faders, the 10 fixed playback faders on the top right and the onscreen Playbacks window.
- [Record Mode] lets you select Record By Fixture (all attributes of any modified or selected fixture are saved), Record By Channel (only modified attributes are saved), Record Stage (all fixtures with a non-zero dimmer channel are saved) or Quick Build (see next section).
- Record By Channel is useful if you want to layer multiple cues to create an effect.
- If you are recording a lot of cues, you can press the Menu Latch button to keep the Record Cue menu active. Press Exit to leave Record Cue mode.
- The touch screen immediately above each fader shows a legend for the playback. To set this, press [Set Legend], then the playback Swop button (or the touch select button), then enter a legend on the keyboard. Press Enter to store it.

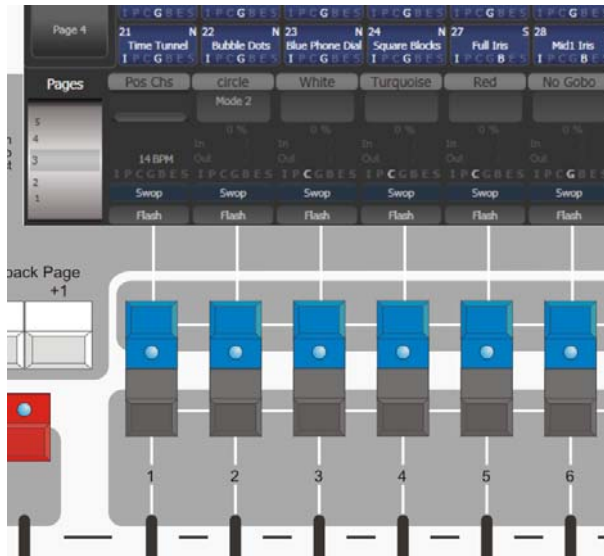

7.1.3 Quick Build cues

Setting [Record Mode] to Quick Build allows you to build a cue from existing playbacks or palettes (you can also use the Include function to do this).

After setting the record mode to Quick Build, the console will wait for you to select playbacks or palettes.

To insert specific fixtures from a palette or playback, select the fixtures first and then select the palette or playback.

Press [OK] once you have selected all the playbacks or palettes required.

7.1.4 Using shapes/effects in cues

As you would expect, any shapes or Pixel Mapper effects you have set up will be saved as part of the cue.

You can create a cue which contains a shape with no base reference values; a shape cue like this can then be fired with other cues to overlay the shape on the cue and give you instant effects based around the settings in that cue. When recording the cue, use the "Off" function to remove the other attributes from the programmer as described on page 133.

7.1.5 Blind mode

Blind mode allows you to program cues without affecting the current look on the stage. This can be very useful for making changes during a live show. Your changes are still shown in the Visualiser window.

To select Blind mode, hold down the Avolites button and select the [Blind] option. The option shows [Active] or [Inactive].

Individual playbacks can be set to Blind mode using [Playback Options]. The playback will then output only to Visualiser, not to the stage.

7.2 Using a cue

Because it's possible to play back a large number of cues at the same time, the console has to have rules on how it combines the output from different cues. These are called HTP and LTP rules.

7.2.1 HTP and LTP

Control channels are handled in two ways:

- Dimmer or intensity channels work on the principle of "Highest Takes Precedence" (HTP). If an HTP channel is active at different levels in several cues, the highest level will be output. When you fade out a cue, the HTP channels fade out with it.
- All other channels work on the principle of "Latest Takes Precedence" (LTP). The latest change takes over from any other values, so the most recent cue to be turned on is the one which is output. When you fade out a cue, LTP channels retain their values until changed by another cue.

7.2.2 Playing back a cue

To fire (play back) a cue, raise the fader. (Make sure there are no values in the programmer by pressing the Clear button, because anything in the programmer will override the playback).

- You can fire several cues at once.
- The HTP levels in the cue will be mastered by the fader level; for example if you set the fader at 50% then all HTP levels will be 50% of their programmed values.
- LTP channels are triggered as soon as the fader goes above 0%. If a fade time is programmed the LTP channels will start to fade; if there is no fade time they will snap to position (unless the cue is set to Mode 2; see the timings section 7.5 on page 135 for details of modes).
- You can Flash the cue by pressing the grey flash button. You can Swop (solo) the cue by pressing the blue Swop button (all other active cues will turn off while the button is pressed). This assumes you haven't reassigned the function of the buttons using Key Profiles, see below.
- You can Preload the cue by assigning the Preload function to the blue or grey buttons using Key Profiles. Preload sets the attributes of fixtures in the playback which are not currently active in any other playbacks. This is useful to avoid the fixtures visibly moving into position or changing colours or gobos when you raise the fader of the cue. To assign Preload, hold Avo Shift and press [Edit Key Profile], then press the button you want to assign (also see section 12.3.4 on page 195.) Note that this will assign the function to all buttons of the same type.

7.2.3 Changing playback pages

You change playback pages using the +1 and -1 buttons to the left of the playback faders. You can also touch the 'Pages' roller graphic and enter a page number.

If you have stored cues on the touch select buttons, you select different pages using the Playbacks page touch buttons.

- Playbacks which are fired when you change page remain active. If you want to fire a cue on a fader which is already on from a previous page, lower the fader to zero then raise it again. The cue from the previous page will stop and the cue from the new page will fire.
- If you return to a page with an active playback, the fader will not resume control of the playback until it matches the current level of the playback. This prevents the playback level “jumping” when the fader is first moved.
- You can set a legend for each playback page. The legend is shown on the ‘Pages’ roller on the screen and on the HUD. Use [Set Legend] from the main Program menu then [Page Legends]. While in this menu you can change the page to set legends for different pages. The 10 static playbacks on the top right of the console can be paged using two of the macro buttons. The page change macros are part of the fixture library; if you do not see the macros, download and install the latest library.

7.2.4 Viewing active playbacks

The Active Playbacks window shows details of which playbacks are active. This provides an easy way to see what is currently running, which page they are from and which attributes are affected. To show the window press View, [Open Workspace Window], [Active Playbacks].

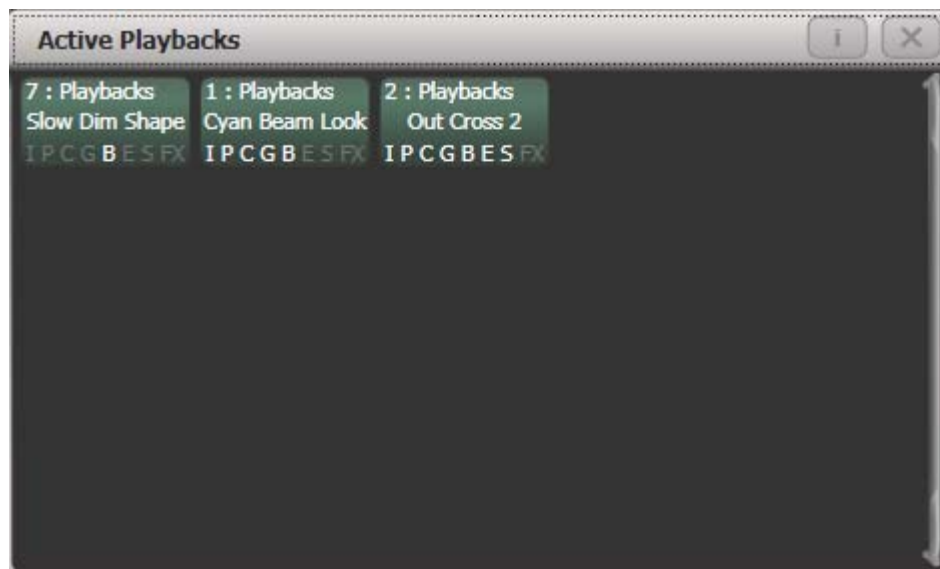

Click on a playback to instantly kill it. You can also press [Playback Options] followed by the playback in this window to change parameters of the playback.

7.2.5 Speed Masters

Playbacks can be assigned to a Speed Master which allow you to modify the speed of shapes or effects stored in a cue (or in the case of chases, to modify the speed of the chase).

A playback is assigned to a Speed Master by pressing [Playback Options] then [Speed Source]. The following speed sources are available:

- Local (no Speed Master)
- BPM 1-4 (override the local speed with a fixed value from the master)
- Rate 1-4 (proportionally modify the local speed using the master)

The 4 different BPM Masters and 4 different Rate Masters allow you to individually control the speed of different playbacks.

You will also need to assign one or more handles to act as the master faders; to do this, switch the console to System mode and select [Assign Mastering]. Special key profile options are available for Speed Masters, BPM Masters default to Tap Tempo.

7.2.6 Releasing running playbacks

You can release a running playback to its previous state by pressing the Off button, then the Select button of the playback to be released. Channels will release back to their state in the previous playback until no playbacks are left to be released, at which point they will go to the power-on state. You can release all running playbacks by pressing the blue Off button then [Release all playbacks].

You can also configure the key profile so that the blue or grey buttons can be used to release the playback.

Channels will always release with a fade time, this defaults to 2 seconds but you can change it using Master Release Time in the User Settings menu (see section 12.3.3 on page 194).

- You can instantly kill a playback by pressing Avo+the swop button of the playback.
- You can set a mask to automatically release channels from the playback when the playback is killed. This uses the [Release Mask] option in the Playback Options menu (see section 7.6.1 on page 139). Normally all attributes will remain in the state last used in the playback.

7.2.7 Turning off individual fixtures/attributes in playbacks

You can turn off fixtures/attributes and remove fixtures from shapes in playbacks.

Press the softkey [Off Playback Values] followed by a playback to open the 'Off Playback with Mask' menu. Select the fixtures to be turned off, set mask as required and then press [Off] to turn the fixtures/attributes/shapes off.

Note that other Titan consoles have separate Release and Off buttons, Off is used to access this function and Release is used to release a playback.

7.3 Editing cues

7.3.1 Editing a cue by merging

You can edit any part of a cue you have already saved simply by making the changes and saving the new information on top of the cue.

1> Press Clear to empty the programmer.

- 2> *Fire the cue you want to edit, so you can see what you are doing. Kill all other cues to avoid confusion.*
 - 3> *Select the fixtures you want to change, and make the changes.*
 - 4> *Press Record Cue.*
 - 5> *Press the Swap button for the cue you are editing.*
 - 6> *Press [Merge] (the cue being edited is highlighted on the screen).*
 - 7> *The console will merge the existing cue with your changes. Unchanged information is not affected.*
-

- If you want to overwrite the cue entirely, use the option [Replace] at step 6 – but remember that unless you are in “Record by Stage” mode, any fixtures you haven’t changed won’t be saved.
- To speed up editing, you can set the console to “Always Merge” the cue. This is option A in the User Settings (press Avo and select User Settings).
- You can also press the Swap button for the cue a second time to select the “Merge” option (quicker than selecting the softkey Merge option).

7.3.2 Updating stored values and palettes used in a cue

If during a show you need to quickly update a cue, or a palette used in a cue (for example you fire a green cue and the fixtures turn out to be not quite the right colour) the Update function lets you quickly update either the cue itself or the palettes used in the cue.

For instant update of a fired cue, change the fixture settings and press Update twice.

- 1> *With the cue fired, select the fixtures and change them to the settings you want to store (e.g. the right green colour).*
 - 2> *Press Record Cue, [Update].*
 - 3> *Press Enter to immediately store the new values to the cue. Alternatively, the softkeys show a list of palettes and playbacks which can be updated. Select or deselect these as required.*
 - 4> *If you have used the softkey options, press Enter to complete the update.*
-

- You can also select which palettes will be affected by pressing the palette’s button twice.
- If you manually set an attribute in the cue which was set by a palette, then press Update-Update, the palette will be removed from the cue. If you want to update the palette, use the softkey options or press the palette button.
- If you change an attribute using a different palette, the new palette will be stored instead.

7.3.3 Playback and Cue view

To see the current timings of the cue, touch the playbacks display for the fader, or press View then the swap button of the playback you want to view. The screen will show details of the delay, fade, overlap

and curve settings for the cue. You can touch each item to enable editing.

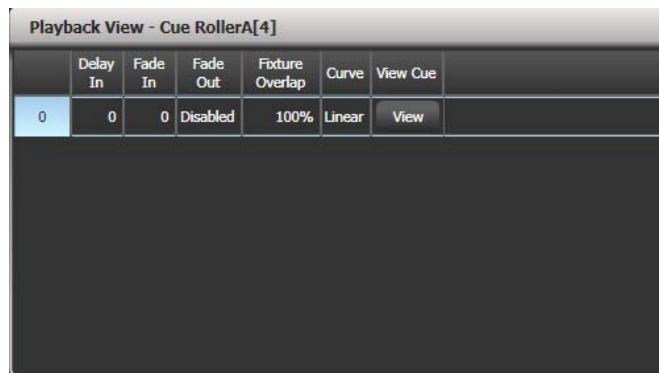

If you touch the View button at the right hand end of the row or the [View Cue] context button, the Cue View window opens, showing you details of the settings individual timings for all the fixtures in the cue.

The Cue View has four different views: Levels, Palettes, Times, Shapes. Views are selected using the context buttons to the left of the menu buttons.

- The **Levels** view shows the individual attribute values for each fixture.
- The **Palettes** view shows which palettes have been used to record the cue. Palettes are shown by their legends. Where an absolute value was saved rather than a palette, the value is shown instead. Again you can edit or remove the values.
- The **Times** view shows individual attribute timings for fixtures. If global timings are set, no times are shown in the cue view.
- The **Shapes** view shows which attributes of each fixture are running shapes.

	Number	Order	Dimmer	Shutter	Pan	Tilt	Colour Func	Colour	Cyan	Red	Magenta	Green	Yellow	Blue	CMY Macro	Gobo 1 Func	Gobo 1
ClrSp 1200	1		100.00	Closed	49.44	55.04	Fixed	Open	0.0	0.0	99.6	-	-	-	Index 0.0	-	-
ClrSp 1200	2		100.00	Closed	43.00	57.04	Fixed	Open	0.0	0.0	99.6	-	-	-	Index 0.0	-	-
ClrSp 1200	3		100.00	Closed	57.59	57.48	Fixed	Open	0.0	0.0	99.6	-	-	-	Index 0.0	-	-
ClrSp 1200	4		100.00	Closed	47.33	54.11	Fixed	Open	0.0	0.0	99.6	-	-	-	Index 0.0	-	-
ClrSp 1200	5		100.00						0.0	0.0	-	-	-	Index 0.0	-	-	-
ClrSp 1200	6		100.00						0.0	0.0	-	-	-	Index 0.0	-	-	-
ClrSp 1200	7		100.00						0.0	0.0	-	-	-	Index 0.0	-	-	-

You can edit or remove one or more individual control values in the cue.

Touch or drag over the required control values in the grid to select them – they will be highlighted in blue.

The softkeys then give you available settings for that control value, or you can directly edit values by typing numeric values and pressing enter.

You can delete the selected control(s) using the [Delete] softkey.

You can turn attributes On and Off using the Off button and the [On] softkey. Off temporarily removes a value from the cue, it can later be restored using [On].

You can remove a fixture completely from the cue by selecting the fixture then pressing the [Remove Fixtures] softkey.

Any changes take immediate effect.

- The context menu option View Tracking Values allows you to highlight in grey values which are tracked from previous cues.

7.3.4 Using parts of existing cues - the Include function

The Include function lets you load selected parts of a cue back into the programmer. (Normally, only manual changes to fixtures are put in the programmer). You can then use this to make a new cue. This is useful if you want to make a cue which is similar to one you already have, or to build a new cue from various parts of other cues. It's also useful when editing shapes in cues.

There are two modes, Quick Include and Advanced Include. Quick Include simply reloads the whole cue. Advanced Include allows you to specify which attributes of which fixtures you want to load into the programmer. So, for example, if you have a cue which contains position, colour and gobo information for 8 fixtures, you can use the include function to load only the colour information for 4 of the fixtures into the programmer. You could then Include position information from another cue into the programmer, and build up a new cue using information from several existing cues.

If you Include a chase or cue list, the screen shows you a list of the cues within it, and you select the one you want to Include using Wheel A or by touching the cue. You can also type in the cue number to Include.

-
- 1> *Press Include (above numeric keypad).*
 - 2> *Press [Quick Include] or [Advanced mode] if you want to change the mode.*
 - 3> *Press the Swop button of the cue you want to include into the programmer. If you are in Quick Include mode, this Includes the cue and finishes.*
 - 4> *If you are in Advanced mode, all fixtures in the cue will be selected. If you don't want them all, deselect the fixtures you don't want. The fixtures in the cue are highlighted on the HUD and on the fixture buttons.*
 - 5> *Use [Set Mask] or the Attribute Bank buttons to select which Attributes you want to include (All are included by default – Softkey C turns them all off and D turns them all on). Softkey E lets you include or exclude Shapes from the cue.*
 - 6> *Press Enter. The selected attributes of the selected fixtures will be loaded into the programmer.*
 - 7> *Repeat from 2 to include other attributes from the same fixtures, or repeat from 1 to include other fixtures.*
-

- In Quick Include mode, you can set a mask for the include by pressing one or more of the attribute bank buttons before you select the cue to include.

7.3.5 Removing attributes from cues using "Off"

The "Off" button allows you to remove an attribute which has been stored in a cue, as if you'd never recorded it.

For example, suppose you recorded a cue which had scans at a certain position, with the colour set to green. If you later decide that you don't want a colour recorded at all in the cue, so that the colour set by previous playbacks will remain, you set the colour values to Off in the programmer, which when saved will remove those values from the cue. You can also use the Off function to remove complete fixtures from a cue by selecting all the attributes.

Setting an attribute to Off is not the same as recording an attribute at zero, since this would change the attribute when the cue was fired. It is the same as excluding that attribute using the mask when recording, so the attribute will remain unchanged when the cue is fired.

-
- 1> *Press Off followed by the playback to be changed. (On consoles which do not have a Release button, you need to press Off, then [Off Console Values], then the playback)*
 - 2> *Select fixtures to be set to Off.*
 - 3> *Set the attribute mask to determine which attributes will be set to Off.*
 - 4> *Press the [Off] softkey.*
-

You can also use Include to set values to Off.

-
- 1> *Use the Quick Include function (described in previous section) to load the cue you want to change into the programmer.*
 - 2> *Press the Off button to display the Off menu.*
 - 3> *All fixtures in the cue will be selected. If you don't want to change them all, deselect the fixtures you don't want.*
 - 4> *Use the softkeys to select which Attributes you want to remove.*
 - 5> *Press Record Cue, then set the record mode to [Replace], and press the Swap button of the cue to update it.*
-

- You can merge "Off" attributes into a cue without including it first.
- You can also remove attributes from palettes using the Off function.
- Another way to remove attributes is from the Cue View window. See section 7.3.3 on the previous page.
- Attributes set to Off can be restored to their previous value using the On function. Set the attribute to On and merge it into the cue.

7.4 Copying, moving, linking and deleting

7.4.1 Copying or moving a cue

Using the Copy/Move/Link button you can make a copy of an existing cue, move it to a new playback, or create a new playback which is linked to the existing playback. You can copy, move or link multiple playbacks (which may be cues, chases or cue lists) in one operation.

Move is useful for tidying up the console. Linked cues are handy if you want a cue to appear on more than one page for ease of

operation; also the linked cue can have different timings and playback options from the cue it's linked to.

-
- 1> *Press the Copy/Move/Link button.*
 - 2> *Select [Copy], [Move] or [Link]. Pressing the Copy/Move/Link button again will also toggle these options.*
 - 3> *Press the Select button of the cue you want to copy/move/link. You can select a range of playbacks by holding the first button while pressing the last in the range.*
 - 4> *Press the empty Select button where you want it to go.*
-

- The Menu Latch button latches the Copy/Move/Link menu, so you can keep copying, moving or linking things without having to keep pressing the Copy/Move/Link button. Press Exit to unlatch.
- [Retain Layout] or [Bunch Up] is used when copying a group of cues with empty playbacks in the group – you can either keep the empty playbacks, or bunch up the used playbacks together.
- When in Copy mode, option [Copy Legends] can be changed to [Don't copy legends] so that the copied cues are given default legends.
- When in Move mode, [Swap Items if Required] will attempt to reposition any existing playbacks which are in the way of the move. This is useful when rearranging playbacks on a page which is nearly full.

7.4.2 Deleting a cue

To delete a cue:

-
- 1> *Press the Delete button.*
 - 2> *Press the Select button of the cue you want to delete.*
 - 3> *Press the Select button again (or press Enter) to confirm the delete.*
-

- Press Menu Latch to keep the delete mode active. You can keep deleting using steps 2 and 3 without having to keep pressing the Delete button. Press Exit to leave latched delete mode.

7.5 Cue timing

The console allows a wide variety of timing functions to be set for each cue.

7.5.1 Setting fade times and Overlap for a cue

When programming a cue, you can set a delay, fade in and fade out time for each attribute of each fixture, or globally for the cue. Shapes in the cue will also be affected, depending on the fade mode.

You can delay the fade times between fixtures in a cue so that the cue is applied sequentially to each fixture. This is called Fixture Overlap and can create some amazing "peel off" or "roll" type effects with no programming at all.

In the diagram below, the top picture shows how the LTP channels change when used with delay, fade and fade out times. The second picture shows how the HTP channels change. The third and fourth

pictures show what happens to the LTP channels when fixture overlap and attribute fade are used.

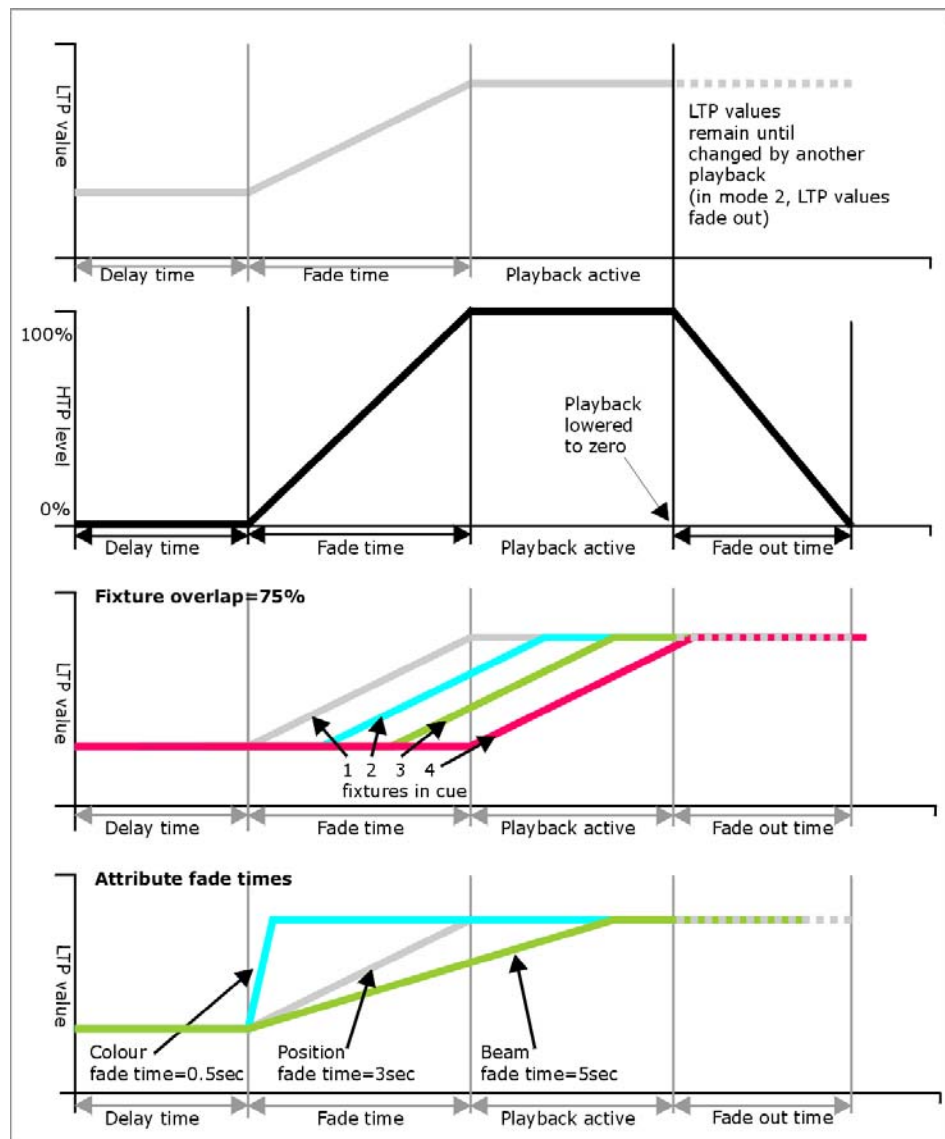

All times which you have set while programming the fixtures/dimmers will be recorded when you save the cue.

You can also edit times of a cue you have already saved like this:

- 1> Press [Edit Times] at the top level menu.
- 2> Press the Swop button of the cue.
- 3> Press [Fade Mode x] to set the cue mode. This sets how the times are used, see below.
- 4> Press [Delay time] to set the delay before the cue starts, [Fade time] to set the fade-in time of the cue, and [Fade out time] to set the fade-out time of the cue.
- 5> Type the new time (in seconds) using the numeric keypad and press Enter to save it.
- 6> Press [Fixture Overlap] to change the overlap, then enter 0-100 on the keypad. 100% means all fixtures fade together. 0% means that the first fixture will finish its fade before the next one starts. 50% means that the 2nd fixture will start fading when the first one is half way through its fade. The order of the

fixtures is set by the order you selected them (but you can change this, see section 7.5.2).

7> Press Exit to get out of Edit Times mode.

- You can also set independent times for the IPCGBES attribute groups, and for each individual attribute, see next section for details of this.
- You can quickly set times from the keypad using the Time button, e.g. TIME 5 AND 2 sets 5 sec fade in and 2 sec fade out. (The Time button is the button previously labelled Set on Titan Mobile and Sapphire Touch, and Next Time on Tiger Touch and Pearl Expert).

The times you enter are affected by the cue mode which is set using the [Fade Mode] option:

- Mode 0 – Channels will fade in as set by the fade time. The Fade Out time is ignored. If times are set to zero, the HTP channels fade in with the 0-100% position of the playback fader and the LTP channels will snap.
- Mode 1 - Channels fade in as set by the fade time. HTP channels fade out as set by the fade out times (LTP channels remain as set in the cue). If times are set to zero, the HTP levels will fade in and out with the fader and the LTP channels will snap when the cue is fired.
- Mode 2 – Channels will fade in as set by the fade time. The Fade Out time is ignored. However, the fade will stop when the fader position is reached, so if the fader is set to 50%, the attributes will stop half way to their programmed position. You can reverse the fade back to the original position by moving the fader back. If times are set to zero, both HTP and LTP channels are controlled by the fader position. In this mode LTP channels revert to their previous settings when the cue is deactivated. Mode 2 is useful when used with a pan/tilt cue for manually tracking a spot across a stage or down a catwalk using the fader position.
- Mode 3 - Crossfade cue. All channels, including intensity channels, will fade to the settings in the new cue. All other cues fade out and all other active playbacks become inactive; if you need to re-fire a playback, take the fader to zero and put it up again.
- If the cue includes shapes, then the shape will change with fade times. The changes will be timed for a Mode 1 cue and controlled by the fader position for a Mode 2 cue. This allows you to create a shape which gets bigger or faster as you push up the fader.

7.5.2 Changing fixture order

You can change the order of the fixtures stored in a cue. Normally this is set to the order in which you selected the fixtures when the cue was created, but you might want to change this (for example to pair up fixtures so they move together when using Overlap).

- 1> Press [Edit Times] at the top level menu.
- 2> Press the Swop button of the cue to be changed.
- 3> Press [Fixture Order].
- 4> Set the sequence number to start from using option A.
- 5> If you want the sequence number to increase automatically, set [Autoincrement] to On. If you want some fixtures to have the same sequence number, set it to Off.
- 6> Touch the Select buttons of the fixture(s) you want to place in that position in the sequence. The sequence number is shown in the top right hand corner of the fixture select touch buttons.



- 7> Press Exit to finish.

- You can set several fixtures to have the same sequence number. This means, for example, when used with Overlap they will all do the same thing at the same time.
- You can remove a fixture from the sequence by turning off [Autoincrement] and pressing the fixture button twice. The fixture sequence will show X. Touch the button again to put it back in the sequence.

7.5.3 Setting attribute fade times for a cue

You can set individual fade times for each attribute group (such as Position). If you set a time, it overrides the normal times.

To set an attribute group fade time:

- 1> Press [Edit Times] at the top level menu.
- 2> Press the Swop button of the cue to be changed.
- 3> Press the Attribute Bank button (right hand side) for the attribute you want to change.
- 4> Press [Delay] to set delay time or [Set fade] to set fade time.
- 5> Type the new time using the numeric keypad and press Enter to save it, or press [Use Global] to delete the attribute times and go back to the normal times.
- 6> Press Enter to save the changes.

You can take this even further and set individual fade times for each fixture. When you select the cue to be changed, you will see that all the fixtures in the cue are selected. To set attribute times for only certain fixtures, change the fixture selection using the Swop buttons.

The Cue View window will display when editing cue timings to help you see what you are editing. You can touch fixtures or attributes in the grid to select which items are going to be edited.

Press the ALL button to select all fixtures in the cue.

When you are in the Set Attribute Times menu you can only select fixtures which are in the cue you are editing.

7.5.4 Editing times in the programmer

You can check and edit the times which are set in the programmer before saving a cue. You can also set times into the programmer and merge them into cues as a quick way of updating times, just like you would with attribute values.

Press the Time button to access this menu.

- On Titan Mobile and Sapphire Touch, the Time button is the key above Clear (previously labelled SET). On Pearl Expert and Tiger Touch it is the key previously labelled NEXT TIME.

The menu allows you to set cue times, or times for all attributes of a fixture, attribute groups or individual attributes.

Using the Time button there are various quick shortcuts to setting times.

- TIME 5 = 5 sec fade in.
- CUE 3 TIME 5 = 5 sec fade in on connected playback's cue 3.
- TIME FIXTURE 5 – 5 sec fade in for all attributes of selected fixtures.
- TIME FIXTURE G 5 – 5 sec fade in for gobo attribute group of selected fixtures.
- TIME FIXTURE @B 5 – 5 sec fade in for attribute connected to wheel B on selected fixtures.
- 5 @ 3 – 5 sec fade in, 3 sec delay.
- 5 AND 2 – 5 sec fade in, 2sec fade out.
- 1 THRO 10 - times spread across fixtures according to selection order.

Individual attribute times can also be set from the wheels, using the [Wheels] softkey option on the root menu.

7.6 Advanced options

To set options for a cue, press [Playback Options] on the root menu, then press the swop button of the playback to be edited.

These options are also available for Chases and Cue Lists.

7.6.1 Release mask

[Release Mask] lets you specify which attributes will be released to the state they were in from a previously fired playback when this playback is killed (you lower the fader to zero). You can also use the Attribute Bank buttons to set the mask. The default setting is to not release any attributes.



Release mask is useful when creating a temporary strobe effect on a playback. Press [Release Mask] then the Shutter attribute button (Intensity on Titan Mobile). Now when you turn off the playback the shutter will

release to its previous state and the strobe will stop.
When using with chases you need to press [Mask]
before pressing the Shutter button.

You can use Key Profiles to allocate one of the handle buttons to release the playback.

7.6.2 Shape size/speed on fader

If the cue contains shapes, options B and C set how the shape behaves when the playback fades in. You can set the size and/or speed to be either fixed or to change with the fader.

You can also allocate a Speed Master to the cue which will allow you to modify the shape during playback, see section 7.2.4 on page 129.

7.6.3 Curve

[Curve] defines how the attribute values will change when the playback is faded in. The various curves are illustrated in section 12.5 on page 198.

7.6.4 Locking a playback onto a handle

This option allows you to lock the playback on a handle so that it always appears on that handle no matter what page is selected. This is useful if you have some general playbacks you want on every page, without having to copy the playback onto each page.

If you select "Transparent Lock" then the playback will appear on the current page only if no other playback is programmed in that position.

7.6.5 Playback priority

This option allows you to configure how playbacks will behave if you turn on two playbacks controlling the same fixture. The priority can be set to Low, Normal, High or Very High. If a fixture is being controlled by a playback and you turn on a playback of the same or higher priority, then the new playback will take over. However, if the new playback is set to lower priority than the first playback, the fixture will not change.

This is useful if, for example, you've programmed looks using all your fixtures, then you decide you want a couple of them to spotlight a singer. If you set the Spotlight playback to be high priority, then while it is active no other playback will affect the spotlight fixtures.



Priority is useful when using Swop buttons for strobe-type effects where you want to black out everything else. If you have a position shape running on other fixtures, you don't want that to stop during the Swop, or it will look messy when you release the Swop button. So set the shape playback to have a higher priority than the strobe playback, and it will keep going during the strobe and continue smoothly when you release the Swop button.

- Attributes set by manually applying a palette to a fixture will override all playback priorities except Very High.

7.6.6 Blind mode

Individual playbacks can be set to Blind mode using this option. The playback will then output only to Visualiser, not to the stage. This can be very useful if you need to program cues during a live show.

7.6.7 Key Profile

Each playback can have an individual Key Profile allocated to it. This allows you to customise the panel button functions differently for each playback. A list of available Key Profiles is shown, or you can add a new one. The softkeys show the function allocated to the blue and grey buttons for each of the available Key Profiles.

If the playback Key Profile is set to "None", the default global profile is used.

8. Chases

As well as being used to store static cues, the playback faders can also be used to store chases (sequences of cues). You can also store chases on touch buttons in the Playbacks window.

Chases can run once or repeat continuously. You can set individual fade time for each cue in the chase and unlink cues so that the console waits for you to press Go before the chase continues.

8.1 Creating a chase

8.1.1 Programming a chase

To program a chase, you have to set up the look for each cue in the chase, then save it.

You can either set all the fixtures and dimmers manually for each cue in the chase, you can use Quick Build to create a state from palettes and cues, or you can use Include to load in cues.

-
- 1> *Press the Record Chase button.*
 - 2> *Press the Swop button of the playback where you want to store the chase (you can also store chases on touch buttons in the Playbacks window).*
 - 3> *Set up the look for the first cue, either manually or by using "Include" on existing cues.*
 - 4> *You can change the number given to the step using [Step Number].*
 - 5> *Press the Swop button of the playback to store the programmer contents as a step of the chase. You can also press [Append Step] on the menu.*
 - 6> *Press Clear (unless you want to re-use the contents of the programmer), then repeat from step 3.*
 - 7> *Press Exit to finish when you have stored all the cues you want.*
-

- [Record Mode] lets you select Record By Fixture (all attributes of any modified or selected fixture are saved), Record By Channel (only modified attributes are saved), Record Stage (all fixtures with a non-zero dimmer setting are saved), or Quick Build (see next section).
- The cue number currently being saved, and the total number of cues, is shown on the top line of the display.
- Press Clear when you have finished recording the chase, otherwise when you try to play it back the programmer will override the chase and you won't see the chase properly.
- You can record shapes in a chase. If the same shape is saved in subsequent cues it will continue from step to step and if not it will stop at the end of the cue. (The shape is the same if you didn't press Clear after the previous step, and didn't change the speed, size or phase of the shape from the previous step; or if you Included the shape from the previous step and have not modified it)

- You can set a legend for the chase by pressing Set Legend, then pressing the Swop button for the chase and entering the legend, as with cues.
- There is no limit to the number of steps in a chase.

8.1.2 Creating a chase with Quick Build

Quick Build mode, as the name suggests, allows you to build a chase very quickly from existing palettes and playbacks.

Start recording a chase as described in the previous section, set [Record Mode] to Quick Build.

Select any palette or playback to insert that item as a step in the chase. If you select multiple palettes by selecting a range of buttons, each palette will be added as a separate step.

To insert specific fixtures from a palette or playback, select the fixtures first and then select the palette or playback.

8.2 Playback

8.2.1 Playing back a chase

To fire a chase, raise the fader of the playback. (You can also use the Flash/Swop buttons). The chase will start to run. The bottom line of the screen relating to the playback fader shows the current cue number and speed of the chase.

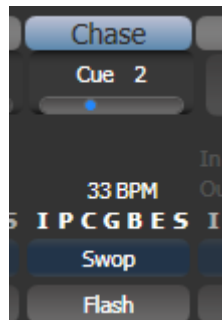

- The HTP (intensity) channels in the chase will be controlled by the fader; if fade times are programmed, the fade will stop at the fader level. The other channels (LTP) will be set as soon as the fader moves above zero according to the fade times programmed in the chase. You can set the point at which the LTP channels activate from the User settings menu.
- While the chase is running, the area of the screen above the wheels shows details of the chase steps.

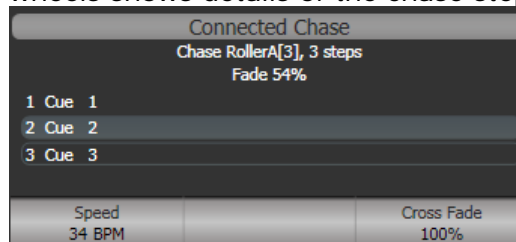

- You can temporarily pause the chase by pressing the Stop button near the wheels. Press Go to resume playback.

There are many options you can set to determine the way the chase runs and these are described in the rest of this chapter.

8.2.2 Connecting a chase for control

When you fire a chase, the wheels and Stop/Go buttons are automatically allocated to control the speed and crossfade of the chase – this is called Connecting the chase. If you have more than one chase running, you can choose which chase is connected to the controls using the Connect button.

- Connect a different chase to the controls by pressing the Connect button then the Swop button of the chase you want to control.
- Disconnect a chase from the controls by double pressing the Connect button.
- You can turn off the “chase autoconnect” option in the User Settings menu if you don’t want to connect to a chase when you fire it. You will have to use the Connect button to control the chase if you do this.
- Normally if you change the speed or crossfade of a chase, the new setting is saved. However you can set this change to be temporary, so that when the show is reloaded the speed and fade will go back to the previously saved settings. Go to User Settings (Avo button + [User Settings]) and set option C to [Connected View Sets Temporary Chase Speed]. You can still save a temporary speed by pressing [Save Temporary Speed] in the Set Times menu.

8.2.3 Setting speed and crossfade for a chase

The left wheel is assigned to control the speed of the chase it is connected to. The speed is shown in Beats Per Minute (BPM) on the display. You can also enter a speed from the keypad as described below. The last speed you set on the wheel is always remembered, you do not have to tell the Tiger Touch to save it.

Crossfade is the “slope” between cues; with a crossfade of 0, the fixtures snap instantly to the next cue, but with a crossfade of 100, the fixtures spend the whole cue time fading to the next cue. With a crossfade of 50, the fixtures delay for half the cue time and fade for the other half of the time.

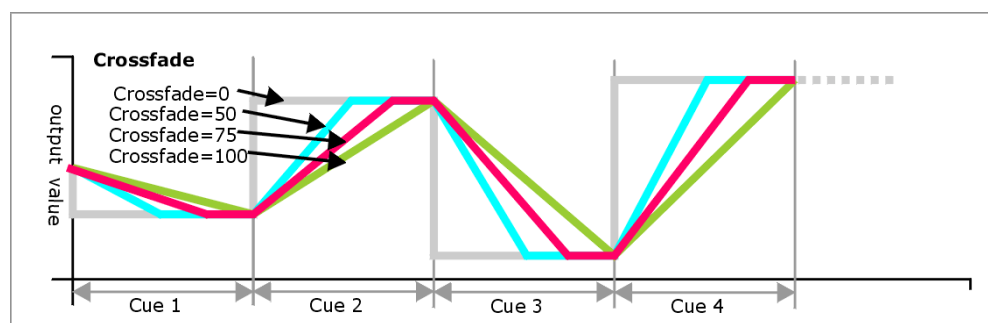

You set the crossfade and speed as follows:

- 1 > Press [Edit Times] from the top level menu then the Swop button of the chase.

- 2> *To set the crossfade, press [Xfade] and type the fade from 0 – 100. 0=no fade (the chase will “snap”), 100=max fade (the chase will move continuously from step to step).*
 - 3> *To set the speed, press [Speed], type the new speed, then press Enter. The speed can be set in Beats Per Minute (BPM) or seconds depending on the User Settings.*
-

There are other options you can set for the chase from this menu including Fixture Overlap, which are described in the Timings section 8.5.1 on page 148.

You can set individual times for each cue in a chase and unlink cues from each other so they wait for you to press the Go button. This is done using the Playback View, or the Unfold function which is described in section 8.3.2 on page 147.

You can select whether the chase speed is displayed in seconds or in Beats Per Minute (BPM). Press Avo and [User Settings], then press [Tempo Units] to set the option to [Tempo Units Seconds] or [Tempo Units Beats Per Minute (BPM)].

You can also allocate a Speed Master to the chase which will allow you to modify the chase speed during playback, see section 7.2.4 on page 129.

8.2.4 Manually controlling the steps of a chase

You can pause a chase, if the chase is connected to the wheels, by pressing the Stop button next to the wheels. Press the red Go button to resume playback of the chase.

While the chase is stopped you can use the ← and → buttons next to the Connect button to move to the next or previous step.

You can also configure the blue and grey buttons of the playback handle to be Stop and Go. This uses the Key Profiles function.

- 1> *Hold Avo and press [Edit Current Key Profile].*
 - 2> *If you are using the default Key Profile which is not editable, you will be prompted to add a new profile.*
 - 3> *Press [Chases] then choose either the Blue key or the Grey key.*
 - 4> *Select Go or Stop from the list of functions. Then press Exit and set the function for the other key if required.*
 - 5> *Press Exit to continue using the console.*
-

8.2.5 Changing chase direction

The ← and → buttons next to the Connect button set the direction of the connected chase. The ↔ double-ended arrow button sets bounce mode where the chase will run to the end then reverse. The Review key sets the chase to Random.

8.2.6 Jumping to a step

You can jump directly to a step in a chase by pressing the Connect button, then typing in the desired step number, then pressing Enter or softkey A. Alternatively at the top level menu you can type the step number then press Connect.

8.3 Editing a chase

8.3.1 Opening a chase for editing

You can open a chase for editing by pressing Chase then the Swop button of the chase. This does not affect any existing cues in the chase. You can then save new cues at the end by pressing the Swop button just like normal recording.

To see a list of the cues in the chase, use Playback view (touch the playback display above the fader or press View then the Swop button of the playback). To edit any of the time settings in each cue, select the setting to be modified by touching or dragging in the grid, then use the softkey options to change the setting.

Playback View - Chase 'PRESS GO'							
	Legend	Delay In	Fade In	Fade Out	Fixture Overlap	Link	View Cue
1	Cue 1	Global	Global	= As In	Global	After Previous	View
2	Cue 2	Global	Global	= As In	Global	After Previous	View
3	Cue 3	Global	Global	= As In	Global	After Previous	View
5	Cue 5	Global	Global	= As In	Global	After Previous	View
6	Cue 6	Global	Global	= As In	Global	After Previous	View
7	Cue 7	Global	Global	= As In	Global	After Previous	View
8	Cue 8	Global	Global	= As In	Global	After Previous	View

8.3.2 Editing a chase using Unfold

Unfold provides another way to edit chases. The Unfold button places each cue in a chase on one of the playback faders, allowing you to fire and edit each cue individually as if it was a stand-alone cue. Unfold also allows you to set individual timing for cues in the chase.

-
- 1> Press the Unfold button, then the Swop button of the chase to be edited.
 - 2> The first 10 cues of the chase are loaded into the playback faders.
 - 3> Raise a playback fader to output the contents of that cue (fade times will operate as programmed).
 - 4> Various Unfold options are available, the details are below.
 - 5> Press Unfold again to get out of unfold mode.
-

- To edit the contents of a cue: Press Clear to empty the programmer, raise the fader to output the cue, make the changes, press [Record Step], then the Swop button for the cue number.
- To Insert a new cue at the end of the chase, set up the look for the new cue, press [Insert Step], then press the swop button of the first free playback.

- To merge the programmer into the live step, double tap [Record Step].
- To Insert a cue between two other cues, set up the look for the new cue, press [Insert Step], then type the cue number for the new cue (such as 1.5 to go between 1 and 2). If this cue number already exists it will be merged with the look you have created. Otherwise a new cue is inserted.
- To change individual times for the cue, press [Edit Times], then the Swop button for the cue (or type the cue number), then set the times. This is described in detail in the Timing section on the following page.
- If the chase has more steps than there are playback faders, you can go between pages using the [Previous Page] and [Next Page] buttons.

8.4 Copying, moving, linking and deleting

8.4.1 Copying or moving a chase

Chases can be copied or moved to a new playback, or you can create a linked copy of a playback. Move is useful for tidying up the console. Linked chases are handy if you want a chase to appear on more than one page for ease of operation; the linked chase can have different timings and playback options.

This operation is exactly the same as for Cues and is described in detail in section 7.4.1 on page 134.

8.4.2 Deleting a chase

You can delete an entire chase by pressing the Delete button followed by the Swop button of the chase to delete. Press once more to confirm.

8.4.3 Deleting a step from a chase

To delete a single step from a chase:

-
- 1> *Press the Delete button.*
 - 2> *Press the Swop button of the chase.*
 - 3> *The steps in the chase are listed on the screen. Use the left hand wheel to select the step you want to delete, or type in the number of the step to be deleted.*
 - 4> *Press [Delete Cue x] to delete the step.*
 - 5> *Press [Confirm] to confirm the delete.*
-

- Alternatively you can use the Unfold function to delete a step from a chase.

8.5 Chase timing

8.5.1 Global timings for chases

When a chase is first programmed, each cue in the chase has identical timing. This is called the global timing for the chase. If you want you can then set each cue to have its own timings using the Playback View window or Unfold. This is described in the next section.

- 1> Press [Edit Times] from the top level menu then the Swop button of the chase.
- 2> Set the Crossfade, Speed, Fixture Overlap and Attribute Overlap settings as described below.
- 3> Press Exit to finish.

- To set speed, press [Speed] then type the new speed, then press Enter. The speed can be set in Beats Per Minute (BPM) or seconds depending on the user settings.
- To set crossfade, press [Xfade] then type the fade from 0 – 100 and press Enter. 0=no fade (the chase will “snap”), 100=max fade (the chase will move continuously from cue to cue).
- When in Run mode, you can set the chase speed of the connected chase by tapping the [Tap Tempo] button in the main menu at the speed you want the chase to run. (The option only appears when a chase is connected). You can also assign the blue or grey handle button to be a “tap tempo” button using the Key Profiles option (see section 12.2.1 on page 192).

The Overlap functions allow you to offset and overlap the timing of changes in the chase. This can create really amazing visual effects with hardly any programming. The best way to learn about overlap is to program a chase with two cues involving several fixtures, then experiment with the overlap settings to see the various “roll” and “peel off” effects which result.

The following diagram shows you the effects of cue overlap, fixture overlap and attribute overlap in chases.

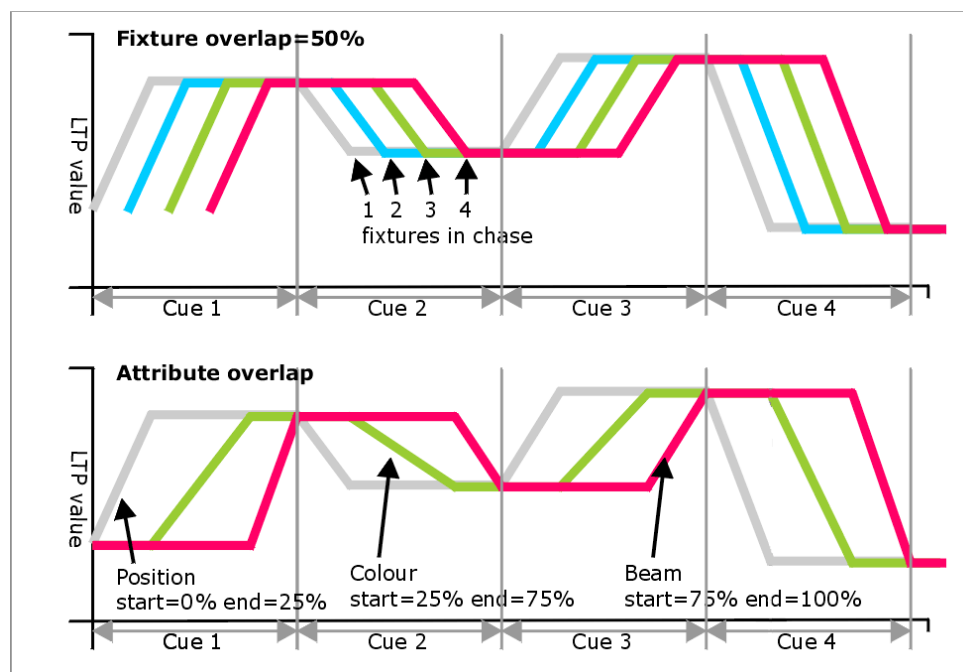

- Press [Fixture Overlap] then enter 0-100 on the keypad to change how fixtures overlap in the cue. 100% (the normal setting) means all fixtures fade together. 0% means that the first fixture will finish its fade before the next one starts giving a “rolling” change across a range of fixtures. 50% means that the 2nd fixture will start fading when the first one is half way

through its fade. The order of the fixtures is set by the order you selected them when the cue was saved; you can change the order using Unfold.



From version 3 of Titan software, [Cue Overlap] is no longer available in chases. Instead use a Cue List set to "Link With Previous" and set the Offset as desired.

8.5.2 Individual cue times in chases

You can configure each cue in a chase to have its own timing information. You can use the Playback View window, or the Unfold function to set individual times for cues in chases.



It is easier to use a Cue List rather than a chase if you need a lot of different timings or link/unlinks. Cue lists are described in the next chapter.

Using the Playback View window:

- 1> *Touch the playback display relating to the fader, or press View then the swop button of the playback. The Playback View window will open.*

Playback View - Chase 'PRESS GO'							
	Legend	Delay In	Fade In	Fade Out	Fixture Overlap	Link	View Cue
1	Cue 1	Global	Global	= As In	Global	After Previous	View
2	Cue 2	Global	Global	= As In	Global	After Previous	View
3	Cue 3	Global	Global	= As In	Global	After Previous	View
5	Cue 5	Global	Global	= As In	Global	After Previous	View
6	Cue 6	Global	Global	= As In	Global	After Previous	View
7	Cue 7	Global	Global	= As In	Global	After Previous	View
8	Cue 8	Global	Global	= As In	Global	After Previous	View

- 2> *In the grid, touch the times you want to edit.*
 - 3> *Use the softkey options to change the times or settings.*
 - 4> *Repeat from 2 to change other times or settings.*
- You can change a range of cues all at once by dragging across the grid to select multiple cells, or you can use wheel B to select multiple cells for editing.

Using Unfold:

- 1> *Press the Unfold button, then the Swop button of the chase to be edited.*
- 2> *Press [Edit Times] then the Swop button of the unfolded cue you want to edit.*
- 3> *Set up the timing options as required. The options are described below.*
- 4> *Press Unfold to get out of unfold mode.*

Initially all the timing options are set to Global. You can cancel any individual timings and set the time back to global timings by pressing the softkey for the option then pressing [Use Global].

The timing options for the cue are:

- Delay
- Fade (in)
- Fade Out
- Fixture Overlap
- Link with previous step
- Attribute times (see next section)

Linking can be set to [Link After Previous] (the chase will run automatically) or [Link Wait For Go] which will stop the chase until you press Go.

8.5.3 Setting attribute fade times for a cue in a chase

For each cue in a chase, you can set individual fade times for each attribute group (such as position). If you set a time, it overrides the normal times. You can use the Cue View window, or the Unfold function to set attribute times.

To set an attribute group fade time:

-
- 1> Press View or the Unfold button, then the Swop button of the chase to be edited.
 - 2> Press [Edit Times] then touch the cue you want to edit in the Playback View, or if using Unfold, press the Swop button of the unfolded cue you want to edit.
 - 3> Press the Attribute Options button (right hand side) for the attribute you want to change.
 - 4> Press [Delay] to set delay time or [Set fade] to set fade time.
 - 5> Type the new time using the numeric keypad and press Enter to save it, or press [Use Global] to delete the attribute times and go back to the normal times.
 - 6> Press Enter to save the changes.
-

8.6 Advanced options

To set options for a chase, press [Playback Options] on the root menu, then press the swop button of the playback to be edited.

The same options are available as for Cues (see section on page 139), with some additional options for Chases:

8.6.1 Loop/Stop on Final Cue

Option B lets you specify whether the chase will loop back to the beginning or stop on the final cue.

8.6.2 Forwards/backwards/bounce/random

Option C sets the direction of the chase.

8.6.3 Cue linking

Option D sets how the cues in the chase are linked. The settings are:

- [Always Link Steps]: The chase will run on its own using the times
- [Never Link Steps]: The chase will pause after every delay/fade time for the user to press Go.
- [Link according to individual steps]: Each step in the chase will obey its individual link settings which are set using the Playback View window or the Unfold function.



When a chase is unlinked, raising the fader does not fire the first cue, which can be a problem. To get round this, if the chase is not looped, simply link the first cue to the previous one. If the chase is looped, add a dummy step at the end with 0 sec fade, 0 sec delay and link the first step to this one.

8.6.4 Renumber cues

Option [Renumber cues] will renumber all the cues in the chase starting from 1.

9. Cue Lists

Cue Lists allow you to record a sequence of cues, each of which can have its own timings and can be triggered by the Go button or run automatically to the next cue. This allows you to build a complete show in a single list and is ideal for theatrical shows where the show must be exactly the same each time. Cue lists can also be useful in busked shows, especially on consoles with a small number of playback faders, to offer a number of different looks on one fader.

Cue lists differ from chases in the way the console handles changes between cues. Cue lists track fixture state from previous cues and will only change the fixture state if you have modified that fixture in the cue; if there are no changes stored for the fixture, it will remain in the same state. Chases on the other hand would crossfade between cues, fading out all fixtures which have no stored information in the new cue.

You can change the tracking behaviour of cue lists using the tracking option for each cue: Block, This Cue Only and Solo (see section 9.6.9 on page 168).

To view the contents of a cue list, touch the playback screen relating to the fader or press View then the swop button of the playback.

Playback View - Cue List Playbacks[7]												
	Legend	Delay In	Fade In	Delay Out	Fade Out	Fixture Overlap	Link	Link Offset	Preload	Curve	Autoload	Tim
1	Tabwarm	0	2	= As In	= As In	100%	Wait For Go	Disabled	<input type="checkbox"/>	Linear	Load Cue RollerB[3];	23:5
2	Cue 1	0	2	= As In	= As In	100%	Wait For Go	Disabled	<input type="checkbox"/>	Linear		23:5
3	End of scene	0	2	= As In	= As In	100%	Wait For Go	Disabled	<input type="checkbox"/>	Linear		23:5
4	Cue 2	0	2	= As In	= As In	100%	Wait For Go	Disabled	<input type="checkbox"/>	Linear		23:5
5	Cue 5	0	2	= As In	= As In	100%	Wait For Go	Disabled	<input type="checkbox"/>	Linear		23:5
6	Cue 6	0	2	= As In	= As In	100%	Wait For Go	Disabled	<input type="checkbox"/>	Linear		23:5

9.1 Creating a cue list

9.1.1 Programming a cue list

Programming a cue list is similar to recording a chase.

You need to set up the look on the stage for each cue and then add it to the cue list. If you want to set fade times, you can either set them while saving the cues or later.

- 1> Press the Record Chase/List button twice (or press Record Chase/List then [Create Cue List]).
- 2> Press the blue Select button of the playback where you want to store the Cue List (you can also store cue lists in the Playbacks window).
- 3> Select the Record Mode of the console: by Fixture, Channel, Stage or Quick Build; using [Record Mode Channel] is best as

you are sure to only record the attributes you have explicitly set, but you do need to make sure you have changed all the things you want to be recorded so they are in the programmer.

- 4> *Set the default Fade and Delay times, and automatic cue linking, using [Set Times]. These settings will be allocated to every new cue.*
- 5> *Set up the look for the first cue, either manually or by using "Include" on existing cues. You can use the Shape Generator and the Pixel Mapper.*
- 6> *If you require a legend for the cue, set it now using [Legend]. You can also change this later using Unfold or Set Legend (see next section).*
- 7> *Press the Select button of the handle or [Append Cue] to store the programmer contents as Cue 1 of the cue list.*
- 8> *Repeat from step 5 for the next cue. Do not press Clear in between cues, unless you want levels to track through from previous cues, as any faders moving to zero will not be stored. If you do press clear, you must make sure that all channels you want to record are selected or in the programmer (inverted display).*
- 9> *Press Exit to finish when you have stored all the cues you want.*

- [Record Mode] lets you select Record By Fixture (all attributes of any modified or selected fixture are saved), Record By Channel (only modified attributes are saved), Record Stage (all fixtures with a non-zero dimmer channel are saved) or Quick Build (allows you to build a cue from other playbacks or palettes; select the playbacks/palettes you wish to use and press [OK]).
- Record By Channel is useful if you want to layer this cue list with other playbacks to create an effect.
- You can reopen the cue list to add more cues by repeating the procedure above; this does not affect any cues already stored in the cue list.
- To add more cues to the end of the existing cues press [Append cue].
- To edit an existing cue, press [Cue Number=] and type the cue number to edit. Make the changes then press [Update Cue x].
- To insert new cues, see section 9.3.5.
- The Advanced Options menu allows you to renumber all the cues, and to change the number of an existing cue.
- There is no limit to the number of cues in a cue list.
- Cue lists offer a Move In Dark function which will move fixtures to the correct position for their next cue while they are set to zero intensity. See section 9.6.10 on page 168.
- You can change the tracking mode of each cue. See section 9.6.9 on page 168.

9.1.2 Changing legends for cues in a cue list

You can set a legend for each cue, which is shown on the screen when running the cue list and can be helpful for keeping track of where you are.

-
- 1> Press [Set Legend] in the top level menu. If you are setting legends for several cues, press Menu Latch to latch the Set Legend menu.
 - 2> Press the Select button of the Cue List.
 - 3> The cues in the cue list are shown on the screen. Touch the list or use Wheel A to select the cue which is to have a legend set.
 - 5> Press [Cue Legend] and type the legend on the keyboard, then press Enter.
 - 6> If you latched the menu, you can continue to set legends for other cues, or press Exit to finish.
-

9.1.3 Autoloading a playback within a cue list

You can program a cue within a cue list to automatically load one or more playbacks when the cue fires. The playback can be a single cue, a chase or another cue list. This can be a useful way to trigger chases or effects from the cue list.

You can either automatically save active playbacks as Autoloads, or you can manually allocate Autoloads to cues.

To automatically record active playbacks as Autoloads:

-
- 1> After selecting Cue List Record, turn on [Autoload Live Playbacks] in the [Advanced Options] menu of the cuelist record screen.
 - 2> Turn on the playbacks you wish to load for this cue.
 - 3> Save the cue. Active playbacks will be saved as Autoloads.
-

To manually edit autoloads:

-
- 1> Press [Playback Options] in the top level menu.
 - 2> Press the blue Select button of the Cue List.
 - 3> Press [Autoload].
 - 4> The cues in the cue list are shown on the screen. Use Wheel A to select the cue which is to have the Autoload set.
 - 5> Press the Select button of the playback which is to be loaded. The playback legend appears on the softkeys.
 - 6> You can continue to add Autoloads to other cues, or press Exit to finish.
-

Playback View - Cue List Playbacks[7]												
	Legend	Delay In	Fade In	Delay Out	Fade Out	Fixture Overlap	Link	Link Offset	Preload	Curve	Autoload	Time
1	Tabwarm	0	2	= As In	= As In	100%	Wait For Go	Disabled	<input type="checkbox"/>	Linear	Load Cue RollerB[3];	23:5
2	Cue 1	0	2	= As In	= As In	100%	Wait For Go	Disabled	<input type="checkbox"/>	Linear		23:5
3	End of scene	0	2	= As In	= As In	100%	Wait For Go	Disabled	<input type="checkbox"/>	Linear		23:5
4	Cue 2	0	2	= As In	= As In	100%	Wait For Go	Disabled	<input type="checkbox"/>	Linear		23:5
5	Cue 5	0	2	= As In	= As In	100%	Wait For Go	Disabled	<input type="checkbox"/>	Linear		23:5
6	Cue 6	0	2	= As In	= As In	100%	Wait For Go	Disabled	<input type="checkbox"/>	Linear		23:5

The Autoloaded playback will be fired when the cue starts, and killed when the cue list moves on to the next cue, unless you have also loaded the playback into the next cue.

You can set options for each Autoloaded playback by pressing the softkey where the Autoloaded playback is shown.

For a cue, the only option is [Remove this Autoload].

For a chase or cue list, softkey B lets you select whether to load the playback from the start, to start at a specific cue, or to press Go on the target playback.

9.1.4 Running a key macro from a cue list

You can program a cue within a cue list to trigger a key macro. This allows you to set up custom actions which can be performed when a cue in a cue list fires; for example you may want to lamp on your fixtures as the first cue in the cue list.

-
- 1> Press [Playback Options].
 - 2> Select the cue list.
 - 3> Select [Macros].
 - 4> In the Playback View window, select the step you want to add a macro to.
 - 5> Press the button(s) for the macro(s) you want to attach to the step. Or press [Add] and choose an action from the list.
 - 3> The "Macros" column shows the macros you have added.
-

- You can remove macros by selecting the cue, pressing the softkey for the macro you wish to remove and then pressing [Remove Link].

9.1.5 Keyboard shortcuts/syntax for cue lists

The following keyboard syntax can be used for fast cue list recording and editing. These commands work for the selected or currently connected playback where <n> is the cue number.

Record Cue, Connect, <n>, Enter (Record cue n)

- Copy, Connect, <n> (Copy cue n)
- Delete, Connect, <n> (Delete cue n)
- Include, Connect, <n> (Include cue n)
- Connect, <n>, Go. (Go cue n)

9.2 Cue List playback

9.2.1 Running a cue list

Raise the fader of the cue list and press the Go button to run the first cue. The bottom section of the display shows the cue list; the current cue is highlighted in grey and the next cue has a box round it.

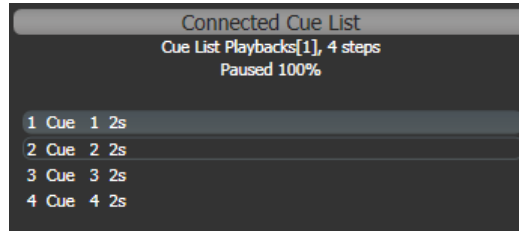

Also the display relating to the playback fader shows information about the cue list, including the current and next cue, fade progress of the current cue, and fade in/out times.

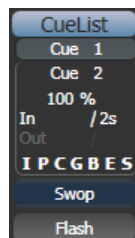

- The HTP levels of cues in the cue list are mastered by the fader level.
- You can pause a fade by pressing the Stop button above the Go button. Press Go again to resume the fade.
- You can skip to any cue in the cue list by selecting a “next” cue using Wheel A, or using the left/right arrow keys. When you press Go, the cue list will run that cue next.
- You can snap back to the previous cue by pressing the Snap Back button
- You can jump directly to a cue by pressing the Connect button, then typing in the desired cue number, then pressing Enter or softkey A. Alternatively at the top level menu you can type the cue number then press Connect.
- You can use Key Profiles to set the blue and grey buttons of the playback to have various functions including Go, Stop, Connect, Next Cue, Prev Cue, Cut Next Cue To Live, and Snap Back.
- When you lower the fader for a cue list, the HTP channels will fade out, but the cue list will remain active. The section below details how to kill the cue list.
- You can use timecode to play back a cue list automatically. See section 9.5.5 on page 165.

9.2.2 Killing a cue list

Once a cue list is fired, it remains active until you kill it. You do this by holding down the Avo Shift button and pressing the blue Select button of the cue list’s handle.

You can change this in the Playback Options to make the cue list automatically clear when the fader reaches zero (press [Playback Options] at the program menu, then press the Select button of the cue list, then select [Fader Mode Intensity Kill At 0]).

You can also use Key Profiles to configure one of the handle buttons to release the cue list.

9.3 Editing cue lists

9.3.1 Playback View window

The easiest way to edit a cue list is using the Playback View window (press View then the select button for the cue list to open it). This shows a grid with each cue and allows you to change most features of the cue. Click on the item you want to change in the grid, and the softkeys will offer you the different options.

To change multiple cues at once, draw a box across the items you want to change.

9.3.2 Editing values in Cue View window

You can edit the value of every fixture in each cue using the Cue View window. Press the View Cue button at the right hand end of the Playback View window.

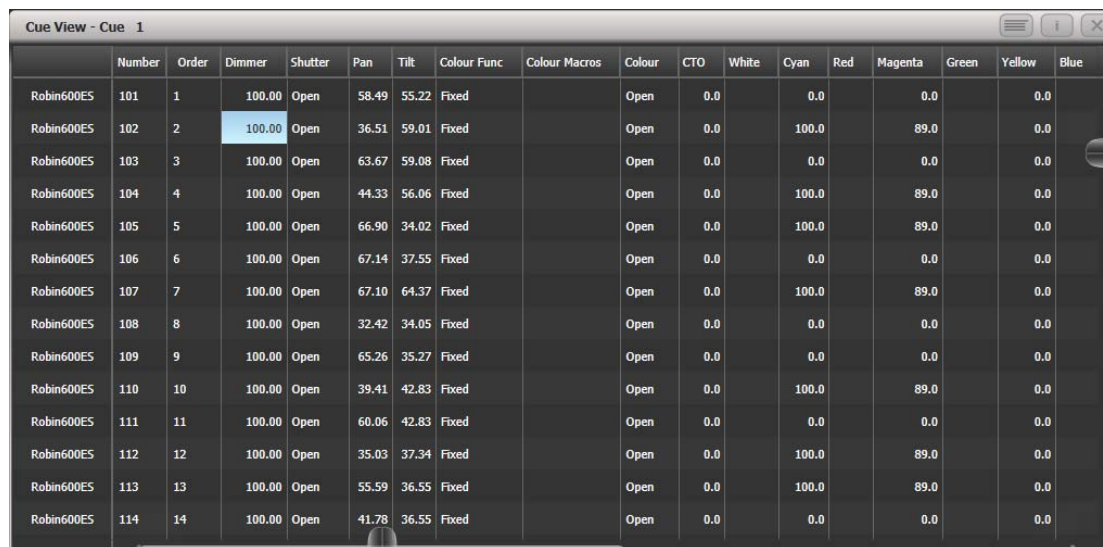

	Number	Order	Dimmer	Shutter	Pan	Tilt	Colour Func	Colour Macros	Colour	CTO	White	Cyan	Red	Magenta	Green	Yellow	Blue
Robin600ES	101	1	100.00	Open	58.49	55.22	Fixed		Open	0.0		0.0		0.0		0.0	
Robin600ES	102	2	100.00	Open	36.51	59.01	Fixed		Open	0.0		100.0		89.0		0.0	
Robin600ES	103	3	100.00	Open	63.67	59.08	Fixed		Open	0.0		0.0		0.0		0.0	
Robin600ES	104	4	100.00	Open	44.33	56.06	Fixed		Open	0.0		100.0		89.0		0.0	
Robin600ES	105	5	100.00	Open	66.90	34.02	Fixed		Open	0.0		100.0		89.0		0.0	
Robin600ES	106	6	100.00	Open	67.14	37.55	Fixed		Open	0.0		0.0		0.0		0.0	
Robin600ES	107	7	100.00	Open	67.10	64.37	Fixed		Open	0.0		100.0		89.0		0.0	
Robin600ES	108	8	100.00	Open	32.42	34.05	Fixed		Open	0.0		0.0		0.0		0.0	
Robin600ES	109	9	100.00	Open	65.26	35.27	Fixed		Open	0.0		0.0		0.0		0.0	
Robin600ES	110	10	100.00	Open	39.41	42.83	Fixed		Open	0.0		100.0		89.0		0.0	
Robin600ES	111	11	100.00	Open	60.06	42.83	Fixed		Open	0.0		0.0		0.0		0.0	
Robin600ES	112	12	100.00	Open	35.03	37.34	Fixed		Open	0.0		100.0		89.0		0.0	
Robin600ES	113	13	100.00	Open	55.59	36.55	Fixed		Open	0.0		100.0		89.0		0.0	
Robin600ES	114	14	100.00	Open	41.78	36.55	Fixed		Open	0.0		0.0		0.0		0.0	

You can then click on the values you want to change and edit them using the softkeys.

- The context menu buttons allow you to view levels, shapes, effects and times for each attribute of each fixture in each cue.
- If levels are set from a palette, the View Palettes button either shows you the palette used, or the underlying value.
- If the View Tracking Values button is selected, tracking values (values which have tracked through from another cue rather than being stored directly in this cue) are shown in light grey.

9.3.3 Moving and copying cues

You can copy or move cues within a cue list or to other cue lists. Either click and drag the cue in the Playback View window (press View

then the select button for the cue list), or use Unfold (next section), or you can use a command-line style series of keypresses.

Copy/Move within the same playback:

- COPY/MOVE <playback> <cue> [THRO <cue>] [NOT <cue>] [AND <cue>] @ <cue> ENTER
- COPY/MOVE <playback> <cue> [THRO <cue>] [NOT <cue>] [AND <cue>] ENTER <cue> ENTER

Copy/Move to the end of the same playback:

- COPY/MOVE <playback> <cue> [THRO <cue>] [NOT <cue>] [AND <cue>] @ @
- COPY/MOVE <playback> <cue> [THRO <cue>] [NOT <cue>] [AND <cue>] ENTER ENTER

Copy/Move to a different playback:

- COPY/MOVE <playback> <cue> [THRO <cue>] [NOT <cue>] [AND <cue>] [@][ENTER] <playback> <cue> ENTER

Copy/Move to the end of a different playback:

- COPY/MOVE <playback> <cue> [THRO <cue>] [NOT <cue>] [AND <cue>] [@][ENTER] <playback> ENTER
- COPY/MOVE <playback> <cue> [THRO <cue>] [NOT <cue>] [AND <cue>] [@][ENTER] <playback> <playback>

(<playback> is a playback swop key, <cue> is the cue number and sections in square brackets are optional)

9.3.4 Editing a cue list using Unfold

The Unfold button places each cue of the cue list on one of the playback faders. This allows you to fire and edit each step individually as if it was a stand-alone cue.

-
- 1> *Press the Unfold button, then the Select button of the cue list to be edited.*
 - 2> *The first 10 cues are loaded into the playback faders. The display shows the cue numbers and legends.*
 - 3> *Raise a playback fader to output the contents of that cue (fade times will operate as programmed).*
 - 4> *Various Unfold options are available, the details are below.*
 - 5> *Press Unfold again to get out of unfold mode.*
-

- To edit the contents of a cue: Press Clear to empty the programmer, raise the fader to output the cue, make the changes, press [Record Step], then the Select button for the cue number.
- To merge the programmer into the live step, double tap [Record Step].
- To change the times or cue linking for the cue, press [Edit Times], then the Select button for the cue, then set the times (see Timing on the following page)
- To Insert a new cue, set up the look for the new cue, press B [Insert Step], then press the playback button where you want the new cue to go. All following cues will be shifted on by one and the new cue will be given a number in between the two

existing cues (for example, if you press playback 3, your new cue will be 2.5).

- To move or copy a cue, press the Move or Copy button, press the select button for the cue you want to move or copy, then press the select button where you want it to go.
- To Delete a cue, press the blue Delete button then the Select button for the cue you want to delete. Press the Select button again to confirm.
- To change the cue legend, press [Set Step Legend] then the playback select for the step you want to change.
- If the cue list has more cues than there are playback faders, you can swop to the next page using softkeys F and G.

9.3.5 Using Update to change tracked cues

Because fixture settings in a cue list are tracked through from previous cues, if you want to edit a setting you need to find the cue where it was originally set.

The Update function will go back through the cue list from the currently fired cue and automatically update the correct cue.

-
- 1> *With the cue list fired, select the fixtures and change them to the settings you want to store.*
 - 2> *Press Record Cue, [Update].*
 - 3> *Press Enter to immediately store the new values to the cue list. Alternatively, the softkeys show a list of palettes and playbacks which can be updated. Select or deselect these as required.*
 - 4> *If you have used the softkey options, press Enter to complete the update.*
-

- If the attributes you have changed were tracked through from a previous cue, Update will update that cue rather than the current one.

9.3.6 Editing a cue list which is running

You can also edit cues in a cue list while you are running it without using Unfold.

-
- 1> *Fire the cue list by raising its fader.*
 - 2> *Use Wheel A to select the cue number you want to change then the white ↔ button above the Snap Back button to jump to it.*
 - 3> *Press Clear to make sure the programmer is empty.*
 - 4> *Make the changes that you want to the current step.*
 - 5> *Press Rec. Step, then select [Replace], [Merge] or [Insert After] to save the changes (pressing Rec.Step again will select Merge).*
 - 6> *Press the white ↔ button to jump on to the next step.*
-

- You can edit the times for a cue using the Live Time and Next Time buttons as follows:

-
- 1> *Fire the cue list by raising its fader.*

- 2> Use Wheel A to select the cue number you want to change then the white ↔ button above the Snap Back button to jump to it.
- 3> Press the Live Time button to set the times for the current step, or the Next Time button for the next step. The Live and Next step numbers are shown on the display above the controller wheel.
- 4> Use the softkeys to set the times, linking and overlap settings you want (see section 7.5.1 on page 135 for description of the times). If you set the [Link to next step] option to On, then the next cue will not wait for the Go button.
- 5> Press the white ↔ button to jump on to the next step.

- The Review button lets you test the live step with the new timings.
- You can also use Unfold to set the times as described in the Unfold section above.

9.3.7 Editing a cue list while recording

You can edit cues while you are in the Record Cue List menu.

- 1> Press [Cue Number=x] and type the cue number to be edited.
- 2> The console will jump to the cue and show the output.
- 3> Make the changes that you want to the programming of the current step, or to the timings using [Edit Cue x Times].
- 4> Press [Update Cue x] to save the changes.

- You can't change the cue number using this menu – if you press [Cue Number] this will change the cue you are editing. Use [Advanced Options] to change cue numbers.

9.3.8 Disabling a cue

You can temporarily disable a cue using the Disable option at the right hand end of the Playback View window. Select the Disabled box and the softkeys let you set [Cue Disabled]. When a cue is set to Disabled it will be skipped. This can be a useful way to remove a cue, but still be able to put it back in later.

9.4 Copying, moving, linking and deleting

This section tells you how to copy or move the entire cue list from one playback to another. For details of copying and moving cues within a cue list please see the previous section.

9.4.1 Copying or moving a cue list

Cue lists can be copied or moved to a new playback, or you can create a linked copy of a playback. Move is useful for tidying up the console.

This operation is exactly the same as for Cues and is described in detail in section 7.4.1 on page 134.

9.4.2 Deleting a cue list

You can delete a whole cue list by pressing Delete then the Select button of the playback to be deleted. Confirm the deletion by pressing the select button again, the [Confirm] softkey, or Enter.

9.4.3 Deleting a cue from a cue list

To delete a single cue from a cue list:

-
- 1> Press the Delete button.
 - 2> Press the Swap button of the cue list.
 - 3> The cues in the cue list are listed on the screen. Use the left hand wheel to select the cue you want to delete, or type in the number of the cue to be deleted.
 - 4> Press [Delete Cue x] to delete the cue.
 - 5> Press [Confirm] to confirm the delete.
-

- Alternatively you can use the Unfold function to delete a cue from a cue list.

9.5 Cue list timing

9.5.1 Time and fade options for Cue Lists

Time settings are independent for each cue in the cue list. The display shows which cue you are working with. You can select which cue is active using Wheel A or softkey A of the Cue Times menu.

See the diagrams in section 7.5.1 on page 135 and section 8.5.2 on page 150 for more information about overlaps and fade times.

-
- 1> Press A [Edit Times] at the main Program menu then the Swap button of the Cue List.
 - 2> To change which cue you are editing, scroll through the list using Wheel A or press [Cue Number] then type the cue number you want to edit and press Enter. The Chase arrow buttons to the right of the Connect button also step through the cues.
-

- You can select a range of cues, enabling you to alter the timings of multiple cues all in one go, by using Wheel B, or in the Playback View window, dragging across the cues you want to select in the grid.
- To set the delay time between pressing Go and the cue starting, press [Delay In] then type a time in seconds and press Enter.
- To set the fade in time of the cue, press [Fade In] then type a time in seconds and press Enter. Both HTP and LTP channels are affected by the fade.
- The fade out time of the cue is set by default to be the same as the fade in time. You can change the fade out time by pressing [Fade Out], then type the time in seconds and press Enter. To set equal to Fade In time, delete the time and leave the box blank.
The fade out time starts when the next cue fires, so if you set the time to 1 second, the outgoing cue would start a 1 second fade out as the new cue begins its fade in.

- The [Delay Out] setting of the cue would normally be used if the console links automatically to the next cue, and sets a wait time before the next cue starts its fade in. So the outgoing cue would start to fade out, and the delay out time would run before the new cue begins its fade in.

9.5.2 Cue linking & Link Offset

Cues in cue lists may be linked together, allowing you to build up complex self-timed sequences. The link options are set using the softkeys and are:

- [Link Wait For Go]: the cue waits for the Go button to be pressed then fires immediately. Link Offset is disabled.
- [Link After Previous Cue]: The cue fires when the previous cue has finished its delay in and fade in times. A Link Offset can be set to add a delay between the previous cue finishing and this cue firing. The offset can be given as a time in seconds, or as a percentage of the fade time of the previous cue.
- [Link With Previous Cue]: The cue fires at the same time as the previous cue fires. A Link Offset can be set to add a delay between the previous cue firing and this cue firing, set either in seconds or as a percentage of the fade time of the previous cue.

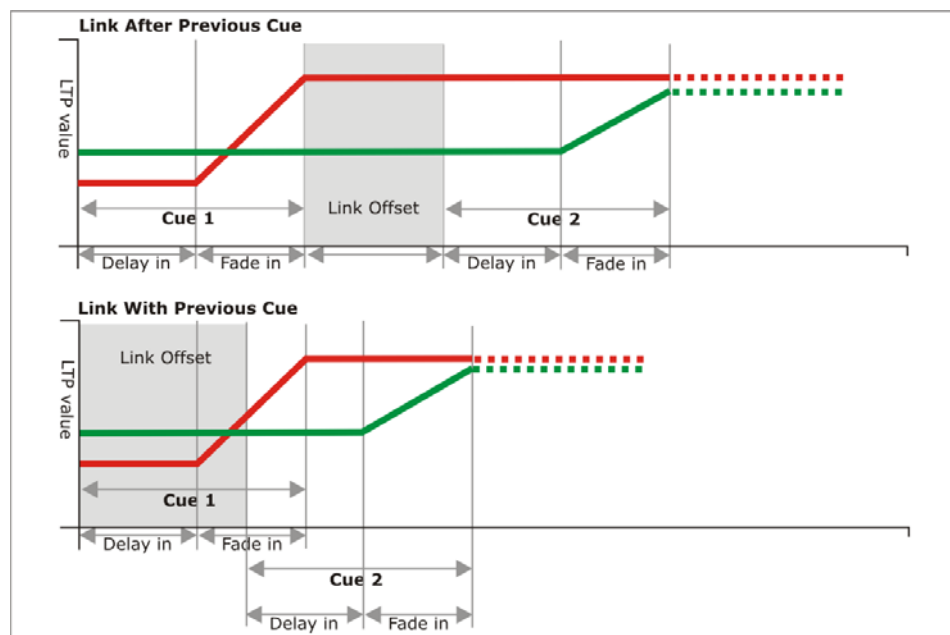

These options allow you to create complex self timed sequences by building up simple steps. For example if you wanted the following effect:

- Go is pressed, fixture one starts fading up over 20s
- After 10s fixture two fades up over 15s
- Both lights stay on for 5s
- Both lights go off in 3s

You could program

- Cue 1 - Fixture 1 @ 100%, Fade In 20s, Link Wait For Go

- Cue 2 - Fixture 2 @ 100%, Fade In 15s, Link With Previous, Link Offset 10s
- Cue 3 - Fixture 1 AND 2 @ 0%, Fade Out 3s, Link After Previous, Link Offset 5s



To obtain the effect which was called “cue overlap” in previous versions of software, use [Link With Previous Cue] and set a percentage Link Offset time. Link Offset of 100% is equivalent to Cue Overlap of 0% and vice versa.

9.5.3 Individual attribute fade times

You can set individual fade times for each IPCGBES attribute group. You can also select which fixtures this is applied to. For example you can make the position change take 2 seconds, but the colour change take 10 seconds.

Additionally you can set individual times for each attribute so you could make the pan fade over a different time to the tilt.

To set times for an attribute group, first select the Set Times menu and go to the cue you want to set as described above, then press G [Next] to go to the second page of options.

-
- 1> Press C [Attribute times].
 - 2> All fixtures in the cue will be selected. If you don't want to change the times for any fixtures, deselect them now. You can press the ALL button (below Next Time) to select all fixtures in the cue or Shift+ALL to deselect all fixtures.
 - 3> Press the softkey for the attribute group you want to change.
 - 4> Press A [Delay] to set the delay time, or press B [Fade] to set the fade time. Press G [Use global] to remove the attribute group timing and go back to the normal delay/fade times for the cue.
-

- You can use [Individual Attributes] to set times for one attribute within the group, for example just Pan from within the Position group. You can also use the Cue View window to set times for individual attributes.

9.5.4 Fixture overlap

For each cue you can set a (linked together) fixture overlap, which causes the Tiger Touch to apply the settings in the cue to each fixture sequentially giving a “rolling” change across the fixtures in the cue. This can create some great effects without much programming on your part.

- Press A [Fixture Overlap] (on the second page of the Cue Times menu) then enter 0-100 on the keypad to change how fixtures overlap in the cue. 100% means all fixtures fade together (the normal setting). 0% means that the first fixture will finish its fade before the next one starts. 50% means that the 2nd fixture will start fading when the first one is half way through its fade.
- To change the fixture order when using overlap, press D [Set Fixture Order]. Normally this is the order in which you selected

the fixtures when you programmed the cue. The Fixture window shows the fixture order in large green numbers. Reorder the fixtures by pressing A [Step Number] then type the start number on the numeric keys, then press the fixture Select buttons in the order you want them. For example, to set the order of 8 fixtures, press 1 on the keypad, then press the Select button of the fixture to be first, then the Select button for the second, and so on. You can set several fixtures to the same number if you want them to change simultaneously. If you press a fixture button twice, it will show X and be excluded from the sequence. Press Exit to finish setting the fixture order.



9.5.5 Running a cue list to timecode

The console can run a cue list automatically to a timecode. This is very useful for complex performances which must be exactly the same time after time, or for unattended operation. Each step in the cue list is assigned a time at which it will run.

The timecode can be read from the system clock, from an internal timecode source, from MIDI or from Winamp. Internal timecode is useful for programming a sequence which will later be triggered by an external timecode source.

-
- 1> *Connect the cue list for which you want to set timecode.*
 - 2> *Press [Timecode] on the top-level menu.*
 - 3> *Press softkey A to select the desired timecode source.*
 - 4> *Press [Record].*
 - 5> *Start the timecode source. If using internal timecode, press [Play] to start it.*
 - 5> *Press the red Go button to step each cue at the time you wish the cue to start.*
 - 6> *Press [Record] when you have finished.*
-

To play back a timecoded cue list, press [Connected Cue Lists] and select the cue list which is to be played. Then press [Timer Disabled/Enabled] to enable the timecode input.

When you start the timecode source (or press [Play] if using internal timecode), each cue will fire as the timecode matches its programmed time.

You can edit the timecode for each cue by using Wheel A to select the cue, then press Enter and type the new timecode for the cue.

ad	Curve	Autoload	Timecode	Notes	View
	Linear		00:00:00.24		V
	Linear		00:09:00.00		V
	Linear		00:12:00.00		V
	Linear		00:25:00.24		V
	Linear		23:59:59.24		V
	Linear		23:59:59.24		V

While editing a time you can also use Wheel B to select multiple cues, and use the softkey options to enter a value to change the time of all the cues (offset, add a fixed time or subtract a fixed time).

You can open a timecode display window to show you the incoming timecode – press [Open Workspace Window] then [Timecode].

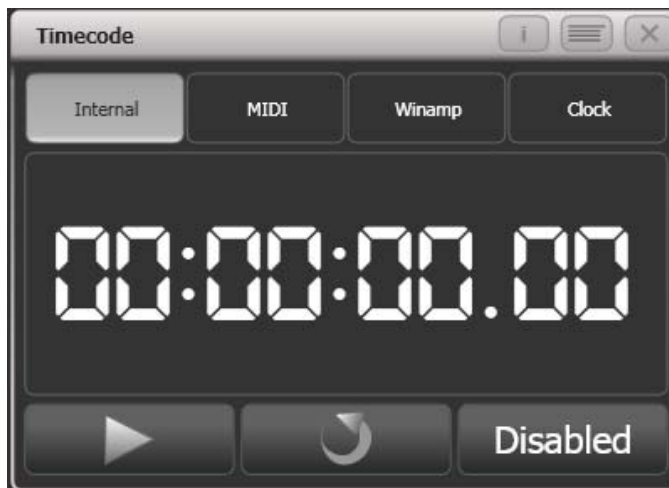

9.6 Advanced options

Advanced cue list options are set from the Playback Options menu. You can enter the playback options menu by doing the following

-
- 1> At the top level menu press [Playback Options].
 - 2> Press the select button for the cue list you wish to edit.
-

9.6.1 Release mask

[Release Mask] lets you specify using the softkeys which attributes will be released back to their state in other live playbacks when the playback is killed. You can also use the Attribute Bank buttons on the right side of the console to set the mask. The default setting is to not release any attributes.

9.6.2 Fader mode

This option sets how the cue list fader behaves. If set to [Fader Mode Intensity Kill With Off], the fader masters the overall HTP level and the cue list remains active (connected) even when the fader is lowered to zero. If set to [Fader Mode Intensity Kill At 0], the fader masters the overall HTP level and the cue list is killed when the fader is lowered to zero. If set to [Manual Crossfader] the fader behaves as a manual crossfade control, and the cue list will automatically step on to the next cue when the fader reaches the top or bottom of travel.

9.6.3 Handle Paging

This option allows you to lock the playback on a handle so that it always appears on that handle no matter what page is selected.

If you select "Transparent Lock" then the playback will appear on the current page if no other playback is programmed in that position.

9.6.4 Cue Options

This option allows you to change settings for each cue in the cue list. To select the cue number to edit, use the left hand wheel or press softkey A then enter the cue number on the numeric keypad.

- [Curve] allows you to set a different fade curve for the cue; this affects how the fade progresses from one cue to the other (for example you can select a fade which starts off slow, speeds up in the middle and then slows down at the end). Press [Curve] then select a new curve from the softkeys. The effect of the various curves is described in section 12.5 on page 198.
- [Link] can be set to Wait for Go, With Previous Cue or After Previous Cue. See section 9.5.2 on page 163.
- [Move in Dark] opens the menu for Move In Dark options, see section 9.6.10.
- [Move In Dark Inhibit] disables the Move In Dark function for this cue.
- [Tracking] disables or enables tracking for this cue.
- [Legend] allows you to set a legend for the cue which is displayed on the cue list display.
- [Notes=] lets you enter a note for the cue ("Leaves stage pursued by bear" or "wake up spot operator").
- [Autoload] see next section
- [Cue disabled] allows you to temporarily disable this cue, see section 9.3.8.

9.6.5 Autoload

This option allows you to automatically load a playback with a cue and is described in section 9.1.3 on page 155.

9.6.6 Macro Links

You can link a key macro to each cue in a cue list. See 9.1.4 on page 156.

9.6.7 Key Profile

Each playback can have an individual Key Profile allocated to it. This allows you to customise the panel button functions differently for each playback. A list of available Key Profiles is shown, or you can add a new one. The softkeys show the function allocated to the blue and grey buttons for each of the available Key Profiles.

If the playback Key Profile is set to “None”, the default global profile is used.

9.6.8 Shape Size/Shape Speed

These options allow you to set whether shapes in the cue list are replayed at fixed size/speed, or whether this should be set by the playback fader position.

9.6.9 Tracking

Tracking mode (where each cue depends on the state of the previous cue) may be changed using this option.

Settings are:

- [Block]: the cue will not take tracking states from previous cues. All subsequent cues will track from the Block cue.
- [This Cue Only]: changes in this cue will not track to subsequent cues. Unchanged states from previous cues will be restored in subsequent cues.
- [Solo]: No states are tracked into or out of a solo cue. States from previous cues will track to subsequent cues but will not appear in the solo cue.

9.6.10 Move In Dark (MID) functions

When using moving lights in theatre, often you would like them to be positioned ready for the next cue so that you do not see them moving. The Move In Dark function does this by automatically positioning the fixture for the next cue when it is not lit.

Move In Dark options can be set either for the whole cue list or for individual cues.

Options for the whole cue list are set by pressing [Playback Options] then the select button for the cue list, then [Move In Dark].

- [Disabled] prevents Move In Dark functions for all cues in the cue list regardless of the individual cue settings.
- [Early] will attempt to position a fixture as soon as possible unless overridden in an individual cue.
- [Late] will position the fixture as late as possible.
- [Off] turns off Move In Dark unless enabled in individual cues (default).

For individual cues the options are set using the Playback Window.

- [Global] uses the cue list’s global setting (default)
- [Cue Number] specifies a cue where you would like the move to occur

- [Cue Offset] specifies a preferred number of cues in advance
- [Disabled] prevents Move In Dark for this cue
- [Early] will move as early as possible
- [Late] will move as late as possible.

Move In Dark delay and Move In Dark fade times can be set for the whole cue list or for each cue using the Set Times menu. Each cue also has a Move In Dark Inhibit option which prevents any movements during that cue (useful if you need to prevent fixture noise).

If the fixture has its intensity above zero or Move In Dark is inhibited when the Move In Dark is supposed to occur, the console will attempt the movement in the nearest suitable cue instead.

9.6.11 Fire first cue option

When this option is enabled, the first cue of the cue list will immediately go when the fader is raised. The default is Disabled.

10. Running the show

So, it's showtime. This chapter describes the functions of the console which are useful when running a show.

10.1 Playback controls

10.1.1 Back up the show

At regular intervals while you are programming, and when you have finished programming (or you've run out of time) and it's showtime, the most important thing is to save the show (see section 2.3.6 on page 32 for instructions). It is important to also back up the show by saving it to a USB drive, enabling you to swap to a different console if there are problems.

10.1.2 Label the console

When you are running your show you will need to know where everything is. Use the Legend functions to set onscreen labels, or you can't beat the low tech method of marker pen and tape.

10.1.3 Run mode

If your show is fully pre-programmed and you wish to avoid accidental modifications, switch the mode switch to Run. This prevents anyone from altering the programming of the console. However the operator can still select fixtures and adjust attributes live.

For busked shows it's often useful to run the console in Program mode to allow updating of the programming as the show progresses.

The main differences between Run mode and Program mode are:

- In Program mode, preset faders go into the programmer and take over the output, but in Run mode they do not.
- Run mode provides quick access to different Key Profiles.

Run mode provides a tap tempo button.

10.1.4 Grand Master fader

In the bottom left hand corner of the console is the Grand Master Fader. This controls the intensity of all output from the console. Normally you would set this at full, and use it if you need to quickly fade out all the lights.

The Grand Master fader is disabled by default. It can be enabled in the user settings if required.

10.1.5 Assignable Master faders

Any playback fader on the console can be assigned to be a master fader, which allow you to set the overall intensity of various areas of the console. Different types of master fader are available:

- Grand Master controls the intensity of all output from the console.
- Swop and Flash masters control intensity of the swop/flash buttons
- Preset master controls intensity of the preset faders
- Playback master controls intensity of all playbacks.

To assign master faders, go to System mode and select [Assign Mastering].

By default, master faders are set to have a transparent lock, which makes the master fader remain in position even when the playback page is changed. If you don't want this to happen you can change it by pressing [Playback Options] from the root menu then press the Swop/Select button of the master.

10.1.6 Speed Masters

Playbacks can be assigned to a Speed Master which allow you to control the speed of shapes or effects stored in a cue (or in the case of chases, to modify the speed of the chase).

There are eight possible Speed Masters which allow you to separately control the speed of different playbacks, if you need to.

A playback is assigned to a Speed Master by pressing [Playback Options] then [Speed Source]. The following speed sources are available:

- Local (default - no Speed Master)
- BPM 1-4 (override the local speed with a fixed value from the master)
- Rate 1-4 (proportionally modify the local speed using the master)

There is also a Rate Grand Master which, if used, proportionally controls the four Rate Masters (BPM Masters are not affected).

To use Speed Masters you will need to assign some handles on the console to act as the Speed Master faders. Switch the console to System mode and select [Assign Mastering]. Special key profile options are available for Speed Masters, BPM Masters default to Tap Tempo.

10.1.7 Group Masters

You can assign a fader to control the master intensity of each fixture group. To do this you simply save (or move) the group button to a handle with a fader.

The blue button will then select fixtures in the group and holding the blue button gives you softkey options to filter the selection according to a pattern.

Using the [Playback Options] command you can set the fader mode to the following:

- Scale master (proportional control)
- HTP (override level if higher than current output)
- Limit (sets hard limit)

- Take Over (place fixture and its intensity in programmer when level matched)
- Disabled (ignore fader)

If the playback fader has a display area on the screen, the level and mode of the master will be shown.

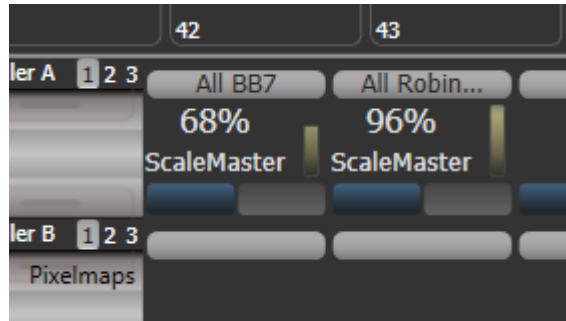

- When a group master is set to disabled or moved to a handle without a fader, it will become locked at the current fader level. Re-enable or move back to a fader to adjust the level.

10.1.8 Flash and swop buttons

The Flash and Swop buttons on the playback faders may be used at any time to flash and solo cues and chases. The Flash button adds the playback into the current output, the Swop button turns off all other output. . The Flash button can also be set to Flash With Times which will use the pre-programmed timings of the cue when flashing.

You can reallocate the functions of the Flash and Swop/Select buttons on the console using Key Profiles – see section 12.3.4 on page 195. A useful alternative function is Preload which allows you to pre-position the attributes of the fixtures before you raise the playback fader, which is handy for avoiding unwanted movements (any fixtures which are already active in another playback will not change when you use Preload). You can also allocate Go and Stop buttons for cue lists and chases. To quickly change the key profile, hold Avo Shift and press [Edit Key Profile].

The screen relating to each playback faders shows the allocated function of the blue and grey buttons.

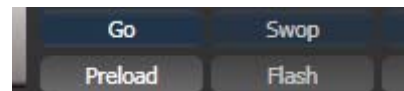

10.1.9 Playback priority

You can set playbacks to high priority if you do not want them to be overridden by other playbacks using the same fixtures. For example, if you have a couple of fixtures acting as a spotlight, but they are also programmed into some colour washes, you probably want the spotlight cue to take priority over the colour washes. See section 7.6.5 on page 140.

10.1.10 Preset playbacks

As well as the 10 playback faders across the bottom of the console, there are 10 further playbacks on the top right of the console. These are not affected by the playback page buttons and so are useful for memories you use a lot, such as par can washes, basic stage illumination or smoke machines.

You can switch to different pages for the preset playbacks using a factory-preloaded macro in two of the Macro/Executor buttons. This macro is loaded with the Personality Library, if you do not see the page macros you need to update the library.

10.1.11 Locking a playback onto the same handle on every page

Sometimes you might want to keep a playback accessible on a handle no matter which page you are on. The [Handle Paging] option in the [Playback Options] menu lets you do that without having to copy the playback onto multiple pages.

[Locked] ensures the playback always appears on that handle no matter what page is selected. Any other playbacks programmed on that handle on other pages will not be accessible.

[Transparent Lock] means the playback will appear on the current page only if the handle is empty on that page. If a playback is programmed in that position on the new page, then that playback will appear instead of the locked one. This can be useful if you only need the locked playback to appear on certain pages but wish to reuse the handle on other pages.

You can also lock Macros stored on the macro/executor buttons which is useful with the Macro page change buttons.

10.1.12 Viewing active playbacks

The Active Playbacks window shows details of which playbacks are active. This provides an easy way to see what is currently running.

The top line of the button shows the page number and tells you where on the desk the playback is stored. The second line shows the legend, and the third line shows which attributes are affected by the playback.

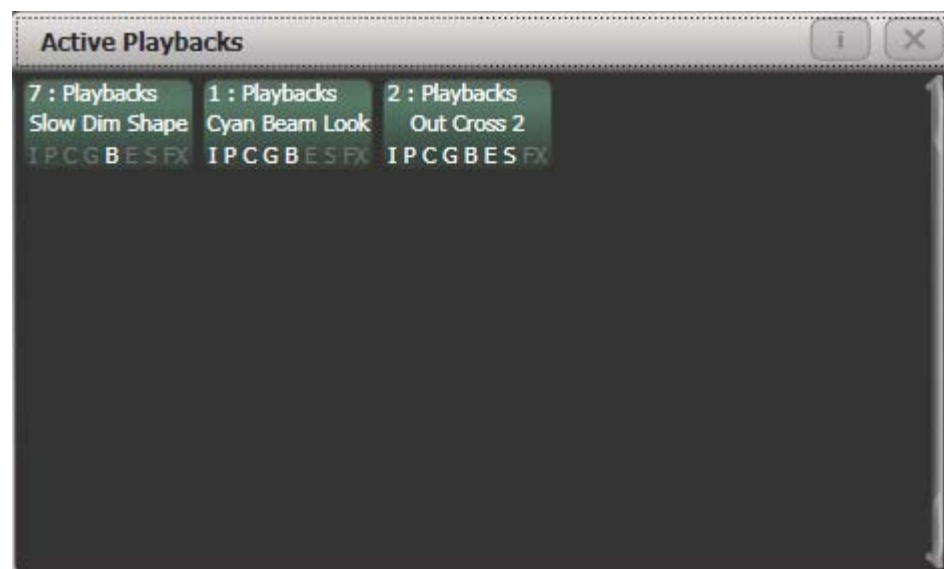

Click on a playback to instantly kill it. You can also press [Playback Options] followed by the playback in this window to change parameters of the playback.

10.1.13 Blind mode

You can set the console to Blind mode by holding down the Avo button and selecting [Blind]. This allows you to program cues using the Visualiser window without affecting the look on the stage.

10.1.14 Busking with palettes

If you have not had as much programming time as you would have liked, you might need to make up some additional effects during the show. This is sometimes called "busking", and is where the fun starts!

You can create instant variations by recalling palette values to modify your existing cues. The console can fade to the palette values for added effect.

-
- 1> *Select some fixtures which are already in use on stage.*
 - 2> *Type "2" (or any time, in seconds) on the numeric keypad.*
 - 3> *Touch a Palette button to recall a palette.*
 - 4> *The selected fixtures will change to the new palette over a time of 2 seconds.*
-

If the palette contains programmed times, you can change the Key Profile of the palette button to set whether the programmed times will be used or not. (Press Avo Shift+[Key Profiles], then [Palettes] to set the key profile). Options are [Palette is fired ignoring its times] or [Palette is fired with its times]. You can also set whether the palette will take precedence over a flashed cue or not. A time entered manually as above will always override a programmed time.

When a fade is entered, you can also change the "Fixture Overlap" using softkey A. This allows you to create "roll" or "peel" effects when using a series of fixtures. With overlap=100%, all fixtures change at the same time. If overlap=50%, the second fixture will not start its fade until the first fixture is half way (50%) through fading. The order of the fixtures is set by the order in which you selected them.

The palette fade time remains active while the Palette Fade menu is open. Press Exit to leave the menu and return to instant palette recall.

If you apply a palette with a fade time, then it will be overridden by the next cue (so if you fade to green using a palette, then fire a cue which sets those fixtures blue, they will go blue). If you apply a palette without a fade time, it will go into the programmer and override any subsequent cues (so if you use a green palette with no fade, the fixtures will be locked in green until you press Clear).

Having the palette overridden by the next cue is quite useful when "busking". If you need to "snap" a palette but still have it overridden by the next cue, set a fade time of 0 (leaving the Palette fade menu open).

When programming your palettes, group all the colour palettes in one area of the console, position palettes in another area, and so on. This helps you to find them when the show is running and the pressure is on.

If you are lighting a band, make position palettes for every person on stage so you can spotlight them for those unplanned solos.

You can use the Off function (see section 7.3.5 on page 133) when programming to set some cues to only affect position, and other cues to set colours, gobos, add shapes, and so on. By combining two or more cues you can produce a much wider range of effects than if all your cues set all the attributes. However, for this to work well you need to make sure you know what attribute is going to be affected by each cue; as if you fire two “colour only” cues then nothing is going to light up.

10.2 Using multiple on-screen workspaces

On the screen you can configure different “workspaces” which store how the various windows are displayed. This allows you to quickly recall different setups. Workspaces are stored and recalled from the touch buttons to the left of the menu buttons.

10.2.1 View menu

Pressing View (by numeric keys) takes you into the View menu. From here you can set up what is shown on the touch screen and the external monitor.

- [Window Options] allows you to reposition and resize windows, and to move them between screens.
- [Open Workspace Window] gives a list on the softkeys of all the possible windows, allowing you to open the one you need.

10.3 Organising the console

If the layout of the fixture buttons, palettes or playbacks has become a bit mixed up during programming, you can use the Move function to move recorded items around and produce a better layout. When an item is moved, all links to other recorded items are retained.

10.3.1 Using the Move function

To move fixtures, palettes, groups and playbacks is very simple.

-
- 1> Press Avo and the Copy/Move/Link button to select Move mode.
 - 2> Press or touch the select key(s) of the item(s) to move.
 - 3> Press or touch the select key of the destination.
-

When moving a range, it is possible to select a range containing different types of items, and there can be gaps between them. In this case, you can set option B to [Bunch Up] to have all of the gaps in the range removed.

[Swap Items if Required] will attempt to reposition any existing handles which are in the way of the move. This is useful when rearranging handles on a page which is nearly full.

- If there is not enough space, (there is an item in the way or there is not enough space before the end of the page) then the action will not be completed.

10.4 Set List window

The Set List window is a handy way of linking playback pages to songs/events in your show which you can then easily step through.

You can also make notes, handy for avoiding bits of paper lying around. You can have multiple set lists in a show.

The Set List feature works best if you have a page of playbacks for each song in the show.

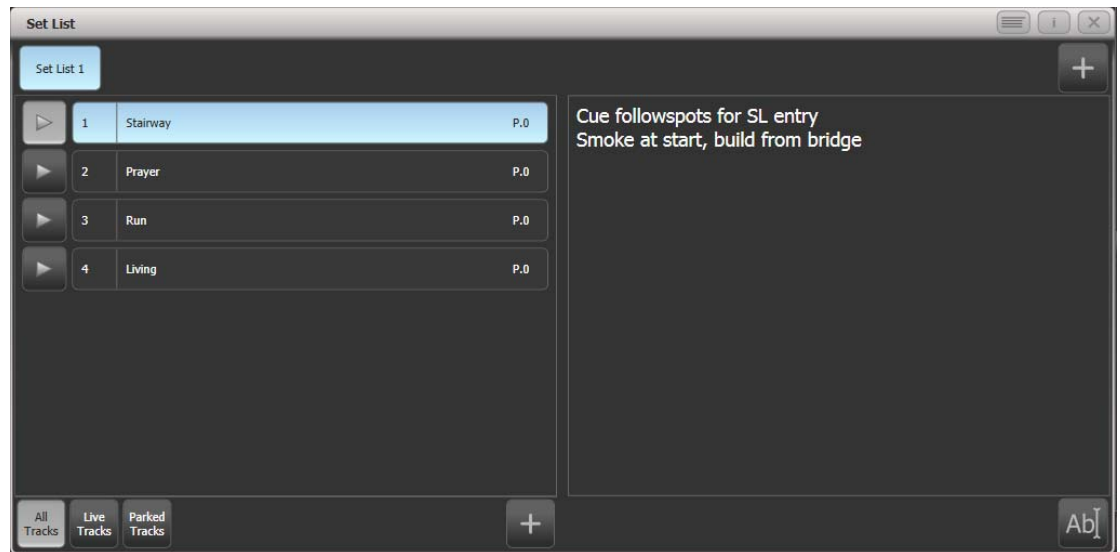

A set list is made up of tracks. When a track is added it automatically links to the current page. Pressing the play button next to the track will automatically select the correct playback page (except on Pearl Expert, because the rollers cannot be moved automatically).

To create a Set List, click the plus button in the top right corner of the window. You can choose Empty, Pages, and Build. Pages will automatically create a set list using the legends of your existing playback pages, one page per track. Build allows you to select the pages in the order you want them. Or you can manually add a track using the plus button below the track list.

Enter notes by selecting a track and clicking the notes button, bottom right, or the Edit Note context menu button.

- You can temporarily remove a track from the set list using the Park Track context menu button.
- If you prefer to operate by using the Page+ /Page- buttons, you can change the function of these buttons to step through the tracks in the set list window, using the Page Mode context menu button. When Page Mode is set to Set List, the Page+ /Page- buttons are reassigned to step through tracks in the Set List, and the playback pages will automatically change as programmed in the Set List. Set Page Mode to Normal to restore normal operation. (Not available on Pearl Expert).
- You can copy, move or delete tracks using the appropriate function buttons on the console.
- You can change the legend of the Set List or of individual tracks using the [Set Legend] option.

10.5 MIDI or DMX remote triggering

You can set up the console to allow most features to be triggered by external events. This is very useful in complex shows or when using in an automated setup.

10.5.1 Connecting remote trigger sources

To connect a MIDI source, connect it to the MIDI in connector on the console.

DMX inputs are connected to one of the DMX output connectors using a DMX male to male gender changer cable. (This is a simple plug to plug cable with all pins wired straight through, i.e. 1-1, 2-2 and 3-3).

10.5.2 Setting up remote triggering

Enter System mode and select [Triggers]. The Triggers window will open.

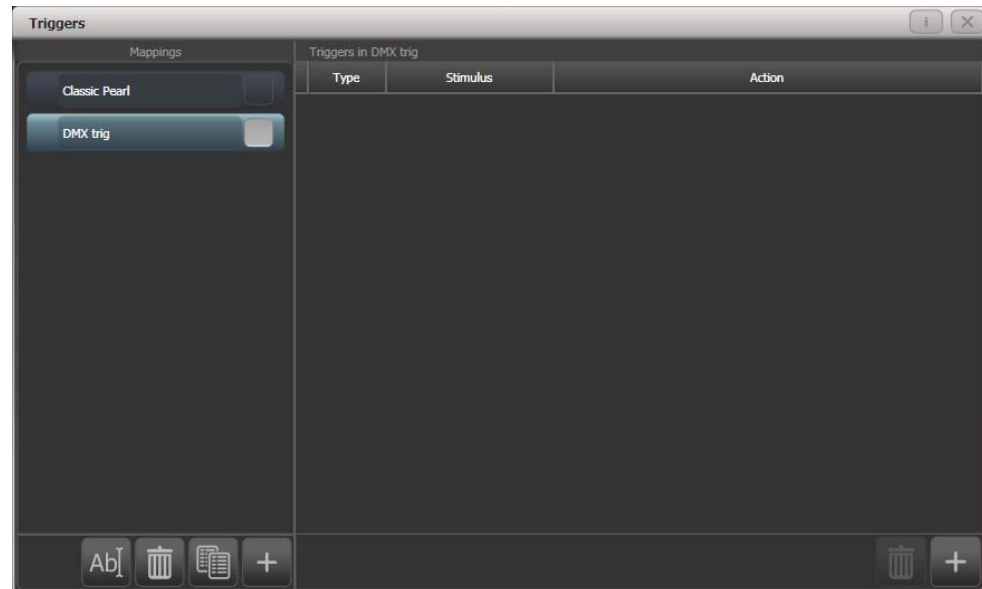

The left hand side of the window has a list of trigger sets. The “classic Pearl” MIDI trigger implementation is provided as one of these. Each set of triggers can be enabled or disabled using the button at the right hand end of the mapping name.

- 1> Add a new mapping using the + button at the bottom of the left hand column, and enter a name for it.
- 2> Add a trigger to the mapping using the + button in the right hand column or softkey [Add trigger].
- 3> Select [Trigger Type] as [Hardware] to trigger a physical button press or fader move, or [Item] to trigger a screen button (playback, fixture, palette, group or macro).
- 4> Press the button or move the fader to be triggered. The screen will update to show you what has been triggered. For Item triggers you can select different actions using the [Action] softkey.
- 5> Press [OK]. You have now set up the console action which is to be triggered.
- 6> Now you need to set up the external stimulus which will cause the trigger. Select [Trigger Type] as DMX or MIDI. For DMX, press [DMX Port] to select which DMX port you are using for DMX input. You will need to switch the DMX port to Rx mode using the menu option provided.
- 7> Generate the stimulus from your device (for example play the MIDI note, or turn on the DMX channel). If the [Learn] option is

set to On, the console will automatically detect the stimulus. Or you can enter the details using the softkey options.

- 8> For DMX triggers you can select the address for triggering. For MIDI triggers you can select MIDI channel, MIDI Command, Value, and Level (velocity) ranges.
- 9> Press [Add] to add the trigger to the list.
- 10> The window will show the trigger stimulus and the action to be carried out.

You can continue to add other triggers to the mapping.

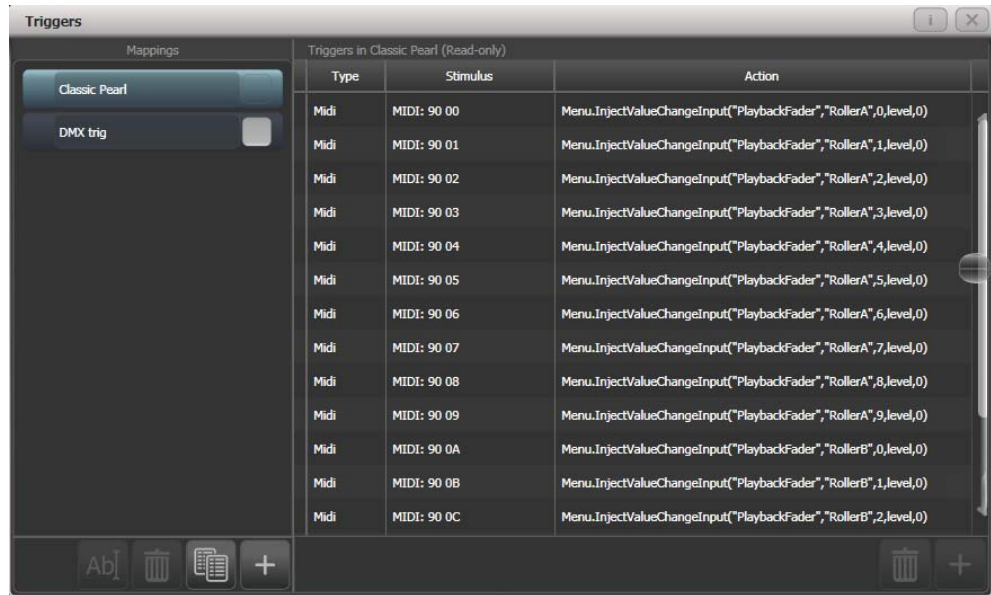

To delete a trigger from the mapping, select it in the list and press the rubbish bin button at the bottom.

To delete a complete mapping, select it and press the rubbish bin button at the bottom of the left hand column.

10.5.3 Classic Pearl MIDI triggers

This trigger map sets up the console to mimic the MIDI setup of the classic Pearl software. It is used for triggering playbacks from MIDI.

In this section MIDI commands are shown in hexadecimal using the \$ sign, for example \$Cn, where n represents the MIDI channel being used. n is a number from 0 to 15 representing MIDI channels 1 to 16. So to send "program change value 4 on channel 2" you would send \$C1 \$04 (193 004 in decimal).

Most MIDI equipment or software will do all this for you without you needing to know about the numbers.

Set playback page : program change (\$Cn xx)

Page	1	2	3	4	5	...	28	29	30
xx	\$00	\$01	\$02	\$03	\$04	...	\$1B	\$1C	\$1D

example \$Cn \$02 Console changes to Page 3

Turn on a playback: *note on (\$9n pp ll)*

Note number (pp) = playback number, from 0 - 14 (decimal)

Key velocity (ll) = playback level, from 0 - 127 (decimal). 127=Full

example \$9n \$03 \$40 Playback Fader 4 at 50% level.

(Note that Playback Fader numbers start at zero, so subtract one from the number on the console to get the MIDI note number).

To turn off a playback, send a note on command with velocity=0. The console does not recognise MIDI note off (\$8n) commands.

Stop/run/step a chase etc: *after touch (\$An pp cc)*

Note number (pp) = playback number, from 0 - 19 (decimal)

Aftertouch value (cc) = control codes:

- \$00 stop chase
- \$01 run chase
- \$02 restart from step 1
- \$03 fade to next step using programmed fade times
- \$04 snap directly to next step

10.6 Running a second console as backup

On many shows it is important to have a backup console running in case the main console fails during the show. Titan allows you to run a second console over the network which it keeps synchronised with the main console. Should the worst happen, a single keypress can transfer control to the backup console.

10.6.1 Setting up consoles for backup

Any Titan console can act as backup for any other console, they do not have to be the same model. For example you could run Titan Mobile as backup.

However do think about what parts of your show you will not be able to access if the backup device has less faders/handles than the main console.

-
- 1> *Connect both consoles to the same network and ensure they are set to the same IP range (see section 14 on page 209).*
 - 2> *Press Disk, [TitanNet Sessions (Backup)].*
 - 3> *Consoles available for backup will be listed in the softkeys.*
 - 4> *Selecting a console will place that console into backup mode and sync the show to it.*
 - 5> *The backup console will show a display indicating the backup status and show name.*
-

In backup mode the backup console screen displays the current connection and sync status including current show name.

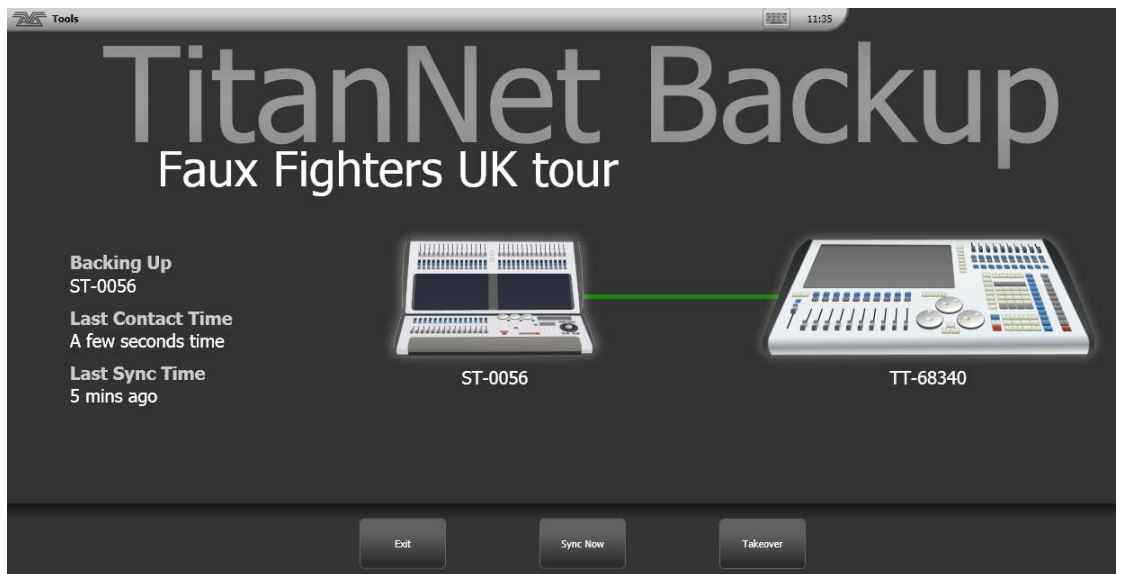

A green line between consoles represents a good connection. If a red line is shown there is a problem with the network connection. A blue line will appear during sync operations.

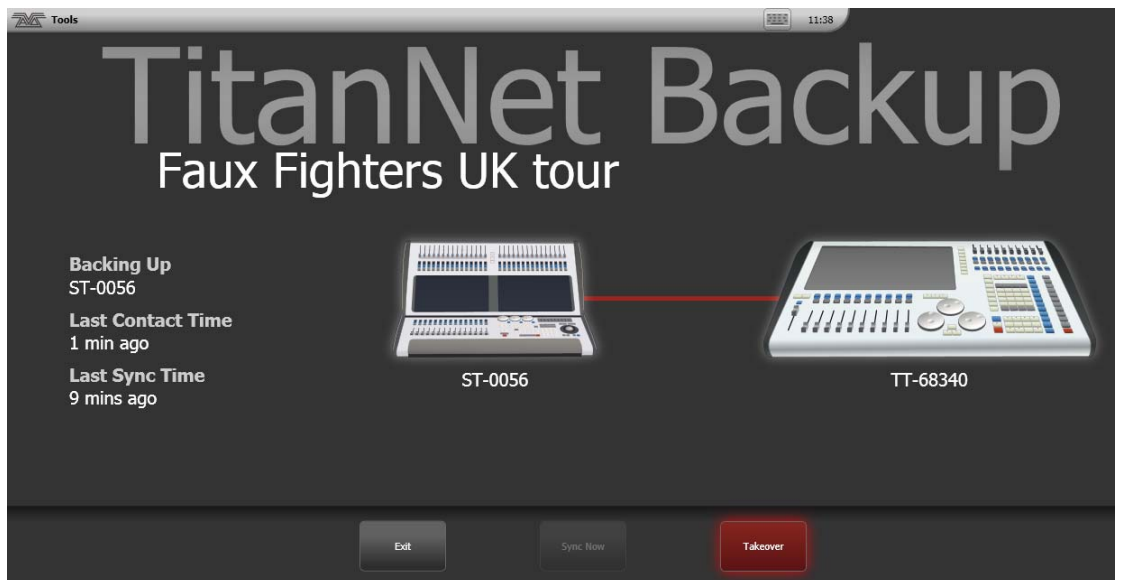

- Shows will automatically sync whenever a show is saved on the main console (including autosave). You can also choose to sync at any time by selecting [Sync Now].
- Pressing [Exit] will abort backup.
- [Takeover] will enable control on the backup console and disable DMX output on the main console. A prompt will appear on the main console to warn that DMX has been disabled. On touch consoles touching on this prompt will open the 'Exit Safe Mode' menu with a softkey option to re-enable output. On the Pearl Expert you can re-enable DMX output via the shift (Avo) menu.

11. Remote control

With the addition of an external Wireless Access Point, the console can be remote controlled using Wi-Fi from an Android or iOS mobile device such as a smartphone or tablet. This can be invaluable when rigging, testing and focusing. You can also run and store playbacks and palettes from the remote.

You can connect multiple remotes to the console and the console itself remains functional while the remote is connected.



The remote function operates using the Avolites Remote app on the mobile device. This can be downloaded from the Google Play store or Apple App Store.

11.1 Setting up the remote

All you need to do is make sure that the console is on the same network as your mobile device. The app will automatically detect all the consoles on the network.



Ensure that Wifi security is enabled on the network you are using, as anyone who can connect to the wifi will be able to control the console. You don't want someone in the audience taking over the show.

- You may experience problems with the remote if you have an internet router on the network, as this may route show traffic to

the internet rather than between the remote and the console. If the remote does not work properly, disconnect your router from the network.

11.1.1 Using an existing network

If you are connecting to an existing network, DHCP will probably be enabled which will automatically set suitable IP addresses on the console and mobile device. All you should need to do is to plug the console's Ethernet connection into the network.

If the console is set to have a fixed IP address you will need to manually set a suitable IP address for the network – consult the person who manages the network.

11.1.2 Network setup using a dedicated access point

This is a basic setup assuming that the console is connected directly to an access point. For information on setting up your Wireless Access Point please refer to the documentation provided with it.

- We advise using a proper wireless access point rather than a wireless router (ADSL router). Although routers are cheaper, the WiFi connection through to the Ethernet is often slower.

You need to set up the network settings on the Wireless Access Point, the mobile device and the console so that they can communicate with each other. In this example we use an Android smartphone but other devices are similar.

-
- 1> *In the access point's admin screen, give the access point an IP address such as 10.0.0.1, make sure wireless is switched on and enable the DHCP server. Take note of the name of the wireless network (SSID).*
 - 2> *Connect an Ethernet cable from the back of the console to the access point.*
 - 3> *Set the IP address of the console: Switch to System, select [Network Settings], press [Local Area Connection], then press [Set IP 10.*.*.*].*
 - 4> *On the mobile device, go to WiFi settings or Network Settings and ensure Wi-Fi is set to on.*
 - 5> *Select the wireless network from the list, the name you took note of earlier. The mobile device should automatically get an IP address from the access point.*
 - 6> *Run the Titan Remote app. You should see the console listed.*
-

11.2 Operating the remote

To connect to the console, open the Titan Remote app and a list of available consoles will be shown - hopefully if you have done the network setup correctly, you will see your console listed.

There is also a local emulator which can be used to test or demonstrate the remote when no real console is connected.

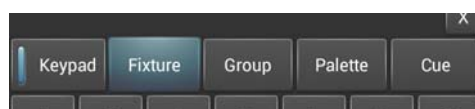

Choose what you want to control using the row of buttons across the middle of the app. The Keypad button enables or disables the numeric

pad (the keypad overlays all the other screens, so you will need to turn it off to see the others).

11.2.1 Keypad

The keypad screen lets you do most common tasks in the way a programmer's remote normally works. You can turn on/Locate fixtures and dimmers either singly or together.



The User Number of the fixture or dimmer is used for control. For example to turn on dimmer 3 at 50% you would press:

3@5

To turn on dimmers 1-10 at 80% you would press:

1 Thro 10 @ 8

For 100% you just press @ twice, for example

1 Thro 10 @ @

To locate one or more fixtures, press Locate instead of the @ button. You can select multiple ranges of dimmers or fixtures using the And button, for example *1 Thro 10 And 20 Thro 30 @ 6*.

11.2.2 Controlling fixtures

The fixture screen allows you to select fixtures exactly as you would on the console.



You can then use the Palette screens to control the fixtures, or press the IPCGBES buttons to directly control functions of the fixtures using wheels.

You can scroll the fixture screen up and down by dragging the window. To view the fixture pages, drag the Pages bar to the right.

Press the All button to select all fixtures. Hold down the All button to step through various selection patterns (odd, even etc).

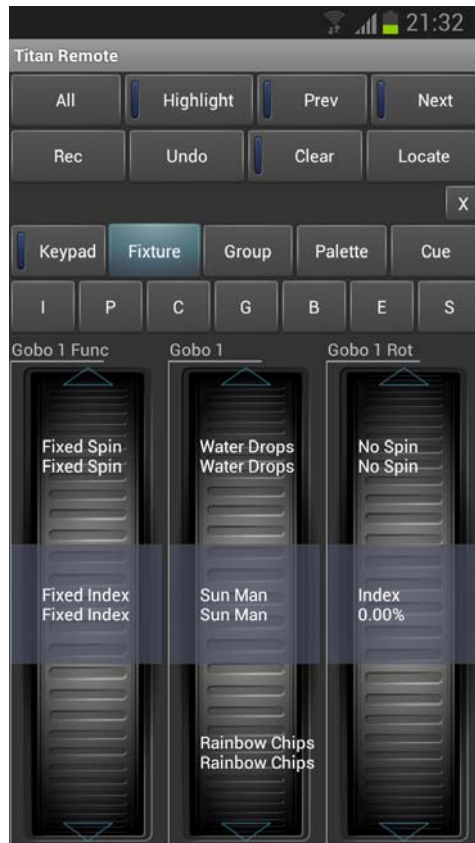

The wheels show function values (such as colours or gobo names). To go to the next function, just touch the arrows at the top or bottom of the wheel. To manually scroll the value, spin the wheel with your fingers. If there are more than three functions, touch the IPCGBES button again to change to the other functions.

Press the Clear button to clear the selection and all changes in the programmer. Hold down the clear button to clear all programmers (for example if someone has been doing something on the console at the same time, this will clear the console's programmer too).

You can also play back cues using the Cue screen. Hold down a playback button to kill or release an active playback.



If you update the legends of palettes or cues on the console while the remote is running, the legends on the remote will not be updated. Exit and restart the remote app to show changes on the console.

11.2.3 Recording groups and palettes

You can record groups and palettes using the Rec button on the remote, then click a workspace button as normal. You can also hold down an empty button to quick record a group or palette.

If you hold down a used palette button, the current programmer will be quick merged into the existing palette.

You cannot record cues on the remote.

12. User Settings and other options

The console has a large number of options to help you set it up just the way you like it. Commonly used options can be set from the User Settings menu which is available on a softkey when you hold down the Avo button.

In this chapter there is also information on how to upgrade the application software.

12.1 Configuring the Workspace

The main area of the screen and the external monitor can each show up to 4 workspace windows. Workspaces can be saved to a touch button and called back immediately.

Some windows have associated commands, when the window is active these are shown in the context

12.1.1 Opening workspace windows

You select which workspace windows you want to see using the [Open Workspace Window] menu command on the root menu or the View menu, or by pressing the appropriate Window Selection button just to the right of the touch screen.

12.1.2 Selecting and positioning workspace windows

To change the position of a workspace window you first make it active by touching its header bar.

You can change the positions and sizes of the active window by using the Window Control buttons above the numeric keypad or touch the 'i' button on the top bar of the window. The min/max button swaps the active window between full screen and quarter size. The size/position button moves the active window around the possible positions. There are also softkeys on the Window Options menu for the same functions.

Some possible window sizes/positions are shown below.



Quarter size



Double wide



Double height



Maximised

You can move the active window between screens by pressing View then [Window Options] then [Move Screen], or hold Avo and the Size & Position button.

You can close the active window using the Close button. You can close all windows by pressing Avo+Close, or use the [Close All] softkey.

12.1.3 Saving workspaces

You can save different workspace setups to the Workspaces touch buttons (to the left of the menu) by pressing View then [Record Workspace], then touching one of the Workspaces buttons. This button will then reconfigure the entire workspace with a single touch.

Workspaces are saved with the show.

As an example of setting up a workspace, suppose while programming you wanted to be able to access fixtures, position palettes, fixture attributes and shapes:

- 1> Press Exit to get to the root menu then the [Open Workspace Window] menu softkey.
- 2> Find the [Fixtures] window in the list and press it.
- 3> If the window is not in the top left quarter, press the Size & Position button (above the numeric keys) until the window occupies the top left quarter.
- 4> Press [Open Workspace Window] again and select the [Positions] window. Press the Size & Position button to position it in the desired location.
- 5> Repeat to activate the [Attribute Control] and [Shapes] windows.
- 6> Press View (to the right of the numeric keys) then [Record Workspace], or hold Avo and press View. Type in a name for the workspace. Then touch the Workspace button where you want to store this workspace layout. Or, you can use Quick Record – just touch an empty workspace button and it will turn red with a +. Type a name for the workspace and touch again to store it.

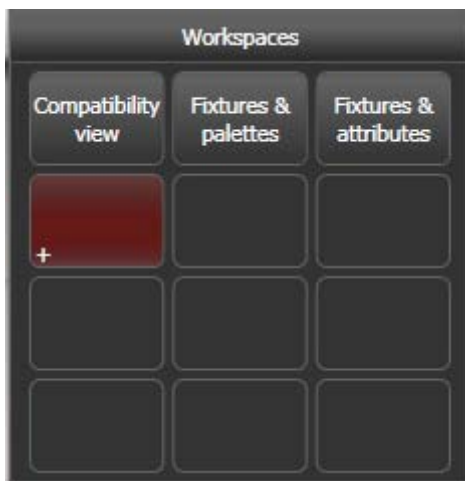

- [Record Visible/All Windows] lets you set whether the workspace will contain only the windows which are currently visible, or will also include any windows which are hidden underneath other windows.
- [Remove/Leave other windows on recall] sets whether all other windows will be closed when this workspace is recalled.
- To delete a workspace button, press View, Delete, then the workspace button to be deleted.

12.1.4 Compatibility windows for Pearl Expert shows

The “Fixtures and Playbacks” and “Groups and Palettes” windows allow you to access the preset fader handles in shows which have been programmed on the Pearl Expert.

When either of these windows is opened, there is a context button option to [Move to workspace]. This will move the handles from the compatibility window to the appropriate workspace window. You need to do this twice, once with the “Fixtures and playbacks” window selected, and once with the “Palettes and groups” window selected.

12.1.5 Configuring an external monitor

For extra workspace you can connect an external monitor to the VGA port on the console.

The external monitor is disabled by default and will show a 'disabled' message. To enable, switch to System mode and select [Display Setup] then press [External Display Disconnected]. The option will change to [External Display Connected] and the display will be enabled.

For best performance of the console, disable monitor outputs you aren't using.

If you need to change the monitor resolution or settings, click 'Tools' at the very top of the touch screen and select 'Control Panel', then 'External Monitor', then select the option to match the resolution of your monitor.



Troubleshooting

If you cannot see anything on any screen, there are some keyboard shortcuts that should in most cases reset all the screens back to their correct settings. You will need to connect an external keyboard (standard PC type) to activate these.

Ctrl+Shift+Alt+Esc reset to factory default settings (1024x768 for external monitor)

Ctrl+Shift+Alt+F1 (600x800 for external monitor)

Ctrl+Shift+Alt+F2 (1024x768 for external monitor)

Ctrl+Shift+Alt+F3 (1280x1024 for external monitor)

Ctrl+Shift+Alt+F4 (1600x1200 for external monitor)

All of the above will reset the touch screen to the required resolution. The first shortcut is the preferred choice, however none of these should be used unless it's necessary (using the menu or Display Setting where possible). Once any of these keyboard shortcuts has been used, power off and restart the console to complete the changes.

If the console software is running, you may have to press Esc to unlock the keyboard before the shortcuts will work.

If none of the above works, the second solution is reinstall the graphics drivers.

1. Press F8 on start up and enable VGA MODE (use an external keyboard, or the Zoom/Focus/Iris attribute button is also mapped to F8 – see section 1.1.1).
2. In Tools, Folder Options, View - enable Show hidden files and folders.
3. In Control panel, System, Hardware, Device Manager, Display Adapters - right click on 945GME and update driver.
4. Select the driver to install as C:\Windows\Inf\iegd.inf.

12.2 Key Profiles

The console allows you to reconfigure how the front panel buttons work to suit your method of working. You can save your settings as a Key Profile. Different profiles can be selected for different users or to enhance the operation of the console for a particular use.

There are standard Key Profiles for Run mode, Takeover Run mode and Program mode. These standard profiles cannot be edited, so you always know how they will behave. You can create your own editable profiles using one of the standard profiles as a starting point.

The current settings of the playback buttons are shown on the screen related to each playback fader.



12.2.1 Creating and editing key profiles

To create or edit a profile, switch to System mode then select [Key Profiles]. You can then use the Manage Profiles menu to View, Edit, Add, Delete or Rename profiles.

When Adding a new profile, you can select an existing profile to copy settings from.

You can also edit Key Profiles from Program mode by holding Avo, then selecting [Edit Current Key Profile]. If the current key profile is one of the non-editable system ones, you are prompted to add a new profile or select an existing editable profile.

The current settings for the [blue], [grey] and (where available), [touch] buttons are shown on the left side of the screen.



The groups of keys you can set are as follows. The blue or grey fixture/palette buttons only exist on the Pearl Expert, on other consoles these settings will not do anything.

Fixtures: the blue, grey or touch key can be allocated to Disabled, Select, Flash, Swop, Latch. The “Latch” function is equivalent to putting the fader to full for that fixture and touching again returns the fader to 0.

Palettes: the palette (grey) key can be allocated to Disabled or Select Palette. You can select if the palette function takes precedence over the flash function (if a handle has both palette and flash functions) or vice versa.

Groups: the group (grey) key can be allocated to Disabled, Select Group. You can select if the group function takes precedence over the flash function (if a handle has both group and flash functions) or vice versa.

Cues: the blue or grey key can be allocated to Disabled, Flash, Swop, Latch, Preload.

Chases: the blue or grey key can be allocated to Disabled, Flash, Swop, Latch, Go, Stop, Preload, Connect, Tap Tempo.

Cue Lists: the blue or grey key can be allocated to Disabled, Flash, Swop, Go, Go Back, Stop, Preload, Connect, Next Cue +, Next Cue -, Review Live Cue, Cut Next Cue To Live, Snap Back, Release.

Macros: can be set to Select or Prefer Macro (the Macro function will take precedence over other functions stored on the button).

Quick Record: allows you to disable the quick record function.

12.2.2 Selecting a Key Profile

A Key Profile is selected in Run mode by pressing softkey B and selecting the desired profile from the list. In Program mode, hold the Avo Shift button and press [Select Key Profile].

12.2.3 Individual Key profiles for playbacks

Each playback can have an individual Key Profile allocated to it. This allows you to customise the panel button functions differently for each playback. The Key Profile for the playback is selected using the [Key Profile] option on the Playback Options menu (softkey B on the main program menu). If the playback Key Profile is set to "None", the default global profile is used.

12.3 The System menu

The System menu is accessed by switching the mode switch to System. The options in this menu are separated from the other options on the console because you would normally only change them occasionally, or because they can have serious effects on the way the console works and you wouldn't want to change them accidentally.



When the console is in System mode, playback control, preset controls and programming buttons are all disabled.

12.3.1 TitanNet Security

This option sets how the console communicates with other Titan devices as a backup console. See section 10.6 for information about backup.

12.3.2 Network Settings

This option sets up networking (Ethernet) parameters for the console. See section 14 for details.

12.3.3 User Settings

The User Settings menu may also be accessed from Program mode: hold down the Avo Shift button and press [User Settings].

There are several pages of options and the bottom two softkeys go through the different pages.

- [Grand Master...] sets whether the Grand Master fader is enabled or disabled. This can be handy if it gets broken or if you wish to disable it to avoid confusing inexperienced operators. The default setting is 'Disabled'.
- [Prompt for Merge or Replace...] sets the console action when you try to save to a handle or playback which is already used. The options are [Prompt for Merge or Replace] - the console will always prompt, [Always Merge] - the console will never prompt or [Palettes Always Merge] - the console will prompt unless you are saving a palette.
- [Warn before parking fixtures ...] sets the console action when you patch a fixture which overwrites the DMX channels of another fixture. This causes the overwritten fixture to be

“parked” The options are [Always] (console will warn you) and [Never] (console will park the fixture without warning you).

- [Tempo Units...] sets the units for displaying tempo. The options are [Beats per Minute] or [Seconds].
- [Connected View ... Chase Speed] sets the console action when you change the speed of a connected chase. [Connected View Sets Temporary Chase Speed] means that the console will not save the modified speed, and the next time the chase is fired it will go back to its programmed speed. [Connected View Sets Chase Speed] means that the console will modify the saved speed of the chase.
- [Auto Connect...] sets whether Chases and Cue Lists will auto-connect to the wheels when the playback is fired. The options are [Off], [Chases], [Lists] and [Chases and Lists].
- [Channel Levels...] sets how you enter channel levels when using numeric entry of levels. If set to [Channel Levels Set In Tens], you enter one digit for the channel level (e.g. 5 = 50%). If set to [Channel Levels Set in Units] you enter two digits, i.e. 50 = 50%.
- [Preload Time] sets a fade time for the Preload function, normally 2 seconds. This value would normally be set for quiet fixture movement.
- [Quick Palettes] enables or disables the Quick Palette function. See section 5.2.3.
- [Press and Hold Fan] changes the Fan function so that it only works while the Fan button is held. This avoids the common user error of leaving Fan turned on accidentally.
- [Key Profiles] accesses the Key Profiles menu which can also be found on the System menu. The option is here so that you can access it using the Avo Shift button. See section 12.2.
- [LED Levels] sets the behaviour of the LEDs in the Select buttons. This option only works on the Pearl Expert.
- [Timecode] This option lets you select the settings for glitch detection, tolerance and timeout when using MIDI timecode.
- [Wheel sensitivity] The sensitivity of the encoder wheels, and the pan/tilt threshold settings can be adjusted using this option. Wheel sensitivity is adjusted using Wheel A and the current level is shown on the display.
- [Add New Palette Channels to Playbacks] sets whether new channels added into palettes will be added to playbacks using those palettes.
- [Auto Groups] sets whether the console will automatically create new groups for fixtures when you patch.
- [Handle Buttons] lets you set the size of the touch buttons to [Small], [Normal], [Large] or [Super Size].
- [Text Size] allows you to set the size of the text used in touch buttons.

12.3.4 Key Profiles

Allows you to modify the functions of some buttons. See section 12.2.

12.3.5 Wipe

The Wipe menu erases the current show. This is the same as the [New Show] option on the Disk menu, but is provided here for experienced Avolites users who are used to it being on the System menu.

The [Wipe Visualiser Patch] option will erase all fixtures from the visualiser without affecting the current show.

12.3.6 DMX settings

Allows you to configure how the console outputs DMX. This option is described in detail in the next section 12.4.

12.3.7 Triggers

Sets up the console for external triggering such as MIDI or DMX-in. This option is described in detail in section 10.5 on page 177.

12.3.8 Display Setup

This option gives you a menu for enabling and disabling external monitor(s). If you don't have a monitor connected, set this option to "Disabled" to improve the performance of the console.

12.3.9 Assign mastering

This option allows you to assign any playback fader to be a master fader. Various different types of master fader may be assigned. See section 10.1.5 on page 171 for more information.

12.4 DMX output mapping

There are various ways to connect fixtures to the console. As well as the XLR sockets on the console, you can connect fixtures using Ethernet and wireless links.

The console itself can output up to 12 universes of DMX. "Pro" versions of consoles can output 16 universes. Titan One outputs one single universe.

If you need to output more universes, it is recommended to network the console to one or more Avolites TitanNet processing nodes. This off-loads the DMX processing, allowing the console to control up to 64 universes of DMX in total.

- The software will allow you to configure more than 12 universes from a single console but performance of the console will be degraded. A warning will be shown in the processing load section of the TitanNet overview.

12.4.1 Configuring DMX outputs

Switch the console to System mode and select [DMX Settings] on the second page of options.

The screen will initially show the node tab relating to the console itself. It shows a list of available DMX *nodes* (places where you can send the DMX to) on the left, and a list of the 12 available DMX *lines* (outputs generated by the console) on the right. Each DMX line can send data to one or more nodes. If you assign more than one node to a line, those nodes receive duplicated data.

On the right hand side, under each DMX Line there is a list of which nodes are linked to that line. The default setting is for DMX Lines 1-4 to be linked to DMX Nodes Output A-D, the four XLR sockets on the console.

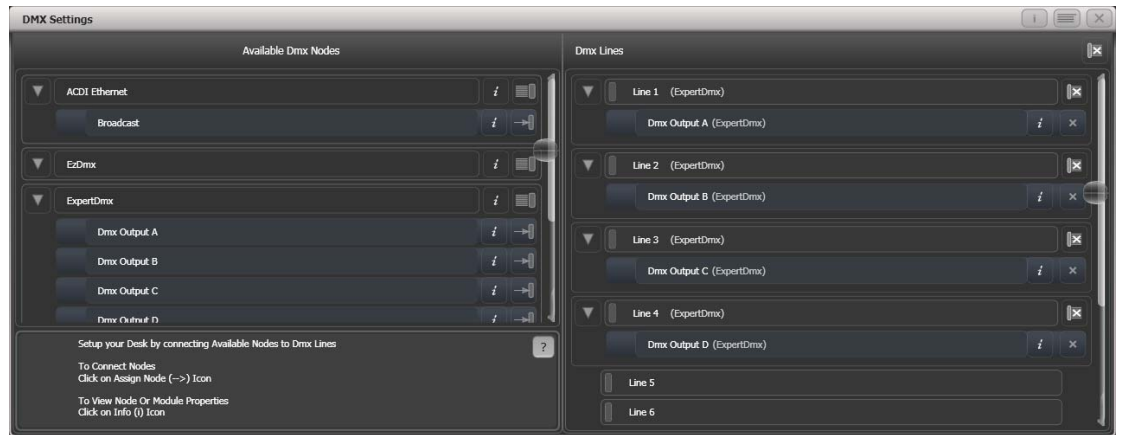

You can individually assign Nodes to Lines using the arrow button, or assign all Nodes of the same type using the group assign button. For example, to assign each XLR output socket on the back of the console to a DMX line, you would click on the Group Assign button of the ExpertDMX nodes.



To assign a node to a line, click on the arrow on the node (the node will be highlighted), then click the line you want to assign to it.

To delete a node from the DMX lines, click on the X button. To delete all nodes from a line, click on the Group delete button

You can show information about the DMX nodes, or the DMX lines, by clicking the i button. For Ethernet/network type nodes, this allows you to set detailed properties such as IP address ranges and net masks.

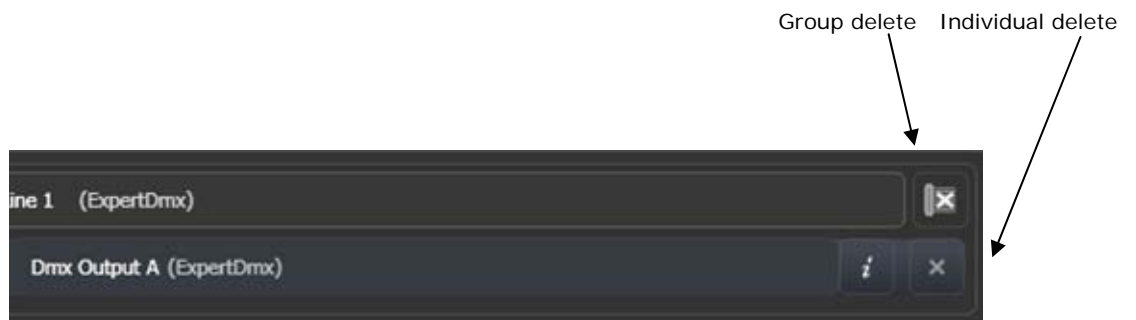

If you have further networked DMX processing nodes connected, these can be individually configured using the tabs across the top of the screen.

12.4.2 TitanNet Overview

If you select the TitanNet Overview tab at the top of the screen, you can see all the DMX nodes which are connected and which output lines they are allocated to.



The left side of the screen shows the 64 possible DMX output lines on the console. To the right of this are the processing nodes which are connected, the top one being the console itself. Each node shows how the lines are allocated to the physical outputs on the device. Clicking this area will open the detail tab for the node.

Clicking any one of the nodes will show detailed information about that node on the right, including the IP address, number of available processing slots, number of lines assigned, status of the connection with the node, and the processing load of the device. If more lines are assigned than the maximum number of slots, a warning will be displayed.

If a show is loaded that had fixtures and lines assigned to processing nodes which are no longer found on the TitanNet network, a screen will appear listing nodes in use and available nodes, giving you the option to reassign the lines.

12.5 Curves

The console provides a variety of curves which set how the console tracks fades in playbacks; either the same speed all the way (linear), or starting and ending gently but faster in the middle, and various other options. Curves are set using the [Playback Options] menu (see section 7.6.3 on page 140).

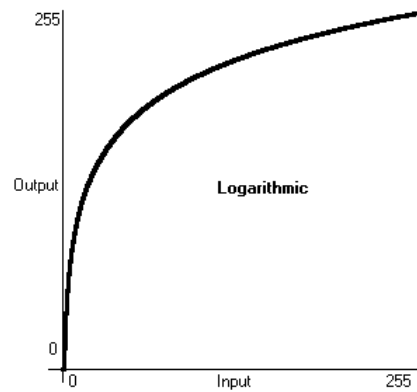
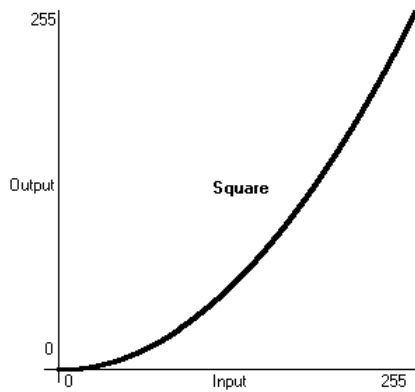
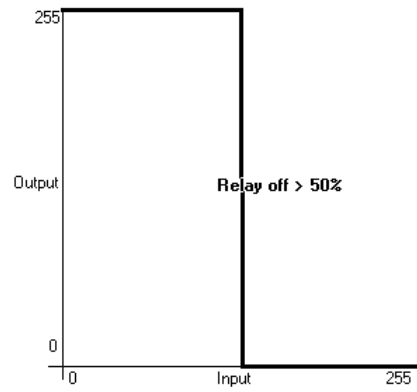
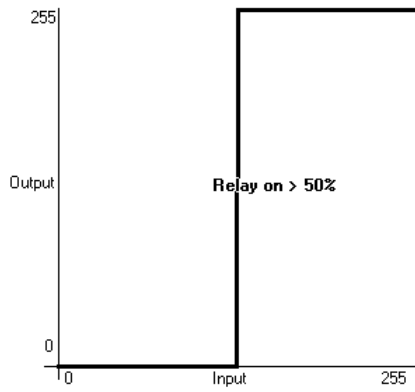
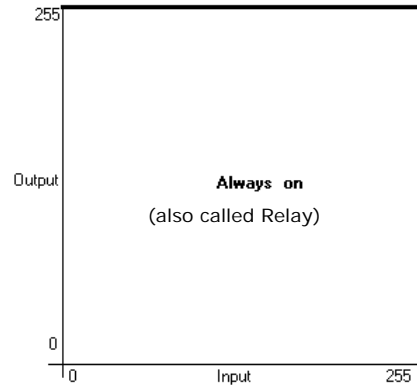
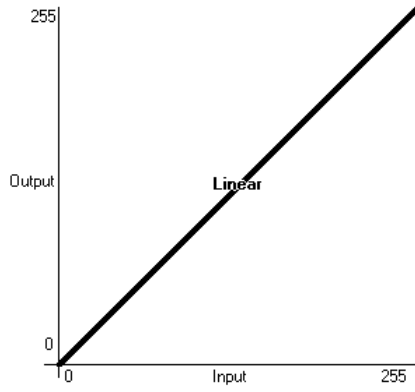

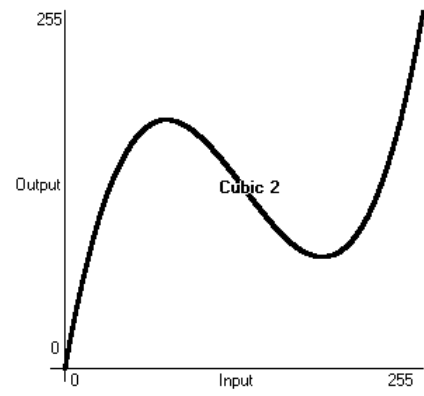
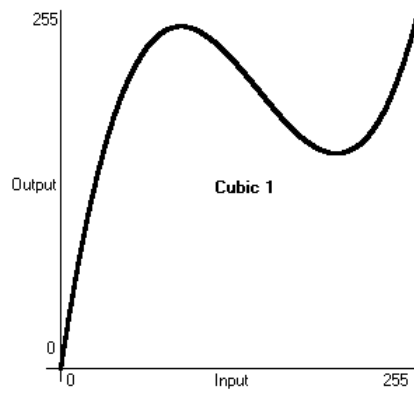
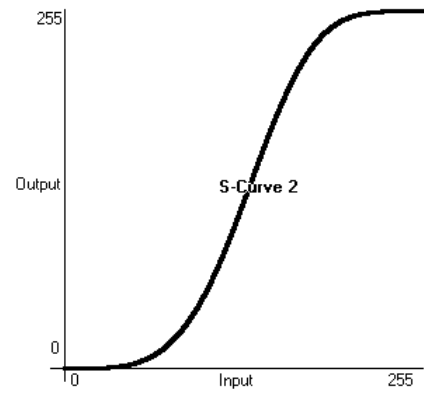
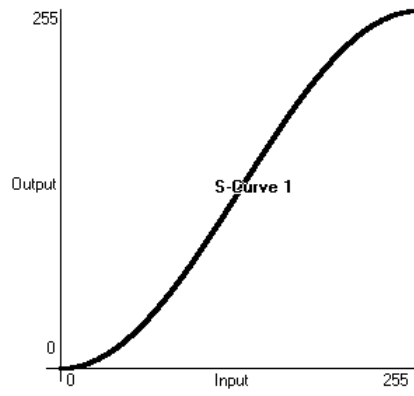
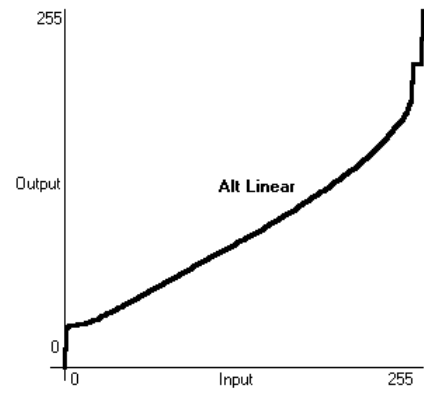
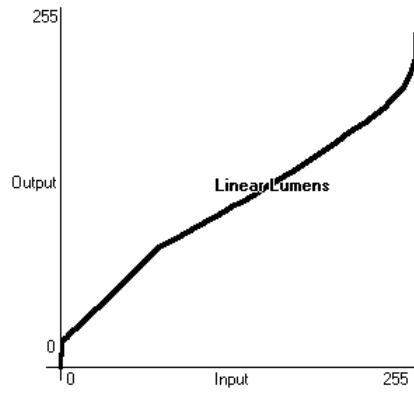

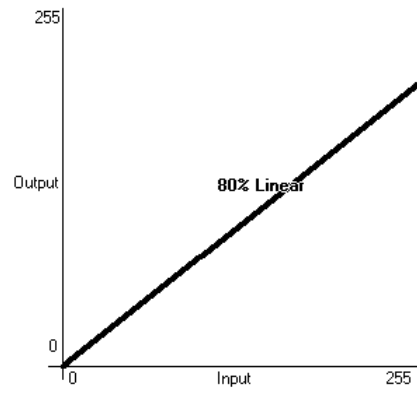
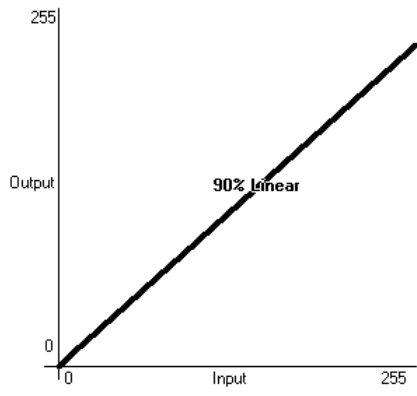
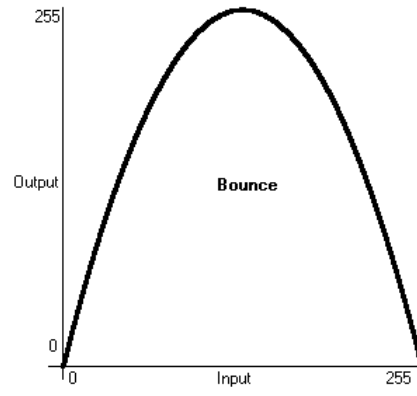
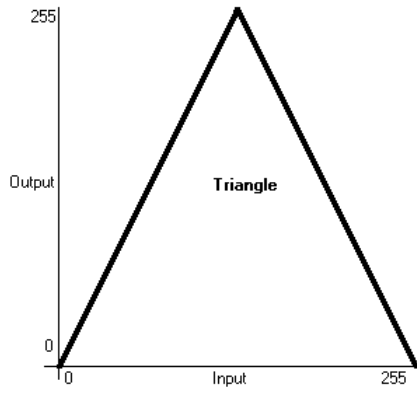

12.6 Upgrading the software

The console operating software is under constant revision by the Avolites team. You can always download the latest version of the software from the Avolites website:

<http://www.avolitesdownload.com>.

Software upgrades for the Tiger Touch must be installed from a USB pen drive.

Having downloaded a new version of software, copy it to the media and install it on the console like this:

-
- 1> *Copy the installer file to a USB pen drive and plug this into the Tiger Touch.*
 - 2> *On the screen tools menu, stop the console software using the Shutdown Software button at the bottom of the list.*

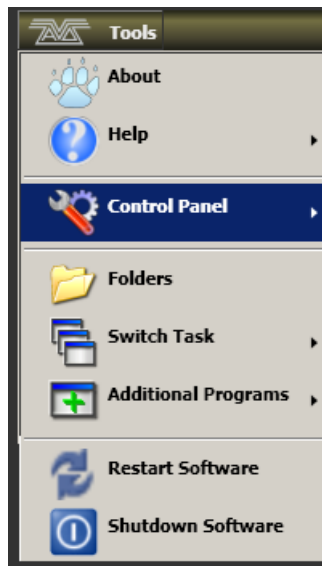

- 3> *Open the tools menu again, touch the Folders icon and open the drive where the upgrade file is found.*
 - 4> *Run the installer.*
 - 5> *When the installation has completed, shut down the console and restart it. This will allow any operating system updates to install.*
-

12.7 Recovering/reinstalling the system

The console runs on an embedded PC system, and like all computers, there is a possibility of system failure. If it becomes necessary to reinstall the operating system, this is how you do it.

To reinstall the operating system you need a Tiger Touch USB recovery stick, which is provided with the console or obtainable from Avolites.



Using the recovery stick will delete all settings and files from the console including show files and user personalities. Any files should be saved to a separate memory stick before continuing.

12.7.1 Booting from USB recovery stick

- 1> *Ensure memory stick is plugged in.*
 - 2> *Start up console pressing Delete button to enter the BIOS.*
 - 3> *When prompted, type in the password '68340', to enter the BIOS.*
 - 4> *Once in the BIOS, press down arrow once then Enter button to open the second menu.*
 - 5> *Then again, press down arrow once then Enter button to open the second menu.*
 - 6> *Press the blue Copy/Move/Link button repeatedly until 'USB-HDD0' is in position 1.*
 - 7> *Press the Speed button (on the Attribute Bank buttons) then Enter, to save changes.*
 - 8> *When the console restarts it will boot automatically into the memory stick.*
-

12.7.2 Installation Instructions

- 1> *Wait while the memory stick boots up, this can take up to 3 minutes.*
 - 2> *Once the memory stick has booted, the touch screen will display 'Welcome to Tiger Touch', touch Next to continue.*
 - 3> *Please read to the bottom of the licence agreement then touch Agree to accept.*
 - 4> *On the next screen type in the serial number of the Tiger Touch (using the numeric keypad) - this is the number following the 'TT-' written on the back of the console.*
 - 5> *Touching Install will then format the hard drive and copy the setup files to it.*
 - 6> *Once complete unplug the memory stick and touch the Restart button.*
-

After restarting the console will then install all the software and drivers required to run. This takes approximately 30 minutes to complete during which the console will reboot a number of times. Please do not switch off the console during this process.

12.7.3 After Installation

Once complete the console will boot into the operating system and you will be required to enter the activation code to unlock Titan. A dialog box should be shown on screen asking for the activation code which can be typed in using the on screen keyboard or the numeric keypad. If the dialog box is not visible it may be hidden by another window, in which case use the switch task menu and select 'Tiger Touch Titan'. The activation code can be found on the front of the

console. Once the activation code has been entered successfully, please restart the console.

12.7.4 Front panel button mapping for BIOS

Because you won't normally have a keyboard plugged into the Tiger Touch, some of the front panel buttons have been allocated to keypresses so that you can control the BIOS if necessary.

Attribute Bank buttons 1-12 = F1-12 (e.g. Dimmer is F1, Speed is F10)

Numeric keypad 0-9 as normal

Exit: Esc

Enter: Return

Up, Down, Left, Right arrows: cursor keys as you would expect.

The top 6 blue function buttons are used as follows:

Record Cue:	Y
Record Chase or List:	N
Record Macro:	+
Copy/Move/Link:	-
Record Palette:	BACKSPACE
Delete:	DEL

13. Working with Fixture Personalities

For each type of fixture, the console has a “personality” file which tells it how to control the fixture, which channel is the dimmer (HTP) channel, and a large amount of other fixture-specific information. When you patch each fixture, you tell the console which personality to use for it.

The console holds a personality library containing all commonly used fixtures, but new fixtures are appearing all the time and Avolites are constantly updating the library.

We recommend that you should update the library from time to time to take advantage of new fixtures, as well as receiving bug fixes for personalities and new features which may be added such as subfixtures.

13.1.1 Downloading fixture personalities from Avolites

The Avolites website lists all fixtures for which personalities have been created. You should look here first if the console does not contain a personality for your fixture. The address is

<http://www.avolitesdownload.com/personalities/>

Fixture Name	Desk	File Name	Name On Desk	Last Update	DMX	Disk	Cache	Details	Report Bug
Mac2000 Profile	Pearl Expert Titan	Martin_MAC 2000 Profile.D4	Mac 2000P	25/08/2009					

All available fixture personalities are listed down the left side of the screen. You can use the boxes on the top left to filter the list to show fixtures from specific manufacturers, or fixtures available for a certain console, or to search for a specific fixture name.



Ensure you have selected the correct console type in the “Desk” field. All Titan consoles use the same personalities, but the installer program is customised to the different consoles.

Click on the fixture name to open the details in the right hand window. This shows all the personalities available for that fixture type (if you have entered the console type on the top left, only personalities for that console will be displayed).

If the personality is included in the standard library (cache) then the column will be ticked.

If there is a personality listed for your fixture, download it by clicking on the Disk icon. This will download a copy of the complete personality library.

13.1.2 Updating the personality library on the console

Download the current Titan personality library by clicking on the disk icon in the Cache column for any fixture. Alternatively you can get this file by clicking on the Download link at the top of the screen, then clicking on the link for your console.



Updating will overwrite any custom personalities you have stored in the library. To avoid this, store your custom personalities in the user personalities folder (see next section for details).

To update use the following procedure:

-
- 1> Copy the downloaded file *TigerTouchFixtureLibrary.exe* onto a USB pen drive and plug in to the console.
 - 2> Click the 'Tools' menu on the toolbar, then the folder icon on the menu.
 - 3> Locate the downloaded file on the USB drive and double click on it to run it. Click 'Ok' on the warning box.
 - 4> Shut down and then restart the console (using the Restart Software button on the screen Tools menu is OK).
-

- The console caches the FixtureLibrary folder into memory when the Patch option is first used. You therefore need to restart the console to ensure new fixture personalities are loaded (restarting the console application is sufficient).
- Once a fixture is patched, its personality is embedded in the show file. Any changes to the fixture library will not affect fixtures patched in the show. You can use the [Update Personality] option in the patch menu to update patched fixtures if you need to.

13.1.3 User/custom personalities

Using the Personality Builder application installed with the console software, you can create your own personality if you wish to modify the behaviour of a standard personality or you have a fixture the console has never heard of and need to get it working quickly.

You can incorporate your custom personality into the standard fixture library on the console, however there is a danger that it will be overwritten when you next update the Fixture Library from Avolites.

To avoid this the console provides a special folder for user-provided personalities located at

D:\Personalities

If you are using the Titan Simulator, the folder is located at

\My Documents\Titan\Personalities

When patching fixtures, this folder is searched first before the library. If a suitable Fixture Personality is found, the console will use it rather than using the library. This folder is not affected when the personality library is updated.

13.1.4 Requesting a new fixture personality

If a personality does not exist for your fixture, Avolites will create one for you. Click on the "Request" link on the above web page to submit your request. A list of current requests is shown, so you can check if someone else is asking for the same thing.

Your new personality will be incorporated into the library – to install the new personality, download and install the latest personality library as described above.

13.1.5 Reporting a personality bug to Avolites

If you find a problem with a fixture personality, Avolites would like to know about it so it can be fixed. Search for the personality on the website then click on the "Report Bug" icon on the right of the screen. If you click on the "Bug Reports" tab at the top of the window, a list is shown of currently outstanding problems, so you can check if someone else has already reported the problem.

13.1.6 In an emergency

The console contains a selection of "Generic" fixtures which you can use in an emergency if you need to operate a fixture with no personality. When patching, go through the manufacturer list until you find [Generic]. In this section (among other fixtures) are the following:

Multi-DMX: Has up to 10 DMX channels, all channels are LTP. You can select from 1-10 channels on the Mode screen. Press Attribute Bank and use the softkeys to select channels.

Generic RGB: Allows you to control an RGB fixture such as LED colour changers. This offers 5 modes:

1=Dim 2=R 3=G 4=B

VDim 1=R 2=G 3=B

1=R 2=G 3=B 4=Dim

VDim + 4xRGB

4xRGB.

VDim is a virtual overall dimmer channel for fixtures without a DMX dimmer control. When you use the Dimmer attribute the console will adjust the RGB levels accordingly.

14. Networking the console

There are a number of ways for the console to communicate with lighting fixtures beyond the traditional DMX sockets, and these are described in this chapter. The console also supports communicating with a number of different simulators/visualisers over various communication methods.

You can also connect networked processing nodes, which allow you to control up to 64 universes of DMX (the console itself can produce up to 12 universes), and you can connect a second console to act as a tracking backup.

At the end of the chapter is a section which aims to cover the basics of IP addressing, which is essential for various features on the console such as Art-Net.



Lighting networks need to transfer of large amounts of data. For best reliability you should use network wiring which is dedicated to the lighting system and physically isolated from other networks, and uses simple hubs rather than intelligent switches.

Connecting to an existing network with other network traffic is possible but can lead to problems both with the lighting equipment and with other IT equipment on the network. Intelligent Ethernet switches may drop or block lighting data. If you need to do this please read about the IP addresses you should use, in section 14.5.5.

14.1 Controlling fixtures over a network

Before the console can talk to another device over the network, it has to be given a unique network address. This is called its "IP address".

14.1.1 Setting IP address

We recommend that you use the console's automatic IP setting function. However, if you need to you can also set the IP address using Windows Control Panel as shown on page 215.

-
- 1> Switch to System mode and press [Network Settings]
 - 2> Press [Local Area Connection].
 - 3> Press [Subnet Mask] and set to 255.255.255.0
 - 4> Press [Set IP 2. *. *. *. *]
 - 5> Press [Save settings]
 - 6> Turn the switch back to Program.
-

- Some equipment may operate on IP addresses 10.*.*.* (softkey D) – see later in this chapter for details.
- If you need a non-standard IP address range you can use softkey A.

14.1.2 Setting up DMX outputs

The console has 64 DMX output lines (up to 12 on the console itself, with further lines available using networked DMX processing nodes). The Titan One dongle is limited to one DMX line. The lines may be routed to physical DMX sockets or to network nodes.

Section 12.4.1 on page 196 tells you how to set up this routing, and an example is given in section 14.1.4 on the next page.

14.1.3 A simple Art-Net system

There are various different systems for sending lighting control information over a network. One of the most widely supported is Art-Net.

Art-Net is not specific to one range of products, and is recognised and implemented by a growing number of manufacturers. Many products (such as Dimmers and Moving lights) can accept the Art-Net signal directly, so there is no need to convert the signal to DMX. Most people will, however, need to output DMX to their equipment and this can be done using an Art-Net to DMX converter.

In the following diagram, an Art-Net compliant Console (such as a Titan console) is connected via a network hub to an Art-Net compatible dimmer and 2 DMX conversion boxes.

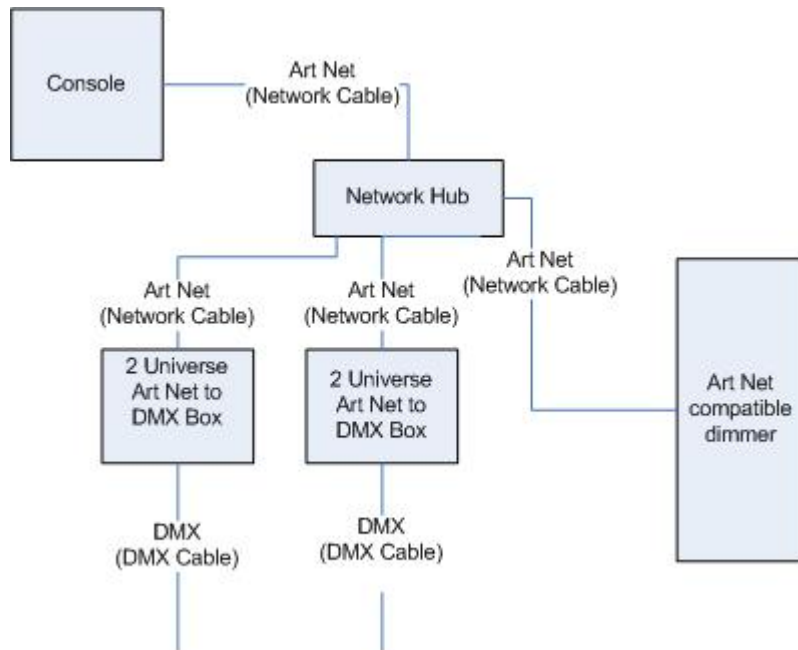

Once the system is connected together, the different outputs (or Nodes) can be configured.

- The dimmer is given the start address of 200
- The 1st DMX box is set to universe 1 and universe 2
- The 2nd DMX box is also set to universe 1 and universe 2

The console is then used to set the DMX lines to the Art-Net nodes.

It is important to remember:

- Each Art-Net to DMX box (or compatible Dimmer, or compatible moving light) is a device,

- Each device may have one or more nodes (i.e. the Art-Net to DMX box has 2 nodes, these are the 2 DMX outputs; the dimmer itself is a node),
- Each node can be set to a Universe (1-256). This universe is equivalent to a 512 channel DMX line

You can then specify which console line is assigned to each node. A console line can be assigned to multiple nodes (this will duplicate the DMX universe), but each node should have only one console line assigned to it.

Here, the console assigns the following:

- Line A to Box 1 universe 1 and box 2 universe 1
- Line B to Box 1 universe 2
- Line C to Box 2 universe 2 and the dimmer rack

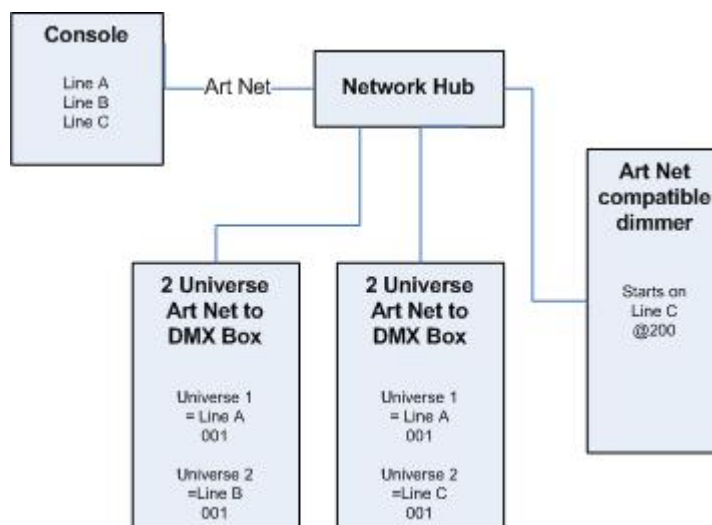

14.1.4 Setting up an Art-Net system

For this example, it is assumed that you will connect the console to an Art-Net DMX output box (such as an Artistic License Net-Lynx) via a network hub.

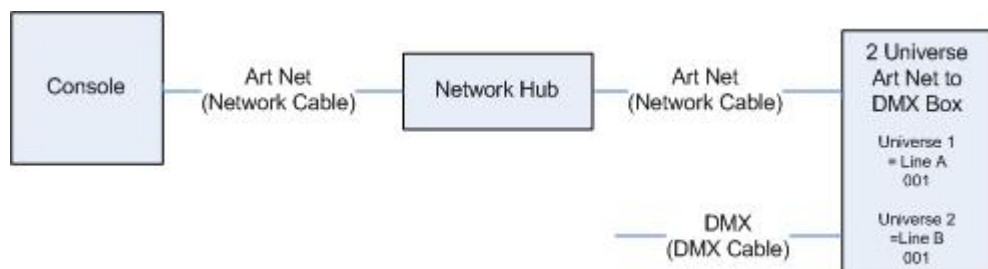

Using standard RJ45 ethernet cables, attach the devices together.

- If you are using a hub/switch as shown above, use straight-through patch cables. If you are directly connecting the console to another Ethernet device you need to use crossover cables.

Set the Net-Lynx box as follows:

- Subnet Mask = 0
- DMX A Universe = 1
- DMX B Universe = 2

A lot of Art-Net devices, including the Net-Lynx box, are set to IP address 2.x.x.x as default, and can be set to 10.x.x.x using an option jumper, so you should check what the setting of your device is.

If your Art-Net devices need to be set to a non-standard IP address, then in steps 1 and 2 you need to use Windows Control Panel to set the console to that address range instead of 2.x.x.x

With everything connected, start the console.

-
- 1> *Ensure the console has an IP in the 2.x.x.x range as described at the start of the chapter.*
 - 2> *Switch the console to System and select [DMX Settings].*
 - 3> *The DMX Settings window should open.*
 - 4> *Select the Art-Net module from the node list in the left hand side of the window.*
 - 5> *Press the small 'i' button to show the node properties. Ensure that the correct Network adapter is set (this may not be the Default Adapter)*
 - 6> *If you wish to turn off the Art-Net output, you can unselect the "Enable DMX output" option. This will stop the Console from outputting Art-Net on any Lines.*
 - 7> *Art-Net normally only sends Data when it is changed, rather than a continuous stream. There are times when it is preferable to send Art-Net all the time. to do this, select the "Continuous Art-Net Data Stream" option.*
 - 8> *The "Always broadcast Art-Net" option enables you to send Art-Net to the entire network, rather than a specific IP address.*
 - 9> *Press the blue → arrow on the Art-Net node to connect it to a DMX output line.*
 - 10> *Select a console DMX line from the right hand side of the window.*
 - 11> *The DMX line will now be outputting over the selected Art-Net node.*
 - 12> *Click 'i' on the node you have added to make sure the properties are correct. (Problems can be caused if you attach multiple DMX lines to a single node.)*
 - 13> *Make sure that the Universe is set to 1 for Line 1, and 2 for Line 2.*
*Art-Net uses a subnet mask with its universe. For Titan purposes:
Titan universes 1 - 16 are subnet mask = 0, Art-Net universes = 1 - 16*
 - 14> *You can close the DMX settings window.*
-

The console should now be working correctly.

To remove a node from a DMX line, select the node and click the blue X button.

"Unpolled" and "unknown" devices may appear as Art-Net nodes.

- An unpolled device is a 'rolling extra' which allows more than 4 connections to be made to a particular Art-Net device. The Art-Net specification only allows each device to advertise a max of 4 universes so if you need to add more the console has to invent the 5th, 6th, etc universes.

- An unknown device is one which doesn't format an Art-Net poll reply properly so the console doesn't know if it is an input or output device.

14.1.5 Additional Art-Net Resources

To find out more information about Art-Net please refer to the Art-Net Standard published by Artistic Licence.

14.2 Connecting to a simulator with ACDI

ACDI is Avolites' Application for Interfacing Consoles and Simulators with lighting software such as Visualiser, Capture or Show designer.

14.2.1 ACDI

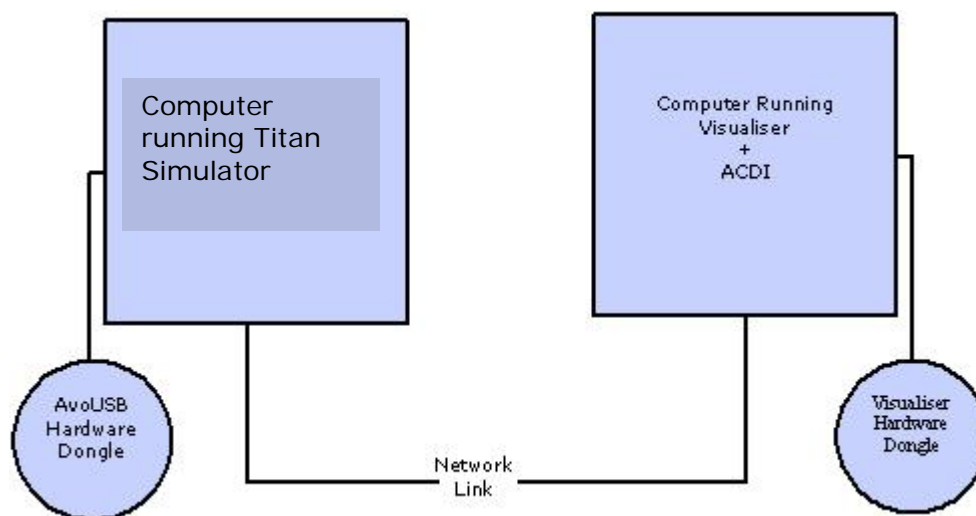

The network link connection can be made through either a crossover cable, or through a network hub.

For this example, both computers are connected together via a crossover cable.

First, we will set up the Network setting for both computers. It is important that both computers use an IP address in the same range (2.0.0.x in this example) and have the same subnet mask, or they won't be able to communicate.

On the console, set the address to 2.x.x.x as described in section 14.1.1 at the start of this chapter. If you need to set a custom address to match the visualiser PC you can use Control Panel to do this.

On the computer running the Visualiser:

-
- 1> Click Start, Control panel, Network connections.
 - 2> Right click on the connection you wish to use.
 - 3> Click Properties.
 - 4> In the connection properties window select TCP/IP and click Properties.
 - 5> Set the PC network adapter to a free address on the network in the range 2.0.0.x.
 - 6> Set the subnet mask to 255.0.0.0.
 - 7> Click OK.
-

Close any network windows on both machines.

Install and run ACDI on the Visualiser Computer.

In ACDI change "Source" to "Simulator"

Do not close the ACDI window

Refer to the previous section to setup a DMX line on the console to be sent to the Visualiser.

Finally, start the console, and open or create the theatre file. (See the Visualiser manual for more information on this)

Once ready to connect to the console, go to run mode in the Visualiser, and select simulator under DMX.

The console should now be working with the Visualiser.

14.3 Module Setup

A module is a method of sending DMX and can be thought of as a collection of nodes.

For example, consider using wireless networking technology to transmit DMX to several individual receivers. Each receiver is configured to output a specific universe of DMX. In this case, the wireless system as a whole is the module, and each receiver is a node.

You can set the specific properties of the Modules used with the console by going to the DMX Settings window (switch to System mode and select [DMX Settings]) and then click the small 'i' at the right hand side of the module name.

This allows you to adjust settings for each module, and to select a network adapter for ACDI and Art-Net. The consoles only have one network adapter, however on Titan Mobile and Simulator this depends on your computer; many laptop users will have their standard network adapter and also a Wi-Fi (wireless) adapter, both of which will be shown.

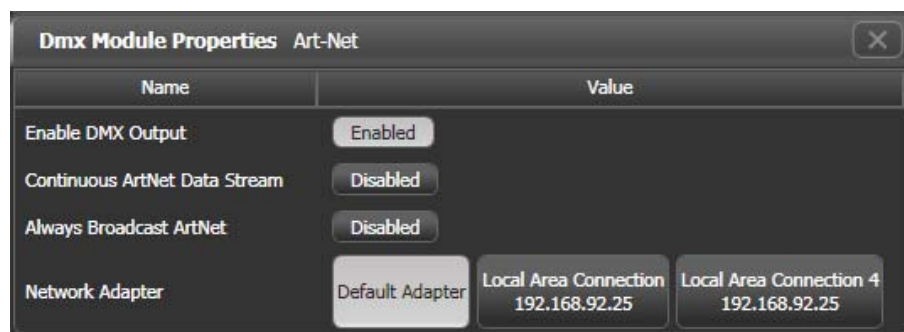

14.4 Using Active Fixtures with CITP

CITP is a standard system allowing lighting devices to communicate and share information. This is often used with media servers to allow the console to get media thumbnail images and layer information from the server. The thumbnail images can then be used on the console to select media clips.

14.4.1 Example CITP setup

This example shows how to set up a Hippotizer with the Tiger Touch.

-
- 1> *Connect the console and Hippotizer to the network. (You can connect the Hippotizer directly to the console, if no other devices are being connected, using a crossover patch cable).*
 - 2> *Set up the IP addresses and subnet masks of the console and Hippo so that they are on the same address range, for example 192.168.0.1 and 192.168.0.2.*
 - 3> *If you are using Titan Mobile or Titan Simulator ensure the firewall on your PC is disabled. Also ensure the Hippo machine is not running a firewall.*
 - 4> *Run the Hippo system. Make sure the CITP component is running.*
 - 5> *Switch the console to System mode and select [DMX Settings].*
 - 6> *On the left hand side under Art-Net you should see the Hippo with its IP address. Click on it and then on the right hand side click on the DMX line you want to use it with.*
 - 7> *On the Hippo node on the left hand side, click the 'i' button and set the Universe number to match the universe setting on the Hippo.*
 - 8> *Exit System mode back to the default menu.*
 - 9> *Restart the console software using the option on the Tools menu.*
 - 10> *Go into Patch mode and select [Active Fixtures]. You should see the Hippo with its IP address as a softkey option.*
 - 11> *Select the Hippo, then set the DMX line to match the line you set in Step 6.*
 - 12> *Press an empty fixture handle to patch. The console will automatically patch the required layers and master layer as a series of fixture buttons.*
 - 13> *Now if you select a fixture and open the Attribute Editor window you should see the media thumbnails.*
-

The next time you start the system, ensure the Hippo is powered up before you start the console.

If you decide to re-patch to a different DMX address you will need to re-start the Hippotizer software. You will also need to reset the Art-Net nodes if you are moving across DMX lines.

14.5 All about IP addressing

This section attempts to explain the basics of IP addressing, and what you will need to know when setting up a lighting control network.

IP addresses will normally come in the format "w.x.y.z" where w, x, y and z are numbers between 0 and 255. For example "298.23.46.166". Every object (or node or device) on a network should have a unique IP address. This is the same concept as DMX as each fixture requires a unique DMX address, for IP addresses the same is required.

14.5.1 Setting your IP address

The console has a setup function to quickly set its IP address as described on page 209

There is a strong possibility that if you set the IP address on one network device you will have to set it on all of them, therefore if you manually set your IP address on the console you will have to do it on any TitanNet devices you are using and any Art-Net fixtures. Beware that some Art-Net fixtures have a fixed IP address in the range 2.x.x.x, in which case you have to set the console to that range.

14.5.2 Subnet Masks

These are best kept simple. All devices or nodes on a network who wish to communicate with each other must have the same subnet mask. The mask determines which parts of the IP address are unique in that network to each node. If the part of the subnet mask is a 0 then the corresponding digit in an IP address must be unique for each fixture. If the part in a subnet mask is 255 then this part of the IP address needs to be the same for each node.

14.5.3 Choosing an IP address and Subnet Mask

This is the hardest part of setting up a network as your IP address totally depends on what you are using on the network and what IP addresses you can and cannot change. Below are a number of different scenarios for standard lighting networks using a Titan console and what IP addresses should be set. These aren't guaranteed to work but try them if the scenario matches your network:

Titan and ShowSafe, all output is standard DMX.

	IP Address	Subnet Mask
Titan console	192.168.1.30	255.255.255.0
ShowSafe	192.168.1.31	255.255.255.0

Titan outputting over Art-Net Fixtures (and DMX).

	IP Address	Subnet Mask
Titan console	2.100.100.100	255.0.0.0
Art-Net Fixtures	2.x.y.z	255.0.0.0

Or

	IP Address	Subnet Mask
Titan console	10.100.100.100	255.0.0.0
Art-Net Fixtures	10.x.y.z	255.0.0.0

Where a combination of x, y and z are unique for these fixtures.

Titan and ShowSafe outputting over Art-Net (and DMX).

	IP Address	Subnet Mask
Titan console	2.100.100.100	255.0.0.0
ShowSafe	2.100.100.101	255.0.0.0
Art-Net Fixtures	2.x.y.z	255.0.0.0

Or

	IP Address	Subnet Mask
Titan console	10.100.100.100	255.0.0.0
ShowSafe	10.100.100.101	255.0.0.0
Art-Net Fixtures	10.x.y.z	255.0.0.0

Where a combination of x, y and z are unique for these fixtures.



Never set the last number of an IP address to be 255. This is a special address which will not function correctly.

14.5.4 Automatically assigning IP addresses (DHCP)

There is another way of assigning IP addresses via an automatic system called DHCP. For this you need one of the devices on the network to be a DHCP server. If you know none of your devices are a DHCP server then this is irrelevant however, if you have a router on the network or some such similar device then it is likely that you have a DHCP server. If you do then in the 8 step instructions in section 14.5.1 on page 215 when you come to step 7 you should ensure that "Obtain an IP address automatically" is selected then press ok. When you are using DHCP all the devices on the network must be capable of obtaining an IP address automatically. If one device cannot (eg some Art-Net devices) then you must manually set all the IP addresses.

14.5.5 Private IP address ranges

If your network is connected to the internet it is important to use a private IP address range. These are special IP addresses that will not be routed onto the internet. They are:

Start Address	Final Address	Subnet Mask
10.0.0.0	10.255.255.255	255.0.0.0
172.16.0.0	172.31.255.255	255.255.0.0
192.168.0.0	192.168.255.255	255.255.255.0

For Art-Net, the 10.x.x.x range must be used.

15. Using different Avolites consoles

If you are used to other Avolites consoles, this section will help you to cope with the differences between each console.



Shows from a Titan console can be loaded into any other Titan console, but not into the Pearl Expert running Classic software, or a Diamond 4, or a Pearl 2000/2004/2008 console, because these consoles have a different show file format.

15.1 The console controls

Obviously the main difference on the Tiger Touch is the touch screen, and the lack of preset faders.

Touch screen

The touch screen provides a user-configurable 'workspace' which can show windows containing buttons for fixtures, palettes, groups, shapes, attribute control and more. You can select which windows are visible, and their size and position, using the Window Control buttons above the numeric keypad, and the window buttons to the right of the touch screen. The View menu also gives you some options. You can store different workspace layouts in the 'workspaces' touch keys.

The right hand side of the touch screen is the menu area. This is very similar to the LCD panel on a Pearl Expert. To activate the menu buttons you can either touch the screen or press the button alongside.

You can lock any menu (to keep it active) by pressing the Menu Latch button. The Menu Latch button (ML Menu on other consoles) only shows its menu at the top level screen.

The bottom of the touch screen gives information about the playback faders below.

When a text input is required, a touch keyboard pops up for you to enter text.

When selecting a range of fixtures, you have to use the touch screen slightly differently to how you'd use buttons; touch and hold the first in the range, then touch and hold the last, then release the first; or you can drag your finger along the buttons.

Preset playbacks

As well as the 10 playback faders across the bottom of the console, there are 10 further playbacks on the top right of the console. These always stay the same (they aren't affected by the page buttons) and so are useful for memories you use a lot, such as par can washes, basic stage illumination or smoke machines.

Using Pearl Expert shows

If you are using a show from a Pearl Expert, anything programmed on the preset faders won't be visible as the Tiger Touch doesn't have any preset faders. However, by opening the Fixtures and Playbacks window (press View, [Open Workspace Window], [Fixtures and Playbacks] or [Groups and Palettes]) you can access fixtures, playbacks, groups and palettes from the preset faders. If you wish you can copy items to a normal workspace window using the [Copy to Workspace] context button.

Cues and Chases on the touch screen

In addition to the playback faders, you can store cues (memories) and chases on the touch screen using the Playbacks window. For playbacks which don't need a fader, this gives you instant fingertip access to an enormous number of effects.

Macro buttons

10 buttons are provided in which you can store frequently used button sequences. Any sequence of button presses can be stored in each of these buttons making those repetitive programming tasks a thing of the past. If you need more than 10, you can show a Macro window on the touch screen. The 10 console buttons are the same as the first 10 Macro touch buttons.

Change button functions

You can change the functions of the blue and grey buttons on the console to give you quick access to the functions you want, such as Preload, Stop and Go for chases, Tap Tempo and so on. This feature is called Key Profiles (see page 195).

15.2 Programming features in Titan

There are some great programming features in Titan consoles which previously were only found on the Diamond 4.

Fixture Overlap, Attribute Overlap

The overlap functions allow you to sequence the way a cue plays back. Normally when you fire a cue, everything would move to its programmed setting all together. The Fixture Overlap feature causes each fixture to move to the new setting in sequence, giving some amazing roll or peel effects without any programming. Attribute overlap is a similar effect with different attributes. When "busking", palettes can also be applied with overlap.

Fixture Exchange and Copy Fixture

The Fixture Exchange function enables you to replace fixtures which are used in your show with alternative fixtures, retaining important elements such as cue times, shapes and legends. It is very useful for touring shows and venues with a high turnover of events, allowing you to cope with different house rigs or equipment availability.

You can copy fixtures you already have in your show. The new copy will come complete with all the cues and palettes of the original fixture you've copied.

Multiple times

The Titan software allows multiple timers for cues. This means in a complicated show you can have lots of fades going on from different cues each under the control of a different timer.

Playback priorities

You can configure how playbacks will behave if you turn on two playbacks controlling the same fixture. For each playback, priority can be set to Low, Normal, High or Very High. If a fixture is being controlled by a playback and you turn on a playback of the same or higher priority, then the new playback will take over. However, if the new playback is set to lower priority than the first playback, the fixture will not change.

This is useful if, for example, you've programmed looks using all your fixtures, then you decide you want a couple of them to spotlight a singer. If you set the Spotlight playback to be high priority, then while it is active no other playback will affect the spotlight fixtures.

Undo/Redo

Undo/Redo buttons allow you to undo an action if you do something and later regret it.

Release

When a playback is killed, you can set how the LTP channels release. The default setting is to not release any attributes (i.e. LTP channels will not change when the playback is killed), but you can set attributes to revert to their state in the most recently active playback.

16. Release notes

This section describes changes in the most recent version of software.

Please ensure you save and backup your shows before attempting to upgrade any software.



This section only lists the changes in the most recent update; for changes in earlier versions, please check the release notes provided on the console using the VDU menu option Help → Release Notes.

16.1 Version 7.0

16.1.1 Upgrade instructions

Upgrading from: Consoles 5.x: For consoles there is no upgrade path from versions prior to 6.0 and so the software must be installed by running a 6.0 recovery stick followed by the 7.0 installer. You can download the 6.0 recovery stick containing from Avolites v6 Upgrade. Please follow the instructions given when downloading the recovery stick to install version 6.0 and then follow the instructions for upgrading from 6.x.

Upgrading from: Consoles 6.x: Please ensure you save and backup your shows before attempting to upgrade any software. An automated upgrade path from Titan 6.x is provided. You can download the latest Titan software by clicking on the relevant console [here](#). Full instructions for upgrading both with an installer and a recovery stick are supplied with the download and can be found in the console manual. The installer upgrade procedure is reproduced briefly below: Please save the software to a USB stick or other media and follow these instructions: Shutdown the software by selecting 'Shutdown Software' from the tools menu. Insert the USB stick in the console and click on the yellow 'Folders' icon on the tools menu of the console. Find the setup file you saved to the USB stick and double click to run it. Follow the instructions presented by the installer, taking care to read each step carefully. Once the setup completes you need to restart the console. When the console restarts it should be updated to the new software, please check this by reading the version number in system mode.

Upgrading from: PC any version: Please note that as of version 7.0 Windows XP operating systems are no longer supported. Supported versions on Windows are Windows Vista, Windows 7 and Windows 8. This affects Titan One, Titan Mobile, Titan Simulator and Personality Builder. Please ensure you save and backup your shows before attempting to upgrade any software. An automated upgrade path from Titan 6.x is provided. You can download the latest Titan software by clicking on the relevant console [here](#). Please download the setup file to your computer. When it has finished downloading find the setup file and double click to run it. Follow the instructions presented by the installer, taking care to read each step carefully. Once the setup completes you need to restart the computer.

16.1.2 New Features

Remote: It is now possible to remotely control the console via Android and iOS devices.

You can choose to connect to any console connected to the same network as the device. This will automatically load a mirror of the show onto the device and allow control from both the remote and the console at the same time. Any changes made on the remote will update on the console and vice-versa.

You can switch between fixture, palette, group and cue (playback) windows which complement their counterparts on the console. The palette window can be switched between position, colour and beam windows. All windows are pageable. Any items already in the show will appear here and items that have scribble legends will display with their picture. Fixture handles also display the fixture DMX start address to help check settings when on stage away from the console. Fixtures can be recalled using groups from the groups window or selected directly from the fixture page or numerically via a keypad that can be toggled on/off.

There are buttons for locate, clear, highlight (toggle), next, prev, all, undo and record. Attributes are selected for control using the IPCGBES attribute group buttons. Where an attribute group contains more than three attributes pressing the button again will page through. Attributes are controlled by dragging up or down on the appropriate thumbwheel or by touching on the function. Cues, palettes and groups can be recalled and recorded in their respective windows. When recording you can set a text or picture legend and colour palettes will automatically provide a relevant colour scribble to use.

Network Backup: It is now possible to backup consoles over a network. Any console can act as a backup for any other console.

A console can be set as a backup from Disk/[TitanNet Sessions (Backup)]. Any consoles available to backup will be shown in the sofkeys. Choosing one of these will automatically sync the show and place the console in backup mode. In backup mode a screen displays the current connection and sync status including current show name. A green line between consoles represents a good connection. If a red line is shown there is a problem with the network connection. A blue line will appear during sync operations. Shows will automatically sync whenever a show is saved on the console being backed-up (including autosave). You can also choose to sync at any time by selecting [Sync Now]. Pressing [Exit] will abort backup. [Takeover] will enable control on the backup console and disable DMX output on the console being backed-up. A prompt will then appear on this console to warn that DMX has been disabled. On touch consoles touching on this prompt will open the 'Exit Safe Mode' menu with a softkey option to re-enable output. On the Pearl Expert you can re-enable DMX output via the shift (Avo) menu.

Show Import: You can now import items from other shows into the current show.

From the Disk menu there is a new option [Import Show] and in the Show Library workspace there is a [+] button in the top-right corner and an 'Import Show' context menu option. Selecting any of these

options will present a list of available shows to import and the Show Browser workspace will automatically open. To import a show either select it on the softkeys or select it in the Show Browser workspace and press the [Import] button. Imported shows will then appear as buttons at the top of the Show Library workspace alongside the current show. Multiple shows can be imported at the same time.

After selecting a show you can view all the items in the show and assign them to handles in the current show. In order for items to work properly the original fixtures must first be mapped to fixtures in the current show via the Mapper tab. One or more of the imported fixtures can be selected and mapped to current fixtures by clicking on the arrow. There is a context menu option 'Clear Fixture Mapping' to remove any mappings. When mapping fixtures it is possible to filter both the imported and current fixtures to make it easier to navigate.

Times in Programmer: It is now possible to set, edit and review times in the programmer before a cue is recorded.

There is a new TIME key. On Titan Mobile and Sapphire Touch consoles this is the key above clear (previously labelled 'SET'). On Pearl Expert and Tiger Touch consoles this is the key between REC STEP and SNAP BACK (previously labelled 'NEXT TIME').

Pressing this key will open the Edit Programmer Cue Times menu. From here you can set global times or, by entering the relevant sub-menus, attribute group and individual attribute times. Where any value is changed it will highlight as 'in programmer' in the same way as attributes in the wheel view. These values can then be recorded or merged into cues or palettes just like attribute values.

There are various syntax shortcuts. Examples are as follows:

- TIME 5 = 5sec fade in
- CUE 3 TIME 5 = 5sec fade in on connected playback's cue 3
- TIME FIXTURE 5 - 5sec fade in for all attributes of selected fixtures
- TIME FIXTURE G 5 - 5sec fade in for gobo attribute group of selected fixtures
- TIME FIXTURE @B 5 - 5sec fade in for attribute connected to wheel B on selected fixtures
- 5 @ 3 - 5sec fade in, 3 sec delay
- 5 AND 2 - 5sec fade in, 2sec fade out
- 1 THRO 10 - times spread across fixtures according to selection order

Individual attribute times can also be set by wheel. From the root menu there is a new [Wheels = Level]/[Wheels = Fade Time]/[Wheels = Delay Time] toggle. When set to [Wheels = Fade Times] or [Wheels = Delay Times] the wheels control the fade in or delay in times for the connected attribute(s) respectively. On touch consoles you can choose whether you are controlling delay or fade by touching on the relevant control in the wheel view.

The Channel Grid workspace now has an extra 'Times' context option which provides a way to view all attribute times currently in the programmer. Selecting cell(s) allows direct editing of the relevant time. When editing group or individual attribute times there are additional softkeys to set back to global, turn off and turn on. Times set to off in the programmer can be merged into existing cues or

palettes to (temporarily) remove a time value. Times set to on in the programmer can be merged into cues or palettes to restore time values that had previously been turned off.

While setting time values in the programmer it is possible to 'try' them out as you go. This can be accessed at any time by shift+TIME or double-tap TIME. You can even temporarily toggle times off and on while in the programmer and test them with and without using the try cue function.

There is a new toggle in clear options to [maintain cue times] or [clear cue times] (default). [Clear cue times] will remove all times from the programmer on clear. [Maintain cue times] will leave any times in programmer after clear. It is also now possible to bring times into the programmer from a cue by using include and, when using advanced include, there is a new softkey to toggle between [ignore cue times] and [include cue times] (default). Additionally all mask menus now have a 'time' flag that can be used to include or exclude times where appropriate. Finally there are new context menu options in Channel Grid, Playback View and Cue View/Times to show or hide time palette references where applicable.

Time Palettes: It is now possible to record times in palettes. These can be shared or normal and can contain playback times and fixture attribute times.

Where cues are recorded using a time palette updating the palette time will update the cue time. If a palette contains attribute values as well as times it is possible to recall the palette using it's times. This function is enabled/disabled in palette key profiles as [Palette is fired with its times]/[Palette is fired ignoring its times]. Default is to fire without times. In either case if a time is entered manually it will always override the palettes internal time.

@ Menus: The @ buttons in relevant consoles now open the Adjust Attribute Value menu for the connected attribute (on the Tiger Touch the three buttons between the wheels now function as @ buttons). This menu is also accessible by clicking on a cell in the channel grid and by touching the center of a connected attribute in the wheel view.

The following options are available:

- Select Function - Opens a second menu of available functions for the attribute. When the attribute is a dimmer this menu will provide shortcuts to 0%,25%,50%,75% and 100%
- Touch/Clear - places attribute in programmer in current state/clear attribute from programmer
- Locate - locate selected attribute (does not enter programmer)
- Release - release selected attribute
- Off - set attribute control off
- On - set attribute control on
- Freeze/Un-Freeze - Freeze/Un-Freeze selected attribute

Note regarding on and off: These values can be merged into existing cues or palettes to turn values off and subsequently restore back to their previous value with on.

Attribute On: In addition to the mergeable 'in-programmer' option in the new @ menus it is also now possible to directly restore values previously turned off from cue view. When one or more cells set to 'off' are selected, softkey A ([ON]) will restore those cells to the values they had prior to being turned off. Pressing the OFF function key will also toggle selected cells on or off.

Set List: There is a new workspace called 'Set List'. For those times when you just can't find a suitable place for that piece of paper, or when you can't see it without a torch!

A set list is made up of 'tracks'. On all consoles except Pearl Expert when a track is added it links to the current page and pressing the play button next to a track will automatically select the associated page. It is also possible to 'bind' the page change buttons to step through the active set list and its associated pages on consoles with physical page up/down buttons. Pages can be changed to 'Set List' mode via a toggle in the Set List context menu or after touching the centre of the page area.

For every track you can add notes. The associated notes for a track will be shown as soon as you 'play' a track or just by clicking on a particular track.

You can create multiple set lists in a show. When creating a new set list by pressing on the [+] button at the top of the window you can choose between 'empty', 'pages' and 'build'. 'Pages' will automatically create a set list for you based on pages that contain cues using the page legends as track names. 'Build' provides a way to quickly make a new list by selecting tracks from other lists. You can also 'park' and 'unpark' any tracks as required and you can filter the view to just show the remaining active, just the parked or both. When showing both, the parked tracks are greyed-out and the play icon is not available.

You can rename set lists and tracks by using [Set Legend] and selecting the item you want to rename. You can also copy, move or delete tracks using the respective function buttons in the console.

Group Intensity Masters: It is now possible to assign groups to faders.

The fader will then control the intensity of fixtures contained in the group. The associated blue key will select fixtures in the group and holding the blue key will provide the option to filter according to a pattern.

Various behaviour modes can be set in [Playback Options]:

- Scale Master - Proportional control (default)
- HTP - Override level if higher
- Limit - Hard limit
- Take Over - Place fixture and its intensity in programmer on level match
- Disabled - Ignore fader

When set to zero the handle LED will pulse. On touch consoles the current level percentage, mode and bargraph level representation will be shown in the playbacks touch display.

Note - when a group master is set to disabled or moved to a handle without fader it will become locked at the current fader level until it is re-enabled and/or moved back to a fader as appropriate.

Pixel Map Layer Masters: It is now possible to assign four new pixel mapper layer masters.

Each of the four layers in the Effect Editor has a switch to enable or disable control of the layer by a master. When a layer has been assigned to a master you can adjust all the layer controls as like you would any other fixture and where a layer master is assigned to a fader handle the fader will control opacity. This means you can create and fire cues, chases, lists or palettes (including fade times) which will manipulate the layers of any active effects which have the master control enabled.

Note that you may need to update the personality library to allow assigning of layer masters.

Attribute Limits: You can now set upper and lower limits for any attribute.

Limits can be set or viewed from the Patch menu (via the [Edit Fixture] menu), from the Patch View and from Fixture View. In Patch View these are available from the Attribute Behaviour tab- choose the behaviour you wish to view or adjust from the context menu. After choosing your attribute(s) the Set Limit menu will open. Here you can either input a value or use [Set to Current Value]. There is also a [Remove Limit] option if required.

Note that it is still possible to place values into the programmer that are outside these limits. On touch consoles a 'limit' watermark will appear on the wheel view behind an attribute when it is being limited.

Fixture Curves: It is now possible to set curves per attribute/fixture.

Curves can be set or viewed from the Patch menu (via the [Edit Fixture] menu) and from the Patch View. In Patch View these are available from the Attribute Behaviour tab. Choose the behaviour you wish to view or adjust from the context menu.

Attribute Behaviour: There is a new tab in Patch View named 'Attribute Behaviour'. This provides a way to view and edit attribute behaviours such as curves, limits, invert and freeze. You can choose which behaviour you want to view/edit from the context menu. Selecting an attribute cell or cells will open the relevant menu for editing. There is a new filter at the bottom-left of the patch menu to show all fixtures or just those that have modified behaviours.

Streaming ACN: It is now possible to output DMX using Streaming ACN.

RDM (Remote Device Management): RDM is now supported in Titan. A new RDM tab has been added to Patch View. Any connected devices that support RDM will be displayed here with information including manufacturer and model name, current mode and address and number of channels used. 'Full Discover' from the context menu provides a way to force discovery of fixtures. Modes and address can be changed remotely by clicking on the relevant cells. Clicking on the 'identify' button provides a way to visually identify which fixture this is in the rig. Selecting the patch button will patch the associated fixture. Alternatively the context menu option 'RDM Quick Patch' provides a way to quickly patch all discovered RDM fixtures.

Find Fixture: The Find Fixture function provides a way to identify the start address of a fixture when it is not known or if a fixture is not responding as expected.

This can be toggled on/off via the Patch Fixture/[Options] menu. On touch consoles the current state of the function is detailed above the wheel display. By default find fixture is turned off. When enabled the console will output locate values for the chosen fixture at the current line/start address.

You can now use the wheels to set line & start address. On consoles with three wheels wheel C (DMX slot) provides a quick way to jump forwards or back by the offset value from the start address (by default the offset is the fixture channel count). Touching in the top or bottom sections of the wheels increases or decreases the relevant value respectively.

Reports: It is now possible to export information about your show.

Reports are accessed via Disk/[Reports] and the information can be filtered to:

- Fixtures (default)
- Memory
- Chases
- Cue Lists
- Palettes
- Groups

There is also a dedicated [Export Patch] option from the Patch menu and the Patch View context menu. This contains useful information such as user no, fixture name and mode and address along with how often a particular fixture has been used. The reports also contain other useful details such as the show name and creation date.

Reports can be formatted as HTML, PDF, CSV or XML. You can choose destination between internal and external storage (where present) and when a report is generated Explorer will automatically open in the containing folder so you can see where it went.

Show Browser: There is now a new Show Browser workspace. This automatically opens when you choose to load or import a show. This provides a way to view and search all shows available depending on location and type filters and choose to load or import. Show folders detail how many versions they contain. Actual show versions contain timestamp details. Select a show and then load or import as required.

Show Library Button Display: The Show Library workspace has been overhauled. There are now dedicated buttons for filtering and there is a new context menu option to toggle between the old 'grid' display and a new 'button' display (default). Button display represents items as handle buttons in their standard colours and are organised according to handle group and page.

View Tracked: Cue view now has a context option to view tracked values. When turned on (default) tracked values in cues are shown in light grey.

Cuelist Fire First Cue: In Playback Options for Cue lists there is a new softkey toggle to enable/disable firing the first cue. When enabled the first cue will immediately go as soon as the cue list is fired. Default is disabled.

Disable Cue List Cue: Cues in cue lists now have a new 'disable' option. When a cue is set to disabled it will be skipped. This provides a way to temporarily remove a cue with the ability to reinstate later if required. On touch consoles disabled cues are 'greyed out' in the connected wheel display.

Flash with times: A new key profile option is available to flash with times.

Effect Palettes: It is now possible to record effects in palettes. These effects can then be applied to any group layout. Any changes to effect palettes recorded in cues will update the associated cues.

Palettes on TT executor buttons: It is now possible to record palettes on the Tiger Touch macro/executor buttons.

Remove Fixture from Cue: It is now possible to completely remove a fixture from a cue - View the cue, select the fixture(s), [Remove Fixtures],[Confirm].

OFF Playbacks: It is now possible to directly turn off fixtures/attributes and remove fixtures from shapes in playbacks.

Press OFF followed by a playback to open the 'Off Playback with Mask' menu. Select fixtures, set mask as required and then press [Off] to turn the fixtures/attributes/shapes off.

Note that for consoles that do not have separate Release and Off buttons pressing Off followed by a playback will release it. In these cases select [Off Playback Values] then select playback.

Add Fixtures to Shapes: There is a new context menu option in Shapes Fixture View called 'Add Fixtures'. This provides a direct way to add more fixtures to a shape in an existing cue. After selecting the context menu option, select fixtures you want to add and then press the [Add Fixtures] softkey to add.

Patch View Column Filters: There is a new context menu option in Patch View called 'Choose Columns'. Pressing this will open a menu where you can toggle columns on/off for the patch view. This is useful to help simplify the view or to ensure particular columns are visible when using smaller window sizes and/or displays.

Patch View Notes: You can now add notes to fixtures in the patch view.

View Fixture History: There is a new tab in Fixture View called 'Personality'. When selected this will display the personality's history. This can be useful for checking versions and changes.

Reset Masters: You can now reset any master to its default level by pressing release (or OFF) followed by the master. If the master is assigned to a fader you must level match to regain control.

Disable DMX Output: It is now possible to disable/enable DMX output from the shift (Avo) menu. This is particularly useful in backup situations, for example two consoles outputting to Art-Net or if physical DMX outputs are merged.

Fan in Layout Editor: Fan now functions in the layout editor to provide an easy way to evenly spread fixtures.

TNPN Network Adapter View: It is now possible to view the current network adapter and IP address of a TitanNet Processing Node on its main screen to help with identification.

TitanNet Event Log: There is a new workspace called 'Event Log'. This provides feedback and history on node connection and current status.

16.1.3 Improvements

Patch fixture performance: Some changes have been made to improve fixture patch performance.

Shapes with large numbers of fixtures (performance): Improved performance with large numbers of shapes in programmer.

Latch numeric menu: It is now possible to latch the numeric menu. This is particularly useful if you want to hold a manual palette fade time.

DMX output workspace user number: A user number column has been added to DMX view to help identify fixtures.

Align shapes: You can now align shapes.

Layout editor auto-scroll: The layout editor window will now auto scroll when resizing the grid.

Phase Offset in palettes: You can now store phase offset in shape palettes.

Preset colour palette picture: Preset palettes now automatically create scribbles in the colour palettes workspace.

Enter to exit mask menu: You can now press <enter> to exit a mask menu.

Change cue number from Set Legend: It is now possible to renumber cues in a cuelist from the Set Legend menu.

Fader control of dimmer patched on TT static and ST wing handle: It is now possible to use the fader to control dimmer level when fixtures are patched to the Tiger Touch static playback faders and the Sapphire Touch wing.

Frozen indicator on wheel display: A 'frozen' watermark is now shown in the wheel display of touch consoles for any frozen attributes or fixtures.

Active fixture linking by exchange instead of update: Active fixture linking is now achieved via an exchange rather than an update in order to improve the function.

Compress bitmap thumbnails: Thumbnail bitmaps are now compressed to prevent unnecessarily large shows and potential adverse console performance as a result.

Distributed Pixel Mapping: Pixel Mapping is now rendered locally on the relevant TNPN to improve performance and prevent network overload in large pixel map configurations.

View shape/effect at the same time as cue: You can now have shape and/or pixel views open at the same time as cue view.

Show 64 lines in DMX view: You can now view all 64 lines in DMX view.

OFF in channel grids: The OFF function key can now be used to switch selected cells off (and on where appropriate) in cue view and channel grid.

TitanNet resilience: Improvements to resilience of loss of nodes or where nodes are rebooting. Includes feedback to user on current state.

Wireless adaptors and Art-Net: It is now possible to use wireless network adaptors to output Art-Net.

T1 wheel display text area enlarged: The T1 wheel display text area has been made larger to resolve issues where the text display was truncated on certain display/window sizes.

Docked legend in cue list view (playback): The legend column in playback view is now docked so that if you have to scroll to the right it remains in view for easier identification of cues.

Delete shape from cue: It is now possible to delete shapes in cues directly by pressing delete followed by the fixture in shape fixture view then [confirm].

Fixture order in cue view: It is now possible to view the fixture order number of each fixture in cue view.

16.1.4 Changes

Showfile Versions: Showfiles now support versions. The name of the current show is shown in the disk menu. When creating a new show there is an option to give it a name (default = 'unsaved show').

There are now [Save] and [Save As] options in the disk menu. [Save As] will allow you to create a new show which will be stored in a separate folder and this will become the name of the current show. [Save] provides a way to save versions of the show within this folder. The first version will be called 'Initial Version'. If a new show has not been named pressing [Save] will initially send you to the [Save As] menu.

When in the 'Save A Version' menu you can optionally enter a tag for the version or use the default QuickSave's. Autosaves will be saved within the show folder. Pressing the Disk button twice will create an autosave in the current show folder. Every version saved will create a new file, even if the tag is identical.

When you choose a show to load you will be presented with a list of all the available versions of the show.

User Personality Directory: When a personality is edited it will now be stored in the custom personality directory. This provides a way for the factory personalities to be updated without affecting user edited personalities. Edited personalities will appear with '(user)' appended to the fixture model when patching. If a copy of the personality cannot be found on the console a copy will be created from the showfile to allow editing.

Very High Priority overrides palettes: Values in playbacks set to very high priority now take precedence over palettes applied to fixture selections.

Renumber changes: 'Renumber cues' has been renamed 'Renumber ALL cues' and a prompt with [Confirm] or [Cancel] has been added to prevent accidental operation. A Renumber All Cues button has also been added to the Playback Options menu so that it is easier to find.

Renumber cue from Set Legend: It is now possible to renumber individual cues from the Set Legend menu.

Remove show loaded prompt: The show saved/loaded [OK] prompt has been removed. Following a successful save or load you will now immediately be returned to the root menu.

TM executor buttons key profiles: The Titan Mobile executor buttons are now treated as touch keys in key profiles.

Reordered cue list cue times menu softkeys: The Edit Cue List Cue Times menu softkeys have been reordered to keep similar settings within pages.

Prevent fixture cell deletion: Previously it was possible to delete individual cells after unfolding a fixture. Attempts to do this will now be blocked and a warning is shown instead.

Removed preload from cue list view: Preload has been removed from cue list view as it has been made obsolete with the introduction of MID.

Advanced include start new selection: When using advanced include selecting a fixture will now deselect all fixtures and begin a new selection to unify standard selection rules across the platform.

Attribute editor naming consistency: The factory workspace shortcut to open the Attribute Editor workspace has now been renamed to 'Attribute Editor' for parity.

Previous fixture highlights end of selection: Pressing the previous fixture button will now highlight the end of the selection.

Renamed key profile +/-5% to Nudge Up and Nudge Down: The +/-5% key profile options have been renamed to 'Nudge Up' and 'Nudge Down' to avoid confusion.

Default timecode framerate 25: The default timecode framerate has been changed to 25 to avoid frame offsets increasing into invalid values.

16.1.5 Bugs fixed

Replace Palette Legend: Previously if you tried to set a legend when replacing a palette the old legend would persist. This has been fixed.

Renumber conflicts result in user number zero: Fixed an issue where renumbering over a range of items could result in all fixtures being set to user number zero if any were already in use.

Include runs individual channel fades: Previously if you included a playback with individual fade times it would run the fades. Include now ignores any fade times and snaps in.

Repatch fixtures spanning universes: Fixed an issue where it was not possible repatch a range of fixtures that spanned more than one universe.

Release shapes ignores master or user timing: Previously when releasing a playback that contained a shape the shape was removed instantly. It will now fade out using the master release or user timing.

Fade in, delay in "as in" removed: There was an issue where it was possible to set Fade in and Delay in to 'As In'. This has been fixed.

Replace doesn't fully remove previous fixtures: Previously when you replaced a cue it would not remove the unused fixtures. This could cause problems with filtered palettes and functions that rely on fixture order. This has been resolved.

Quick build lists don't track: Previously when cuelists were built using quick build they would not track correctly. This has been resolved.

Mode 3 cues don't crossfade to correct level: Fixed an issue where cues fading out by mode 3 were not at the level expected proportional to the mode 3 fader.

Palette IPCGBES update with off: Palette IPCGBES now update to accurately reflect content after attribute groups are completely removed via palette view.

Channel grid OFF key immediately deselects fixtures: Previously pressing OFF after selecting a cell in channel grid would deselect the fixture making it impossible to remove values this way. OFF now toggles attributes in selected cells off/on.

Copy cue list does not copy settings: Previously when you copied cuelists the fader mode would reset to default in the copy. Now when you copy a cuelist the fader mode is also copied.

Quick build cues appear empty in cue view: Fixed an issue where quick build cues were empty in cue view. You can now view and edit contents as expected.

Live update of key profiles above playback handles on touch screens: On touch consoles changes to key profile will immediately update in the playback touch display. Previously you had to change page before it would update.

Auto shared/normal confused after merge: Fixed an issue where the automatic shared/normal would be assigned incorrectly after merging a palette.

Deleting intensities in chases via cue view: Fixed an issue where dimmer values persisted in chases when they had been turned off via cue view.

Patching quantity leaves blank handle 30: Previously if you patched a quantity of fixtures that would span across physical handles on the Sapphire Touch or Pearl Expert certain handles would appear to be empty. This has been resolved.

TitanNet settings not clearing on new show: Previously when starting a new show TitanNet settings were not cleared and lines would be left assigned. These now reset.

FX mask does not represent effects: Cues containing pixel map effects did not show as containing FX in the indicator. Now they do!

Pressing ML while in Edit Palette exits and clears programmer:

On Sapphire Touch and Titan Mobile consoles attempting to enter the ML Menu from the Edit Palette menu would cause it to exit the Edit Palette function and clear the programmer. This has been resolved.

Patch active over manual gives error: Previously, attempting to link an active fixture by patching over the top of a manually patched fixture would result in an error prompt. It is now possible to link active fixtures by patching over manual.

Link chains: Previously if you created a number of playbacks that were linked to one another changes to the first playback would propagate to the second playback only. Now changes to a linked cue at any point in the chain will propagate across the whole chain.

Groups grey out when setting fixture order: Previously groups in the groups workspace would grey-out when setting fixture orders. This was misleading as groups can be used as part of setting fixture orders. They now stay lit.

Slow performance on large cuelists: Appending cues to cuelists would get progressively slower each time a new cue was added. In large cuelists this could become quite significant. Various improvements have been made to cuelist tracking updates to ensure this is no longer a problem.

Changing active cue to mode 1 results in delay then snap:

Fixed an issue where changing an active mode 0 intensity cue to a mode 1 with fade out would result in a delay then snap out. It will now fade out over the set time as soon as the cue is killed.

Patch selection does not remain after closing patch view:

Previously if you selected a fixture to patch in patch view and then closed patch view it would forget the selection. This was a problem if you needed to close the patch view to see the fixture workspace. Patch selection is now remembered after closing patch view.

Playbacks from legacy shows don't get user numbers: When loading shows from version 5 or earlier playbacks would not be assigned user numbers. This meant it was not possible to use the command line syntax to copy or move cues. Legacy show playbacks now have user numbers.

ST help menu missing: Fixed an issue where the help menu did not open the relevant options on the Sapphire Touch.

Mode 3 crossfade between identical values: Previously if you fired a timed mode 3 playback that contained some identical values as another active playback (for example 100% dimmer) the values would change when they should not. This has been resolved.

Pattern selection in edit times: Previously the times grid would highlight cells according to pattern selection but values input would ignore this and apply to all fixtures. This has been fixed and it is now possible to use pattern selections when editing times.

Channel grid does not update after sub-fixture exchange:

Previously if you exchanged a multi-cell fixture ghosts of the old fixture would remain if channel grid was open and the new fixture would not populate after closing/reopening. This has been fixed.

Master playback options: Attempting to set Playback Options would result in the previously selected handle being selected instead of the master handle. This made it seem like changes to masters

were not working. Setting Playback Options on master handles now selects the correct handle!

Master handle lock showing wrong in playback options:

Previously when first setting playback options on a newly assigned master handle it would incorrectly show as being unlocked. It will now show correctly as transparent lock (default).

Open visualiser theatre dialog hidden: Fixed an issue where the 'do you want to save theatre' dialog would be hidden when trying to open a visualiser theatre on Pearl Expert's without a wing connected. If you were not aware of the dialog waiting for an input it would seem as if Visualiser was unresponsive.

Patch view remembers fixtures after new show: Occasionally fixtures from an old show would persist in the patch view when starting a new show. This has been resolved.

Copy group picture legend: Previously copying groups would not copy any associated picture legends. This is now fixed.

Edits to cues via cue view don't work across linked playbacks:

Previously edits made to a cue via cue view would not propagate to linked playbacks. This has been resolved.

Snap back ignores OFF: Fixed an issue where snap back would ignore dimmers turned off and output them live.

v5 shows empty palette view: Fixed an issue where palettes from v5 shows would appear empty in palette view after restarting the software.

Auto shared/normal wrong if shared palette in programmer:

Palettes would automatically set to normal after selecting a shared palette for multi-celled fixtures. This was incorrect. Multi-cell shared palettes will now automatically record as shared as expected.

Shapes in cue lists conflicting: Previously if two cuelists set to control speed and/or size on fader both had active cues containing shapes with shared attributes (for example pan/circle respectively) either fader could master the speed or size of both cuelists. It has now been fixed so that the fader will only ever control its own shape or effect.

Auto group after fixture exchange not selecting all fixtures:

After exchanging a fixture the auto groups would not select all fixtures correctly. This has been resolved.

User number sorting: Previously sorting columns containing numbers such as user number would not order as expected. This has been fixed.

Patch view addresses remain after park: In certain situations the display would not update the fixture address correctly after parking fixtures and could still show the previous address. This could make readdressing confusing. This has now been resolved.

LED fixtures reset to black after highlight: After using highlight on LED fixtures they would go black. This is now fixed.

Vis delete auto update: Previously deleting a fixture would not delete it from Visualiser when in auto update mode. This has been fixed.

Review does not play back last cue with fade times: The review function stopped working in previous versions. Now pressing review will cause the previous cue to play with its times.

Blade index reset control doesn't work: Fixed an issue where the blade index and reset controls were not working properly in attribute editor.

No preset palettes after delete/repitch: Previously if a fixture patched with preset palettes enabled was subsequently deleted they would not be recreated if the fixture was patched again. This has been fixed.

Load progress shows twice for T1 with no dongle: Fixed an issue where the load progress bars would be shown twice when loading a show in Titan 1 with no dongle present.

No option to run shapes on cells when selected from shapes workspace: Previously if you selected a shape from the shapes workspace there was no prompt to run on super fixture or sub fixtures for multi-celled fixtures. This now works correctly.

THRO and AND fixture order for cells: If you used THRO and AND to select cells the resulting fixture order would not be correct. This has been resolved.

Include current step: When including step 0 represents the current step. In previous versions attempting to do this would fail with an error message. It is now possible to include step 0.

Shapes and chases pause during save or autosave: In previous versions shapes and chases would pause during save operations for large shows. They will now run without interruption.

Ampersand in personality manufacturer name: Previously if a show contained a fixture where the manufacturer name contained an ampersand character it was not possible to copy the fixture and the show would fail to load properly. These issues have been resolved and the ampersand character is permitted.

Problems changing MID options in cue view: After setting a MID option in cue view, selecting other MID cells would cause them to immediately change to the setting used previously. If a new MID cell was selected without committing a change to the first cell selected the cue row would highlight in red which would never go away and the original cell would still be being edited. These issues have been resolved.

Inactive cuelists intensity indicator: Previously inactive cuelists would show as containing intensity with an 'I' in the playback on touch consoles. The ICPGBES indicator is now always empty for inactive cuelists.

Unable to repitch/park generics: Fixed an issue where it was sometimes not possible to park dimmers using the repitch function when they were marquee selected in the fixtures workspace.

Patch with offset into gaps: Attempting to patch fixtures into gaps using the offset function would not work properly. This has now been resolved.

Exchange fixture loses picture legend: Previously when exchanging a fixture associated picture legends would be replaced with default fixture text. The picture legend will now remain.

Exchange from cells -> no cells and back loses control of cells:

Previously if you exchanged from a fixture with cells to a fixture without cells and back again you would no longer be able to select cells in the attribute editor. This has been resolved.

Flash with timing over similar playbacks: Previously if a timed playback containing attributes shared with an active playback was flashed momentarily the shared attributes would snap back to a value somewhere between the original playback and the flashed playback, dependent on the fade time and amount of time the flash button was held. Now values in the timed playback will assert themselves as soon as flash is pressed and stay there.

Exchange from fixture workspace including empty handles:

Previously if you selected fixtures in the fixtures workspace using a marquee that spanned an empty row the empty handles would be counted during a fixture exchange which could cause potentially conflicting fixtures to be parked unnecessarily. Gaps are now ignored and the number of fixtures for exchange are counted correctly.

Vis theatres always auto update and do not load correctly from shows: Fixed an issue where visualiser would auto patch fixtures even when update was turned off.

THRO bypasses lock: Fixed an issue where pressing the THRO key would temporarily bypass console lock.

Copy large cuelist: Fixed an issue where large cuelists would take a very long time to copy and would appear to have not worked.

Includes all shapes regardless of fixture selection: Previously if you tried to filter included shapes by fixture it would ignore the fixture selection and include all shapes for all fixtures. It is now possible to include shapes for the selected fixtures only.

Move cues out of order: Previously if you moved cues in the playback view using command line syntax it would not reorder until you scrolled through the cues in the connected playback view. Moving cues now reorders live.

Shape search: Occasionally it was not possible to enter text to filter shapes. This has been resolved.

View scroller+dimmer = exception: Previously if you tried to view a fixture that contained a pending dimmer the fixture view would throw an error. This has been fixed.

Fractional fades: Previously values after a decimal point would be ignored for fade out and delay out in cuelists. Values after a decimal point now work correctly.

Cue list update slow: Fixed an issue which meant it could take a long time to update a tracking cuelist.

OFF fixtures record by fixture: Previously if you turned a fixture off prior to recording it would still record. Now fixtures turned off will be ignored when recording on an empty handle.

Numeric palettes to use master times: Previously recalling a numeric palette from the palette menu would ignore the master overlap setting. This has been resolved.

Fixture workspace show DMX reverts to hide after patch: Fixed an issue where the fixture workspace context option to show DMX address would revert to hide after going into the patch menu.

Dimmers do not fade by fader when merged into referenced palette: If a dimmer was merged into a palette with user setting [add new palette channels to playbacks] enabled, firing a cue that referenced the palette would cause the dimmer to snap and ignore the fader level. This has been fixed.

View normal palette order: Normal palettes had a strange order when viewed. This has been resolved.

Park multiple dimmers: Parking multiple dimmers via repatch would only park the first dimmer. Parking multiple dimmers now works correctly.

Install usb expert over old versions: Previously there was an installer issue where it would think the new version of Usb Expert was older than the existing one and not install. This has been resolved.

Update personality turns fixtures off: Fixed an issue where updating a personality would result in all channels needing a nudge before they would work properly.

Duplicate fixture orders: Previously groups containing duplicate order numbers (ie. 1,1,1,1,2,2,2,2) would not take for cues or shapes and the order would be replaced with unique order numbers. Duplicate fixture orders will now record in cues and apply to shapes as expected.

Channel grid wheels sync with cell selection: Previously selecting attribute cells in the channel grid that spanned pages within the associated attribute group would not update the connected wheels and cause them to be out-of-sync. Now whenever a cell is selected the wheels will be connected to the correct attribute.

TitanNet - load and save and startup order: Previously you could lose your work or get a broken startup if you didn't power the TitanNet system on and off in the correct order. Now if a node is shut down it will automatically save the show to prevent this.

Art-Net doesn't always output data: Fixed an issue where the default adapter in multiple network adapter situations (ST and Pro consoles) was not always the local area network which would result in Art-Net not appearing to work.

Load bar appears to hang at end on Sapphire Touch: Fixed an issue where the load progress bar on a Sapphire Touch would pause for a long time at 100%.

Lamp intensity LCD update: Fixed an issue where the lamp intensity control would not reflect the actual level on start.

Off size/speed out of programmer representation: Previously if you turned shape size or speed off all the shape controls would lose their in-programmer highlights. This has been fixed.

Append intensity cues with tracking turned off: Previously if you appended (or inserted) an intensity cue in a list with tracking turned off, the intensity would not record correctly if it already existed in the preceding cue. This has been fixed.

Backwards selection loses last fixture: Fixed an issue where numerically selecting fixtures in reverse would cause the last fixture to be missing from the selection.

Firing new cues causes previous incomplete fades to use new times: Previously if a cue had not completed its fade when the next

cue in the list was fired it would fade in using the timing from the new cue. Now the cue will continue to fade with its own time.

Selecting sub fixtures from the root menu does not work:

Previously it was not possible to use the '[n].' syntax to select sub fixtures from the root menu. This is now possible.

Normal intensity palettes are incorrectly set to shared automatically:

After recording an intensity palette, any subsequent intensity palettes will always automatically set to shared. This has been resolved.

Personality - case sensitive manufacturer name: Previously if there were personalities in the library that contained the same manufacturer name but with different cases you might not be able to patch. This has been fixed.

Multiple block all shapes: Previously it was possible to have multiple block all shapes in a cue. This has been fixed.

Repatch dimmer cells: Previously attempting to repatch multi-dimmer celled fixtures from the patch/repitch menu would fail. This has now been fixed.

Reverse numeric selection: Previously when selecting fixtures in reverse numerically the last fixture would not be selected. This has been fixed so that all fixtures are selected as expected.

Set legend on playback view selects wrong cue: Previously if you used [Set Legend] and then touched a legend cell in playback view it would jump to the first cue. This has been fixed so that it selects the cue expected.

Shapes and effects in quick build: Previously it was not possible to quick build cues from shape or effect cues. This has now been fixed.

Add shapes to palettes: Previously when adding shapes to palettes with user setting 'add new palette channels to playbacks' enabled any cues containing the palettes would not update to show the shape. This has been resolved.

16.1.6 Known issues

Remote sync: Currently changes to things like legends, user numbers and DMX addresses will not synchronise between the console and remote unless you restart or reconnect the app.

16.2 Version 6.2

16.2.1 Upgrading from: 6.1:

Please download the upgrade installer from our Avolites download website. Once the download completes, run the installer on the console and follow the instructions.

16.2.2 Improvements

Tiger Touch Pro and Pearl Expert Pro Panel Layout: A new panel layout for the Pro series of consoles re-arranges the function keys to better align with other consoles in the Titan range.

- Record
- Update
- Include
- Edit
- Copy
- [Shift] + Copy = Move
- Delete
- Fan
- Unfold
- Off
- Release
- Patch
- Disk
- [Shift] + Disk = System

To activate the new panel layout the Program Panel id must be changed to index 2 in USB Expert. In addition the [Include] key is now [Macro] above the keypad.

Tiger Touch View Key: On the Tiger Touch console with the Pro upgrade the View key is now above the numeric pad rather than to the right.

16.2.3 Changes

Tiger Touch Lamp Intensity: You can now adjust the lamp intensity on the Tiger Touch console from the system menu. Change to system menu and then use Wheel A to adjust the lamp brightness. Please note you must have the Pro upgrade installed for this feature to work..

Tiger Touch Wheel @ Buttons: You can now use the buttons next to the wheels as @ buttons. This allows you to set attributes by numeric value or select a specific attribute from a list.

Tiger Touch Flash On, Rem Dim, Wheel Scroll: The three keys above the wheels have been changed to the following functions.

- Flash On (Shift = Flash Out)
- Remove Dimmer
- Wheel Scroll Lock

16.2.4 Bugs fixed

Personalities in User Folder not loaded: The console was not loading personalities from the users personality folder. This meant that custom personalities did not appear when patching.

New show would sometimes fail to reset console: Occasionally after a new show the settings were not reset to the correct value. The console would require a second New Show to be setup correctly.

Updating a cue in a cue list occasionally showed poor performance: Updating a cue in a large cue list could sometimes take a long time making the console seem unresponsive.

16.2.5 Known Issues

Art-Net default adaptor is Local Area Connection 2:

If Art-Net is set to output on the 'Default' adaptor on new consoles that have two network ports then it will output only on local area connection 2. For Art-Net output you should use the right hand connector as you look from the rear of the console or manually select Local Area Connection 1 in Art-Net settings.

16.3 Version 6.1

16.3.1 Upgrading from: 6.0:

Please download the upgrade installer from our Avolites download website. Once the download completes, run the installer on the console and follow the instructions.

16.3.2 Changes

Avolites watermark: We have added the Avolites logo as a watermark to the prompt area.

Pearl Expert wing settings: Re-instated the Pearl Expert wing connection menu.

16.3.3 Bugs fixed

Loading show not presenting error report: Sometimes if errors occurred while loading a show the console would not present these errors to the user.

Motorised fader update when changing page: If you changed page on a console with motorized faders they would not always return to zero. This depended on whether a handle was present on the new page.

Cue numbers with 3 decimal places get truncated: Using cue numbers with three decimal places would result in a truncated cue number different from that specified.

DMX nodes not being displayed: Occasionally when you loaded a show the DMX view would show no nodes attached. The nodes were present but they were not displayed.

Copying fixtures cells removes DMX address from source: When copying fixtures which contain cells the original fixtures would lose their DMX address and the original would need to be re-patched.

Loading large shows would timeout: When loading a large show it would timeout and incorrectly state that the show have failed to load. The show loading speed has been increased as well as stopping this from happening.

Delay entering times and attribute times menu: Sometimes there would be a long delay before the times and attribute times menu would open. This was in the order of 20 seconds.

Large shows not loading correctly: Very large V5.0 shows would not load correctly into V6. This has been fixed.

Console would not shutdown: Sometimes the console would not shutdown correctly and would ask the user to force shutdown. This had no adverse effect on the console and has now been resolved.

Upside down second screen: When connecting an external monitor the screen would sometimes appear upside down.

Palettes on celled fixtures: Sometimes when applying palettes stored on celled fixtures the applied palette would not output as recorded.

Cue list copy ignoring tracked value: When copying a cue list the tracking information was not being copied correctly which rarely resulted in the cue list outputting incorrect levels.

Changing IP address stopped Art-Net: Changing the console IP Address would stop Art-Net output until you refreshed the settings.

Autosave disabled lost after restart: The autosave enabled setting would sometimes reset after restarting the console.

Patch view failed to initialise: Sometimes when opening the patch view window you would see a failed to initialise error. Re-opening the window would fix.

Record by stage on celled fixtures: Record by stage would not record fixtures where only the master had intensity.

Colour wheel shapes not working: Shapes that used a fixtures colour wheel would not run correctly.

Update personality and user number selection: After you updated a personality for a fixture you were no longer able to select that fixture by user number.

Occasional pause in shapes and pixel mapper: Very occasionally and after a while of the console being on you may see a brief pause of around 500ms in all shapes and pixel maps. This would more often than not appear when firing or killing other playbacks.

17. Glossary of terms

ADDRESSES	The DMX Channels occupied by individual Fixtures. The first Channel occupied is usually encoded onto the Fixture somehow (often by switches or using a menu) and called its ADDRESS.
ALIGN	A means of copying Attribute characteristics from the first Fixture selected to other selected Fixtures, resulting in the Fixtures being aligned to each other.
ATTRIBUTE	One Channel or function of an Intelligent Fixture, such as "Colour Wheel".
ATTRIBUTE GROUPS	see IPCGBES.
AUTOLOAD	A playback which is automatically fired by a cue in a cue list. Enables a chase to be fired by a cue list.
BACKUPS	Copies of a show stored to an external storage device for safety.
BPM	Beats Per Minute. 60 BPM is equivalent to one step per second.
BUSKING	Operating the console live (usually for live music) when you have insufficient programming and need to make up stunning effects as you go along using palettes etc.
CHASE	A sequence of one or more pre recorded steps which automatically run one after the other.
CHASE STEPS	Individual cues within a Chase. See above
COLOUR CHANGER	A mechanical Fixture for changing the colour of a light source, usually by scrolling through a roll of different coloured gels or by moving special filters into the light beam.
COLOUR MIX / CMY	A system of three filters that can each crossfade from white to a colour, or one colour to another. It is a feature of most Intelligent Fixtures, which enables thousands of different colours to be created.
CONNECTED CHASE	A Chase which has been brought under control of a chase Controller by pressing the CONNECT button.
CUE	A single stage look programmed onto a Playback button or fader. Also known as MEMORY, STATE, SCENE, LOOK.
CUE LIST	A sequence of cues programmed onto a Playback button or fader. Each cue can have its own delay and fade times and can also start other cues or playbacks. Also known as a CUE STACK or STACK.
CUE MODE	A playback format programmed into a Cue. There are Cue Modes 0 - 3.
DEVICE	See FIXTURE.

DIMMER	Device used to control the intensity of an individual light.
DMX	DMX512(1990) a specification for communication between control desks and Fixtures, Originally for Dimmers it has been adopted as a control protocol for most Intelligent Fixtures. It can carry 512 different Channels of data.
FADE	A continuous transition from one level to another.
FIXTURE	Any lighting instrument that is patched using a Personality. Generally refers to a moving light or colour changer, not an individual Dimmer channel. Also called Intelligent Fixture, Device, Instrument, Moving Light.
FLASH	Pushbutton which adds a playback into the existing output of the console. Historically called the ADD button. See also SWOP.
FLIP	A function for use with Moving Head Fixtures. They have two possible Pan and Tilt positions for each point on stage, and FLIP will alternate between them.
FOCUS	What Palettes used to be called on older Avolites consoles. See PALETTE. May also be used in connection with moving fixtures to focus (set the sharpness) of a gobo projection.
FUNCTION WHEEL	A wheel which does not directly control an Attribute channel on a fixture, rather it controls only part of an attribute and another function wheel may control other parts. For example a rotating gobo attribute may have one function wheel to control continuous or indexed mode, and another function wheel to control rotation speed or position, though the actual fixture only uses one DMX channel to control both these functions.
GENERIC	Term used to indicate a Dimmer channel. See also FIXTURE.
GROUP	A GROUP is a pre-programmed collection of Fixtures that can be selected with a single button press.
HTP	Highest Takes Precedence, a mechanism for determining the output level of a channel being controlled by more than one Playback. The Playback outputting the Highest value at any given time will determine the level of the channel. Also see LTP.
HUD	Heads-up-display, an information window shown on the screen.
INCLUDE	A means of transferring the contents of a Cue or Chase Step into the Programmer.
INSTRUMENT	See FIXTURE.
INTELLIGENT FIXTURE	See FIXTURE.
IPCBES	The Attribute Groups, used by the console to conveniently group together similar attributes. For

	example the P(osition) group includes Pan and Tilt attributes.
LCD	Refers to the console's on-board displays (stands for Liquid Crystal Display).
LED	Refers to the small lights within the buttons on the console (stands for Light Emitting Diode). Also a much brighter LED is used as the light source in some intelligent fixtures.
LINKS	Connections between cues in a Cue List or Chase enabling them to run on from one to another automatically.
LOCATE	A feature of the console that makes it easy to find your selected Fixtures by putting them in Open White. Pressing Shift+Locate additionally sets the Pan and Tilt at 50%.
LTP	Latest Takes Precedence, a mechanism for passing control of a channel from one Playback to another on the basis that the latest Playback Fader to be moved has control, providing that Playback Fader has moved past the Trigger point. (See TRIGGER POINT). Also see HTP.
MACROS	Macros allow functions programmed into an Intelligent Fixture by the manufacturer to be executed by sending a DMX command sequence from the console. They can allow you to reset the Fixture for example. The DMX command sequences are defined within the Personality File. Also used in Titan to refer to a stored sequence of button presses.
MEMORY	The name for a Cue on older Avolites consoles.
MIDI	Stands for Musical Instrument Digital Interface. It is the established hardware and software specification enabling the exchange of data between digital musical instruments (such as keyboards) and other devices such as computers, sequencers and sound and lighting consoles.
MENU LATCH	Provides functions for control of Moving Lights (Moving Light Menu).
ON and OFF	Any channel stored in a playback can be On or Off. A channel which is ON is changed by the playback when it is fired. A channel which is OFF is stored in the playback for future re-use but has no effect when the playback is fired.
OVERLAP	Sets how the console allocates new values to a group of fixtures. 100% means that all fixtures are updated simultaneously. 0% means that the fixtures will be updated one after the other.
PALETTE	A term used to describe a referenced pre-defined state for an Attribute that can be recalled whenever required during programming. Each Fixture may be set to a different value in the Palette, the entries can be named, and recalled with a single button press.

PARK	A Parked fixture is one which is patched to a handle but has no DMX address set. This happens to a fixture when its DMX address is taken by another fixture during a later patching session; the Repatch function is used to give it a new DMX address.
PERSONALITY	A description of what Attributes a particular Intelligent Fixture has and how the console will patch and use these. It also determines which Attribute Wheel will control which Attribute.
PLAYBACK	Area of the console that can replay recorded Cues or Chases using Playback Faders.
PRELOAD	A playback button which sets the LTP channels in a cue but not the HTP channels. Used to pre-position fixtures before firing a cue. Also a cue list function which allows one cue to preload the LTP channels in another cue.
PRESET FOCUS	The old name for Palettes on previous Avolites consoles. See PALETTE.
PROGRAMMER	The part of the console which contains Channel information which has been changed by the user, prior to recording.
SAFE	Desk mode in which all Playback functions are enabled, but all programming functions disabled.
SELECTED	A Fixture that is under manual control.
SEQUENCE	See CHASE.
SHAPE	A preprogrammed effect available which is applied to an Attribute. It can then be customised and stored in a Cue.
SHARED PALETTE	A Palette in which information is only stored for one Fixture, but is available to all Fixtures of that type.
SOFTKEY	Menu buttons marked A-J, which have different functions depending on the currently active menu.
STACK	Old name for a CUE LIST.
SWOP	Type of flash button which turns on the output being flashed and turns off all other output while the button is pressed. Sometimes called "Solo". Also used for selecting fixtures or playbacks when programming. See also FLASH.
TABLE	List of pre-defined levels for an attribute allowing settings to be recalled by name (for example the colours available from a colour wheel may be found in a table).
TIMECODE	An electronic timer signal which allows cue list playback to be synchronised to a soundtrack or other events. The console can read MIDI timecode or can take a timecode from the Windows sound player application "Winamp". An internal free-running timer is also provided.

TRACKING	Describes the operation of Cue Lists where lighting states follow through from previous cues unless changed by the user.
TRIGGER POINT	The level set in the User Settings which determines at which point a Playback Fader triggers the LTP Channels programmed onto it.
UNFOLD	A function that allows Chase Steps to be laid out onto Playback Faders for easy editing.
USER SETTINGS	User definable desk settings. To change them, hold down the Avo button and select [User Settings].
VIRTUAL DIMMER	Used with LED RGB (red-green-blue) colour mixing fixtures, these add an intensity function to the fixture which masters the RGB controls on the fixture when it does not actually have an intensity control channel.
WIPEALL	A process which clears all the previous programming out of the desk, but does not touch the System Software.
WHEEL	Wheels are used on the console to set Fixture Attributes and to control chases and cue lists (see FUNCTION WHEEL).

Index

Softkey Menu items are indicated with capital letters (for example "Activate A Timecode Cuelist")

@

@ button · 69

A

acceleration mode of wheels · 66
 ACDI, connecting up · 210
 active fixture
 media thumbnail · 67
 active fixtures · 211
 Add Swop button · 170
 adjust attribute values · 69
 Align fixtures · 75
 All button · 75
 always merge · 130
 Append · 145
 Append Cue (cue list) · 152
 Apply Time To Palette · 172
 Art-Net, setting up · 207
 As In · 160
 assign mastering · 192
 attribute editor window · 66
 attribute groups · 72
 attributes
 controlling · 64
 entering numerically · 68
 setting · 64, 65
 auto connect chase · 191
 auto groups · 48, 73
 auto legend · 85
 autoload playback in cue list · 153
 autosave options · 41

B

backing up show · 42
 backup · 177
 banks of attributes buttons · 64
 Blind mode · 126
 block shape · 93
 Bunch Up · 56, 90, 134
 busking · 172

C

cells / sub fixtures · 63
 channel button · 69
 channel grid window · 80
 chases
 appending new cues · 145
 connecting · 143
 cue linking · 149
 cue, fixture and attribute overlap · 148

deleting · 134
 difference between chase and cue list · 151
 direction · 144
 editing using unfold function · 145
 global timing · 146
 individual cue times · 148
 inserting cues · 145
 pausing · 144
 recording · 141
 running · 142
 speed and crossfade · 143
 tap tempo · 147
 temporary speed · 143
 CITP · 211
 clear button · 62
 Clear button · 125
 clearing the console · 42
 colour picker · 66, 67
 compatibility view · 187
 connect button · 143
 copy chase · 146, 159
 copy cue · 133
 copy palette · 90
 copying
 fixtures · 56
 crossfade of chase · 143
 cue list
 append cue · 152
 attribute fade times · 162
 autoload · 153
 cue legends · 153
 default delay/fade times · 151
 difference between chase and cue list · 151
 editing cues and times · 158
 fire first cue · 167
 keyboard shortcuts · 154
 killing · 155
 macro link · 154
 move cues · 156
 move in dark · 166
 recording · 151
 setting times · 160
 update · 158
 Cue Overlap · 148, 161
 cue view · 130
 cues
 attribute fade times · 137, 149
 changing page · 127
 deleting · 134
 editing · 129
 fade modes · 136
 flashing · 127
 include function · 132
 playing back · 127
 recording · 125
 removing attributes · 132
 setting fade times · 134
 setting legends · 125
 curve · 139
 curves · 194
 curves, fan · 77
 curves, fixture or attribute · 58
 custom/user fixture personalities · 203

D

Delay Time · 136
 delete palette · 91
 deleting
 chase · 134
 cue · 134
 deleting patched fixtures · 56
 desk lamps · 25
 DHCP · 214
 dimmer, virtual · 66
 dimmers
 entering numerically · 69
 patching · 45
 display setup · 192
 DMX address
 displaying for fixture · 45
 setting for fixture · 47
 DMX output mapping · 192
 DMX outputs · 24
 DMX Settings · 192
 DMX triggering · 174
 DMX workspace window · 53

E

Edit Times · 134
 editing a cue · 129
 editing values · 80
 Editor · 124
 effects generator · 93
 effects palette · 87
 enter numeric values · 68
 external monitor · 187

F

fade curves · 194
 Fade Out Time · 136
 Fade Time · 136
 fade times for cues · 134
 fading palettes · 91
 fading palettes over time · 172
 Fan button · 76
 Fan curves · 77
 filtered palettes · 88
 find fixture · 49
 firing a chase · 142
 fixture exchange · 54
 fixture layout · 73
 fixture macros · 81
 fixture order · 136, 162
 fixture order in a shape · 101
 Fixture Overlap · 136
 Fixture Overlap (chases) · 147, 162
 Fixture Overlap (cue lists) · 162
 fixture overlap (palettes) · 172
 fixture overlap with palettes · 92
 fixture page buttons · 45
 fixture personalities, custom · 203
 fixture personalities, downloading
 and installing · 202
 fixture select buttons · 44
 fixtures
 changing page · 61
 groups · 72
 locating · 61
 patching · 46
 step through selection · 75

Flash Full/Flash Out · 75
 flash with times · 170
 Flip · 76
 freeze fixture or attribute · 59

G

Generic fixtures · 204
 global chase timing · 146
 go and stop · 144
 Go button · 155
 grand master fader · 168
 group
 fixture layout · 73
 Group button · 72
 group masters · 169
 grouping fixtures · 72

H

handle paging · 139, 165
 HiLight button · 75
 HTP and LTP, explanation of · 127

I

import show · 40
 Include button · 132
 Insert (in unfold mode) · 157
 Insert (rec chase) · 145
 insert chase step · 145
 Invert attributes · 57
 IP address, setting · 206
 IP addressing explained · 212
 IPCGBES groups · 72
 iPod/iPhone · 179

J

jump to step in chase · 144

K

key modes · 168
 key profile
 individual for playback · 140, 165
 key profiles · 188
 keyboard not working · 35
 keyboard shortcuts · 35
 keyboard, external · 25

L

latch menu · 30
 latching the copy menu · 134
 latching the rec cue menu · 125
 layer masters · 100
 LED brightness · 191
 legend button · 85
 legend, pictures · 86
 legends

setting for fixtures/dimmers · 53
 legends for cues in cue list · 153
 level matching of playbacks · 128
 limiting attribute range · 58
 Link (cue lists) · 160
 Link Offset · 160
 Load Show · 38
 loading a show · 38
 Locate button · 61
 locate, record new state · 62
 lock playback on handle · 139, 165
 lock the console · 36
 LTP and HTP, explanation of · 127

M

macro in cue list · 154
 macro, link to cue · 165
 macros · 81
 macros (keypress) · 34
 mask
 clear · 62
 mask, toggle groups · 84
 master faders · 168
 master faders, assigning · 168
 master overlap (palette) · 92
 master palette overlap · 92
 master palette time · 92
 master time (palette) · 91
 media servers, setting up · 211
 midi connections · 25
 MIDI timecode options · 191
 MIDI triggering · 174
 mode 0 - 3 for cues · 136
 monitor · 187
 mouse, external · 25
 move chase · 146, 159
 move cue · 133
 move function · 173
 move in dark · 166
 move palette · 90
 moving cues in cue list · 156
 Moving fixture · 56
 Multi-DMX fixture · 204
 multiple dimmers on one handle · 46

N

network backup · 177
 network connection · 25
 New Show · 42

O

Off button · 132
 offset, DMX patching · 47
 operate mode · 168
 order of fixtures · 136

P

page
 selecting fixture pages · 45
 page buttons · 88

page buttons, use in set list window
 · 174
 page legends · 53, 128
 pages of cues · 127
 pages of fixtures · 61
 pages of palettes · 88
 pages show/hide button · 45
 palette
 auto legend · 85
 Palette Bank buttons · 88
 palette fade button · 92
 palettes · 82
 creating · 83
 editing and deleting · 89
 fading over time · 91, 172
 fixture overlap · 172
 master overlap · 92
 master time · 92
 recalling · 88
 setting legends · 85
 update · 90, 130
 viewing values · 89
 park fixture · 52
 patch view window · 50
 patching
 attribute limits · 58
 copying fixtures · 56
 curves · 58
 deleting fixtures · 56
 dimmers · 45
 edit personality · 59
 fixtures · 46
 freezing attributes · 59
 inverting attributes · 57
 setting legends · 53
 sub fixtures · 48
 swap pan and tilt · 57
 Patching, show DMX channels · 45
 pattern selection · 70
 pausing a chase · 144
 pearl expert shows · 187
 pending dimmer · 47
 personality, editing · 59
 phase of shapes · 97
 phase offset · 97
 picture legend · 86
 picture legends · 28
 pixel mapper · 97
 layer masters · 100
 pixel mapper examples · 102
 pixel mapper preview · 99
 playback options
 chases · 149
 cues · 138
 playback priority · 139
 playback view · 130
 playbacks
 releasing · 129
 preset palettes · 48
 Prev/Next buttons · 75
 priority setting for playback · 139
 Programmer · 124
 prompt for merge · 190

Q

Quick build · 142
 quick build cue · 126
 quick palettes · 88
 quick record · 28
 palette · 85

R

RDM · 49
 Rec Step button · 158
 Rec Times button · 158
 Record (in unfold mode) · 145, 157
 Record Chase button · 141
 Record Cue button · 125
 recording macros · 34
 reinstalling software · 198
 release mask · 138
 releasing playbacks · 129
 Rem Dim · 75
 remote control · 179
 remote trigger · 174
 remove fixtures from a shape · 101
 reports · 42
 resetting fixtures · 81
 Retain Layout · 56, 90, 134
 running a chase · 142

S

safe mode · 168
 Save Show · 38
 saving show to hard disk · 37, 40
 Select a DMX line · 47
 Select Cue · 160
 Select Fix Page button · 61
 select if · 71
 selecting fixtures in a pattern · 70
 Set Cue Times (in unfold mode) · 146
 Set Fixture Order · 162
 Set IPCGBES Times · 137, 149
 Set Legend button · 53, 125
 set list window · 173
 Set Out Time · 160
 setting attributes · 65
 Setup button · 37, 40
 shape generator · 93
 shape palette · 87
 shape speed and size · 96
 shapes
 deleting · 102
 editing shape in a cue · 100
 fading in · 102, 139
 fixture order · 101
 phase · 97
 reversing · 102
 shapes window · 94
 shortcut keys · 35
 show file
 saving and loading · 38
 simulator · 36
 Snap Back button (cue lists) · 155
 software, recovery · 198
 software, upgrading · 198
 Speed (chase) · 147
 speed masters · 128, 169
 speed of chase · 143
 spread of shapes · 97
 Stop button (cue lists) · 155
 Store Palette · 83
 sub fixtures · 48
 sub fixtures, selection · 63
 swap items if required · 56, 91, 134
 Swap Pan Tilt · 57
 system menu · 190

T

tap tempo · 147
 tempo units · 190
 temporary chase speed · 191
 temporary speed · 143
 text size · 191
 theatre mode · 151
 timecode · 163
 times, setting into programmer · 138
 Titan simulator · 36
 TitanNet overview · 194
 toggle mask · 84
 touch button size · 191
 transparent lock · 139, 165
 Triggers · 192

U

undo/redo · 34
 unfold
 cue list · 157
 Unfold button · 145
 Unknown fixtures · 204
 unlinking chase cues · 148
 update · 90, 130, 158
 update personalities · 55
 upgrading the software · 198
 UPS · 23
 user number · 45
 user settings menu · 190

V

VDU · 187
 VDU screen
 connecting · 25
 view DMX output · 53
 view menu · 173
 viewing key profiles · 188
 virtual dimmer · 66
 Visualiser · 33
 Visualiser auto patch · 48

W

warn before parking fixtures · 190
 Wheel sensitivity · 191
 wheels
 acceleration · 66
 controlling attributes · 65
 fast mode · 66
 wheels= softkey · 79
 window positions · 26, 28, 185
 Wipe · 191
 wipeall · 42
 workspace
 positioning windows · 26, 185
 saving · 28, 186
 window options · 28

X

X in fixture order · 137

Avolites Titan Operator's Manual (Tiger Touch version)

part number **8200-3000**

Price £30

Additional copies of this manual, together with other useful spares etc. can be purchased through the Avolites On line shop. Visit <http://www.avolites.com> then navigate to Avo Shop from the links on the left hand side.